

QST

DEVOTED ENTIRELY TO

AMATEUR RADIO

Published by the American Radio Relay League

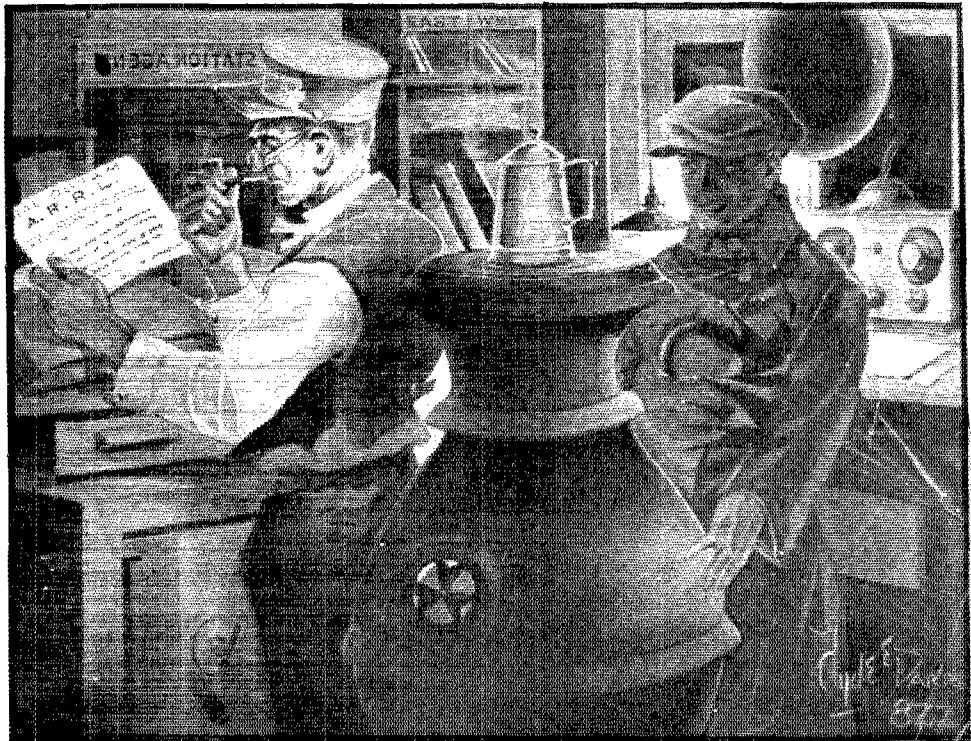

AMATEURS GIVE EMERGENCY SERVICE FOR RAILROADS WHEN WIRES ARE DOWN.

MAY
1926

25¢

Cunningham

RADIO TUBES



Leadership

The radio store that sells Cunningham Radio Tubes is a leader in its community—Its dominant policy is to serve and protect its customers, to give them utmost value, and the ultimate degree of radio satisfaction.

Of course—a store of this sort is quick to appreciate the Invisible Integrity, the In-built Value, of Cunningham Radio Tubes. Its management knows that for eleven years these tubes have never failed; that no compromise or short-cut has ever endangered their reputation or their superlative service to the public.

No wonder that progressive dealers prefer to sell a product of such outstanding merit.

In the Orange and Blue Carton

E. J. Cunningham Inc.

New York

Chicago

San Francisco

Manufactured and sold under rights, patents and inventions owned and/or controlled by Radio Corporation of America.

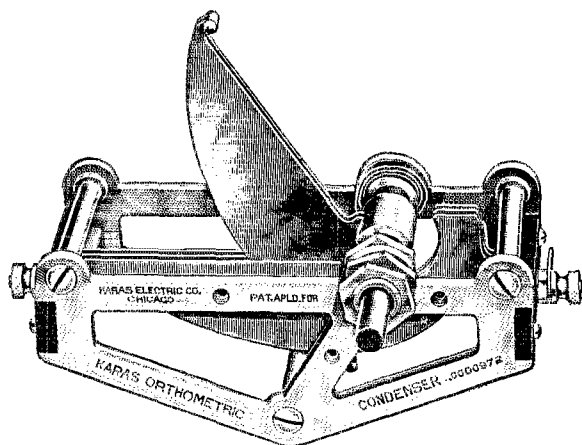

The KARAS ORTHOMETRIC Straight-Frequency-Line Condenser

Designed Particularly for Short Wave Work

Karas has taken the lead in developing condensers to meet the exacting requirements of short wave work. Karas builds the only 140 mmfd. condenser on the market. Karas Orthometric 5 and 7 plate condensers were built at the suggestion of Lieut. F. H. Schnell and have been enthusiastically approved by him.

How many short wave experimenters appreciate the extremely exacting condenser requirements of a short wave set? How many realize that many condensers, satisfactorily adapted to the broadcast range, will prove quite worthless in short wave reception?

At 10 to 40 meters, radio energy performs many queer tricks. The dielectric MUST neither leak or absorb energy. It must be highly efficient as a dielectric, and be placed well without the effective electro-static field. The plates must hold the charge without variation. All these things are well accomplished in the design and construction of Karas Orthometric short wave condensers. They are as nearly perfect both electrically and mechanically as it is possible to build condensers.

The accurate straight frequency line characteristics of Karas Orthometrics are vitally important in short wave work. Think of it! There are as many channels of 10 kilocycle separation between 50 and 60 meters as there are between 200 and 500 meters.

Mechanical accuracy is vital. Slight variations in plate spacing that might be immaterial in broadcast work would upset frequency control at the tremendously high frequencies with which the

short wave set has to deal. The spring pig tail connections on the 5 and 7 plate condensers are insulated to prevent contact noises at extremely high frequencies.

Karas Orthometric Condensers are mechanical masterpieces. They go far beyond the standards of accuracy heretofore considered necessary in condenser construction.

You will probably want one or two stages of audio in your short wave receiver. You cannot beat Karas Harmonik Transformers. Include one or two transformers with your order. They are \$7.00 each.

Specifications of Karas Orthometric Short Wave Condensers. Price \$6.50 each

5 plate	Max. Cap. .0001 mfd.
	Min. Cap. .00001 mfd.
7 plate	Max. Cap. .00014 mfd.
	Min. Cap. .0000108 mfd.
11 plate	Max. Cap. .00025 mfd.
	Min. Cap. .0000115 mfd.

Also—

Karas Orthometric Condensers for Broadcast Receivers.

23 plate, .0005 mfd. price \$7
17 plate, .00035 mfd. price 6.75

Karas Harmonik Transformers, price \$7.00.

KARAS ELECTRIC CO.
Manufacturing Plant: N. Rockwell St.
Offices: 1070 Association Bldg.,
Chicago, Ill.

Karas Electric Co., 1070 Association Bldg., Chicago.

Please send me.....Karas Harmonik Transformers and

.....Karas Orthometric Condensers,
sizes as checked below. I will pay the postman the price plus postage upon delivery. It is understood that I have the privilege of returning these condensers and transformers for full refund any time within 30 days if they do not prove entirely satisfactory.

..5 plate; ..7 plate; ..11 plate; ..17 plate; ..23 plate.

Name

Address

If you send cash with order, we'll ship condensers and transformers postpaid.

Order Through Dealer or, Direct on This Coupon

Karas Condensers in the 23, 17 and 11 plate sizes are generally sold by good Radio Parts Dealers in most cities. They are sold subject to our regular 30 day guarantee of "Satisfaction or your Money Back." Due to the scattered demand for condensers built for short wave work, the 5 and 7 plate sizes are not so widely stocked by dealers. Orders will be filled direct, or may be placed through your dealer and his jobber. If you prefer to order direct, use this coupon. Send no money. Just pay the postman the price plus a few cents postage.

FOR THE FIRST TIME—

**A transformer that really matches
the characteristics of the tube.**

CERTAINLY—A General Instrument Product

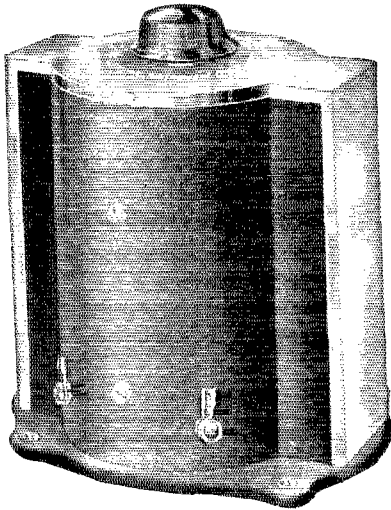

The G. I.
Variable Audio
Transformer

(Type 101)

Without a doubt the most important radio development since the industry became generally popular.

It is easily adjustable—merely turn the knob until reception is clearest and sharpest—the result is perfect co-ordination between transformer and tube; positive absence of any signs of squeals and howls; perfect reproduction.

Designed for use in any set—in the detector circuit, and any or all stages of amplification. Now for the first time can more than two stages of Audio Amplification easily be used by even a novice.

PRICE
\$10⁵⁰

At your dealers—otherwise send purchase price and you will be supplied postpaid.

General Instrument Corporation

Manufacturers of "Bureau of Standards" Variable Primary Condensers

477 Broadway

New York City

THE COMMUNICATIONS DEPARTMENT, A. R. R. L.

Manager	3DW	ATLANTIC DIVISION	E. B. Duvall	Box 317	Edmonston, Md.
A.D.M. D. of C.	3AB	A. B. Goodall	1824 Ingleside Ter.	Washington	Ten Hills, Baltimore
A.D.M. Maryland	3HG	G. L. Deichmann, Jr.	Chapel Gate Lane	Collingswood	Buffalo
A.D.M. So. N. J.	3EH	H. W. Deussman	149 Washington St.	Philadelphia	Wilkinsburg
A.D.M. West. N. Y.	3BJ	C. E. Nichols	698 Weston St.	Wilmington	
A.D.M. East. Pa.	3FM	J. P. Rau	1551 So. 58th St.		
A.D.M. West. Pa.	8ZD	P. E. Wiggin	714 Johnson St.		
A.D.M. Delaware	8AIS	H. H. Layton	805 Washington St.		
Manager	8ZZ	CENTRAL DIVISION	C. E. Darr	137 Hill Ave., Highland Pk.	Detroit, Mich.
A.D.M. Michigan	8ZH	F. D. Padala	321 First Ave.	738 Woodcock Ave.	Spring, Mich.
A.D.M. Ohio	8AA	W. E. Schweitzer,	4264 Hazel Ave.,	448 Newron Ave.	Vina
A.D.M. Illinois	9AAW	C. N. Crapo	310 N. Illinois St.	Glenkary Farm	Chicago
A.D.M. Wisconsin	9VD	D. J. Angus	54 N. Penn. Ave.		Milwaukee
A.D.M. Indiana	9CYQ	J. C. Anderson			Indianapolis
A.D.M. Kentucky	9EI				Lexington
Manager	9ZT-9XAX	DAKOTA DIVISION	D. C. Wallace		Minneapolis, Minn.
A.D.M. Minnesota	9EGU	C. L. Barker			Henning
A.D.M. So. Dak.	9EJS	M. J. Junkins			Ervant
A.D.M. No. Dak.	9EWN	George R. Moir	\$20 4th St.		N. Fargo
Manager	4MM	DELTA DIVISION	H. E. Printer	324 Hamilton Nat. Bank Bldg.	Chattanooga, Tenn.
A.D.M. Mississippi	5AKP	J. W. Gullett		819-29th Ave.	Meridian
A.D.M. Arkansas	5XAR	Pr. L. M. Hunter		207 1/2 Main St.	Little Rock
A.D.M. Tennessee	4KN	L. K. Rush		4 Second St.	Memis
A.D.M. Louisiana	5DK	C. A. Preitag		3520 Forsney St.	New Orleans
Manager	2RRB	HUDSON DIVISION	E. M. Glaser	845 E. 13th St.	Brooklyn, N. Y.
A.D.M. No. N. J.	2WR	A. G. Wester, Jr.	1075 Chancellor St.	1309 W. Farms Rd.	Irrington
A.D.M. N. Y. C.	2CWR	P. H. Marlon		175 Quail St.	Bronx
A.D.M. East. N. Y.	2PV	H. N. Ammenhueser			Albany
Manager	9DXY	MIDWEST DIVISION	P. H. Quirby	Box 134A, Rt. 9	Omaha, Nebr.
Asst. Sec. to D.M.	9RZ	C. B. Diehl	3006 S. 23d Ave.	116 Hyland Ave.	Omaha
A.D.M. Iowa	6ARZ	E. E. Watts	8020 Mercer St.	312 E. Rutledge St.	Ames
A.D.M. Missouri	9RR	L. B. Laizuro	312 E. Rutledge St.	4708 N. 39th St.	Kansas City
A.D.M. Kansas	9CCS	C. M. Lewis			Yates Center
A.D.M. Nebraska	9CJT	H. A. Nielson			Omaha
Manager	1AVVW	NEW ENGLAND DIVISION	T. P. Cushing	75 College St.	Springfield, Mass.
A.D.M. R. I.	1BVB	D. R. Paucher	86 Franklin St.	11 Staric St.	Westerly
A.D.M. N. H.	1GJ	C. E. Sawyer			Manchester
A.D.M. Vermont	1AJG	C. T. Keer			Foulnree
A.D.M. W. Mass.	1ASJ	C. V. Green			Worcester
A.D.M. E. Mass.	1KY	Miss Gladys Hannah			Cambridge
A.D.M. Conn.	1BM	H. E. Nichols			Bridgeport
A.D.M. Maine	1UU	S. B. Coleman			Bancor
Manager	7EK ex 7ABB	NORTHWESTERN DIVISION	Everett Kiek	3802 Hoyt Ave.	Everett, Wash.
A.D.M. Montana	7FD	A. R. Wilson			Ramsey
A.D.M. Wash.	7FD	Otto Johnson			Seattle
A.D.M. Oregon	7IT-XAF	Ashley C. Dixon, Jr.			Portland
A.D.M. Idaho	7OB	K. S. Norquest			Boise
A.D.M. Alaska	7DE	Leo H. Machin			Cordova
Mgr. Southern Section	6BTR	PACIFIC DIVISION	L. E. Smith	340 N. Painter Ave.,	Whittier, Calif.
A.D.M. Dist. 1, 2, 3	6CHZ	W. S. Wiggins			Whittier
A.D.M. Ariz.	6ANO	D. B. Lamb			Mass
Mgr. Northern Section	6GZ	P. W. Dunn			Oakland
A.D.M. Dist. 4	6NX	F. J. Quement			San Jose
A.D.M. Dist. 5	6BTP	George Hecker, Jr.			Oakland
A.D.M. Dist. 6	6BAF	St. Clair Adams			Bureka
A.D.M. Nevada	6UO	C. B. Newcomb			Yreka
Mgr. Hawaiian Section	6TO	K. A. Cautin			Honolulu, T. H.
A.D.M. Hawaii	6BCQ	W. H. Friedly			Honolulu, T. H.
Manager	3BZ	ROANOKE DIVISION	W. T. Gravelly	324 Main St., Box 245	Danville, Va.
A.D.M. West Va.	3BSU-AKZ	C. S. Hoffman, Jr.			Wheeling
A.D.M. Virginia	3CA	J. P. Wofford			Roanoke
A.D.M. No. Carolina	4JR	R. S. Morris			Gastonla
Manager	7ZO	ROCKY MOUNTAIN DIVISION	N. R. Hood	1922 S. Ash St.	Casper, Wyo.
A.D.M. Colorado	9CAA	C. R. Stedman			Denver
A.D.M. Utah	6ZT	Art Johnson			Salt Lake City
Manager	5AJP	SOUTHEASTERN DIVISION	A. D. Trum	217 Catoma St.	Montgomery, Ala.
A.D.M. S. C.	1RR	A. Dunre			Spartanburg
A.D.M. Alabama	5AX	H. S. Brownell			Birmingham
A.D.M. Florida	4GY	W. F. Grogan			Fl. Myers
A.D.M. Georgia	4HO	J. Morris			Atlanta
A.D.M. Porto Rico	4OI	Louis Rexach			San Juan
Manager	5ZC	WEST GULF DIVISION	P. M. Carlett	2515 Catherine St.	Dallas, Texas
A.D.M. Oklahoma	5APG	K. M. Phret			Oklahoma City
A.D.M. So. Texas	5VK	E. A. Sahn			New Braunfels
A.D.M. No. Texas	5AJT	W. B. Forrest, Jr.			Waxahatche
Manager	1DD	MARITIME DIVISION	W. C. Borrett	14 Sinclair St.	Dartmouth, N. S.
A.D.M. P. E. I.	1RZ	W. Hyndman			Charlottetown
A.D.M. N. B.	1EI	T. B. Lacey			St. John
Manager	9BJ	ONTARIO DIVISION	W. Y. Sloan	167 Close Ave.	Toronto Ont.
A.D.M. Cen. Ont.	3VH	A. R. Williams			Toronto
A.D.M. East. Ont.	3APP	P. A. C. Harrison			Ottawa
A.D.M. So. Ont.	3ZB	J. A. Fanev			St. Catharines
A.D.M. No. Ont.	3NT	Wm. Sutton			St. William
Manager	3BE	QUEBEC DIVISION	Alex Reid	202 Birch Ave.	St. Lambert, Que.
Manager	4GT	VANALTA DIVISION	A. H. Amussen	223 2nd Ave. N. E.	Calgary, Alberta
Manager	4DE	PRAIRIE DIVISION	F. E. Rutland	452 St. John Ave.	Winnipeg
A.D.M. Sask.	4CB-9BX	E. L. Marnard			Morse
A.D.M. Manitoba	4DE	F. E. Rutland, Jr.			Winnipeg

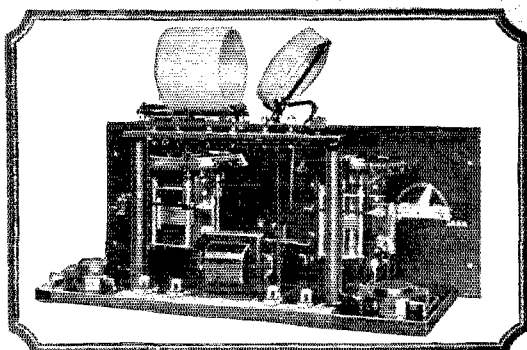

General view of interior of CR-18.

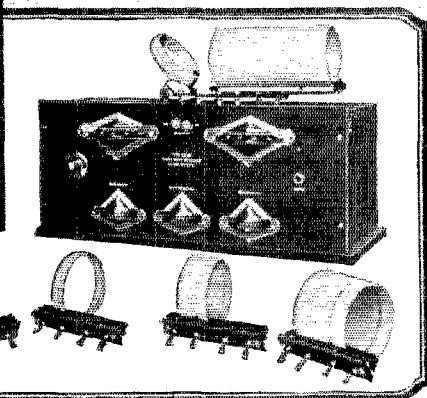

Front view of CR-18 with 200 meter coil intake and additional coil for 10, 20, 40 and 80 meter bands.

A "Blue-Blooded" Low-Wave Receiver

THE new Grebe CR-18 comes of a long line of blue-blooded ancestors. For years Grebe has been furthering the interests of the amateur in every way and building the best possible apparatus for their use.

In the CR-18 is offered an improved low-wave receiver. It uses a regenerative circuit of the capacity coupled type, so arranged that the body capacity effects are *nil*. The regeneration is smooth and not critical with wave length changes. There are six self-

supporting air dielectric coils, instantly interchangeable, that cover the wave length range from 10 to 200 meters. The CR-18 consists of a detector and one stage of audio, utilizing 201-A Tubes, with Grebe S-L-F Condensers and Grebe tangent wheel verniers.

Write for full description.

A. H. Grebe & Co., Inc., 109 West 57th Street, New York
 Factory: Richmond Hill, N. Y.
 Western Branch: 443 So. San Pedro St., Los Angeles, Cal.



It is written:

"A perfect vase never came from a bad potter's wheel."

When one realizes its origin, the superior reception of the CR-18 is not to be wondered at.

Doctor H. H.

THE GREBE CR-18

This Company owns and operates stations WAHG and WBOQ; low wave rebroadcasting stations, mobile WGMU and marine WRMU, and stations 2ZV and 2XE.



All Grebe apparatus is covered by patents granted and pending.

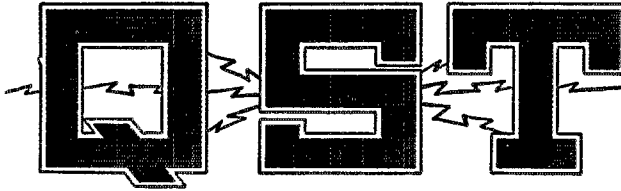

The Official Organ of the A.R.R.L.

VOLUME X

MAY 1926

NUMBER 5

Editorials	7
Come to the Hudson Division Convention	8
Taming the Synchronous Rectifier	<i>Robert S. Kruse</i> 9
Atlantic Division Convention	16
Breaking Into Amateur Transmission Part II	<i>John M. Clayton</i> 17
Simplifying Operating	21
A. R. R. L. Information Service Rules	22
A Reflexed Receiver with Resistance Audio Coupling	<i>L. W. Hatry</i> 23
Picking a Good Antenna for the Short-Wave Station	<i>C. H. Starr</i> 27
Medals for Conspicuous Radio Service	29
A Dry Electrolytic Rectifier	<i>Robert S. Kruse</i> 30
Book Reviews	32
Byrd Arctic Expedition Sails	32
New Tubes	38
New Condensers	34
PRR	35
A Low-Power Transmitter Kit	37
Progress of the Wilkins Expedition	38
How to Check Radio Messages	39
A New S. F. L. Condenser	41
1KM Schedules	41
Grasshopper Radio	<i>M. Adaire Garmhausen</i> 42
Adjusting the Crystal-Controlled Transmitter	<i>Stanley P. McMinn</i> 43
Transmitting Tube Reactivation	45
Antenna-Counterpoise Fundamentals	46
Experimenters' Section Report	47
Central Division Michigan State Convention	49
A Vacation Possibility	50
Amateur Radio Stations 2CXL-2XBB	51
Official Wavelength System	53
I. A. R. U. News	54
Calls Heard	57
Statement of Ownership	59
Correspondence	60
HAM-ADS	88
QST's Index of Advertisers	94

Official organ of the A.R.R.L. and the International Amateur Radio Union
QST is published monthly by The American Radio Relay League, Inc., at Hartford, Conn., U. S. A.

Kenneth B. Warner (Secretary, A.R.R.L.),
Editor-in-Chief and Business Manager

F. Cheyney Beekley
Managing Editor and Advertising Manager

Robert S. Kruse,
Technical Editor

John M. Clayton,
Assistant Technical Editor

David H. Houghton,
Circulation Manager

Subscription rate in United States and Possessions, Canada, and all countries in the American Postal Union, \$2.00 per year, postpaid. Single copies, 25 cents. Foreign countries not in American Postal Union, \$2.50 per year, postpaid. Remittances should be by international postal or express money order or bank draft negotiable in the U. S. and for an equivalent amount in U. S. funds.

Entered as second-class matter May 29, 1919, at the post office at Hartford, Connecticut, under the act of March 3, 1879. Acceptance for mailing at special rate of postage provided for in section 1103, Act of October 3, 1917, authorized September 8, 1922. Additional entry as second-class matter, acceptable at special rate of postage provided for above, at Springfield, Mass., authorized September 17, 1924.

Copyright 1925 by the American Radio Relay League, Inc., Title registered at United States Patent Office.
Member of the Radio Magazine Publishers' Association.

THE AMERICAN RADIO RELAY LEAGUE

The American Radio Relay League, Inc., is a non-commercial association of radio amateurs, bonded for the promotion of interest in amateur radio communication and experimentation, for the relaying of messages by radio, for the advancement of the radio art and of the public welfare, for the representation of the radio amateur in legislative matters, and for the maintenance of fraternalism and a high standard of conduct.

It is an incorporated association without capital stock, chartered under the laws of Connecticut. Its affairs are governed by a Board of Directors, elected every two years by the general membership. The officers are elected or appointed by the Directors. The League is non-commercial and no one commercially engaged in the manufacture, sale or rental of radio apparatus is eligible to membership on its Board.

"Of, by and for the amateur", it numbers within its ranks practically every worth-while amateur in the world and has a history of glorious achievement as the standard-bearer in amateur affairs.

Inquiries regarding membership are solicited. A bona fide interest in amateur radio is the only essential qualification; ownership of a transmitting station and knowledge of the code are not prerequisites. Correspondence should be addressed to the Secretary.

OFFICERS

<i>President</i> HIRAM PERCY MAXIM Hartford, Conn.	<i>Communications Manager</i> F. E. HANDY Hartford, Conn.	<i>Treasurer</i> A. A. HEBERT Hartford, Conn.
<i>Vice-President</i> CHAS. H. STEWART St. David's, Pa.		<i>Secretary</i> K. B. WARNER Hartford, Conn.

DIRECTORS

<i>President</i> HIRAM PERCY MAXIM Drawer 4, Hartford, Conn.	<i>Dakota Division</i> C. M. JANSKY, JR. Dept. of Elec. Eng., U. of M., Minneapolis, Minn.	<i>Pacific Division</i> ALLEN H. BABCOCK 65 Market St., San Francisco
<i>Vice-President</i> CHAS. H. STEWART St. David's Pa.	<i>Delta Division</i> BENJ. F. PAINTER 424 Hamilton Nat'l Bank Bldg., Chattanooga, Tenn.	<i>Roanoke Division</i> W. TREDWAY GRAVELY 503 Main St., Danville, Va.
<i>Canadian General Manager</i> A. H. E. RUSSELL 6 Mail Bldg., Toronto, Ont.	<i>Hudson Division</i> DR. LAWRENCE J. DUNN 480 East 19th St., Brooklyn, N. Y.	<i>Rocky Mountain Division</i> PAUL M. SEGAL c/o District Attorney, West Side Court Bldg., Denver, Colo.
<i>Atlantic Division</i> DR. EUGENE C. WOODRUFF 234 W. Fairmount Ave., State College, Pa.	<i>Midwest Division</i> PORTER H. QUINBY Box 134A, Route 6, Omaha, Neb.	<i>Southeastern Division</i> HARRY F. DOBBS c/o Dobbs & Wey Co., Atlanta, Ga.
<i>Central Division</i> CLYDE E. DARR 187 Hill Ave., Highland Park, Detroit, Mich.	<i>New England Division</i> DR. ELLIOTT A. WHITE Dartmouth College Hanover, N. H.	<i>West Gulf Division</i> FRANK M. CORLETT 2515 Catherine St., Dallas, Tex.
	<i>Northwestern Division</i> K. W. WEINGARTEN 3219 No. 24th St., Tacoma, Wash.	

Address General Correspondence to Executive Headquarters, Hartford, Conn

EDITORIALS

The Lust for DX

DX IS all right. To desire to work the ends of the earth is a laudable ambition. We know, because we ourselves went thru it. To be the first to work a new country is to enjoy a terrific new "kick." We know that too, for we had the honor of being the first to click with a couple of countries. And to have a transmitter so good that one doesn't have to content oneself with modest ranges but can go after the most distant station that can be heard is no more than the normal desire of every normal amateur.

But when this craving for DX reaches the proportions of an obsession, when it blinds its possessor to the realization that there are other forms of amateur activity, it is just as bad as any other form of intemperance. Amateur Radio is suffering to-day because the hunger for super-distance contact has become a lust which has almost killed short-range, friendly, casual contacts. This business of friendly contacts with one's own radio neighbors is really the most important thing in the game. It was what built up the wonderful spirit of the amateur body; it was this camaraderie of the air which cemented all Amateur Radio in the splendid solidarity which our "old-timers" remember with a sigh. To-day it is precious near gone. We have sounded the warning before. If we don't look sharply now, the most potent thing in the amateur fellowship will be beyond our recall.

The old-timers "wonder what's the matter." We've been wondering too, and we believe that this is it. Is the gentle art of brasspounding a more bloodless and a less human and enjoyable matter than it used to be? If so, let us remember that we make the game ourselves, and that we have it in our power to make it anything we wish. Does *QST* sometimes seem a cold and fishy product by comparison with the warm human document that we have in mind as our ideal. *QST* is not so much a shaper of our destinies as it is a mirror that reflects our monthly status. *QST* wants to be the lively human chronicle of the warm fellowship of radio amateurs, and so long as that fellowship exists it can and will be such. But we are not given to forced sentiment

here and that fellowship must live before it can be reflected in our pages.

The moral in this for the operating amateur is simple: be more human; learn to talk; use your station as an instrument for the cultivation of friendships; give heed to the spirit of Amateur Radio and learn that there is something in the game far more precious than the eternal hollering for QSL cards.

Democracy

A CONSTITUTION and a set of by-laws admittedly are a dreary batch of reading. Perhaps that is why the majority of A. R. R. L. members seem to be uniformed on the constitutional form of government of our League.

We are a democracy. By that we mean that every member has an equal voice in determining our affairs. Let us run over the scheme again briefly. Our operating territory is divided into fourteen divisions. The thirteen divisions in the United States each elect a representative called a Director, and the Canadian members elect a Canadian general manager who is also a Director. These Directors get together at least once a year. They elect the president and the vice-president, who then become Directors too. They appoint the secretary, the treasurer, the communications manager. These sixteen Directors are the absolute bosses of A. R. R. L.—Headquarters aren't! They hire and fire at their pleasure, and they are responsible for everything that happens. Anything can be done in A. R. R. L. management that the Board of Directors wants, but nothing can be done that the Board doesn't want.

Every action of a Board can't suit everybody, and we ought to think for a moment on the duty of the minority whose views sometimes aren't met. When the United States government holds an election, say for President, everybody gets steamed up and we work as hard as possible for the thing we want. Then the country wakes up some morning and finds that one of the candidates is elected. What happens? Everybody accepts him, he becomes "our President" whether we liked him before he was elected or not, because in this country we run things on the principle of majority

rule and the greatest good for the greatest number. Not so with some of the smaller republics to the south of us. When they wake up down there and find that things haven't gone to their liking, they promptly start another revolution. But we don't do things that way in this country, and the same thing is true of our A. R. R. L. We manage our affairs on the basis of the greatest good to the greatest number. Every member having participated in the selection

of the Directors who make our determinations, it is patently the duty of those whose views sometimes aren't met to accept the decisions in the same manner as U. S. citizens accept the President of the Republic—majority rules. Incidentally this emphasizes how vital it is for the membership to continue in office Directors of the high calibre of our present Board.

—K. B. W.

Come to the Hudson Division Convention

ON MAY 13th, 14th and 15th there will be held in New York City a real amateur convention—the convention of the A. R. R. L. Hudson Division. It will differ in many ways from all previous amateur conventions. Every effort is being made to make it a dignified high-grade affair worthy of the traditions of the League and a meeting of such value to the amateur that it will be worth the while of every member within reach to come to New York for the three days.

In the first place this is truly a convention of A. R. R. L. members and their friends, and will not be open to the public. There will not be a "show" in the ordinary sense of that word. The meeting will not be a commercial one, its intent will not be to make money, and the price of admission will be very small. It will be strictly of, by and for the two-way transmitter and the experimenter.

Selected manufacturers have been invited to make instructive and educational displays of their products in free space provided for their use, and a series of exhibits and demonstrations of prime interest to the amateur is assured. Amongst the various convention meetings scheduled for the discussion of various matters of interest to the members, perhaps the most important is the technical sessions. Rather than a haphazard system of talks, the technical meetings at this convention will be laid out in two carefully-planned courses, each to consist of six hours of lectures spread over the three days and covering a considered plan. The technical staff of QST is collaborating in the planning of these talks, and it is expected that some of our staff will deliver some of the lectures. The various talks will be related so as to cover all recent developments in modern amateur practice. The "A" course, for the transmitting amateur, will deal with short-wave transmitting, reception, League traffic practices, etc. The "B" course will be introductory to the amateur transmitting game, and will be the best possible answer that can be devised to

meet the earnest desire of many new-comers in radio to "break into Hamdom." Although registration in these courses will be open only to members of the League, QST readers who are not members will please note that a convenient opportunity will be given them to become members. (Or see the handy application blank in the rear of this issue.)

Interesting contests designed to test the amateur's all-around radio knowledge will be held, with valuable prizes for the winners. There will be a big A.R.R.L. banquet, on A. R. R. L. levels, on the last night, at the Hotel Majestic, 72 nd St. and Central Park West. The general meetings will be held at the Engineering Societies Building, 29 West 29th St.

The Honorary Committee of Sponsors for this convention consists of Hiram Percy Maxim, president, A. R. R. L., Chairman; Hon. Herbert Hoover, Secretary of Commerce; Hon. Curtis D. Wilbur, Secretary of the Navy; Senatore G. Marconi; Mr. Donald McNicol, president, Institute of Radio Engineers; Major General C. McK. Saltzman, Chief Signal Officer of the Army; Capt. Ridley McLean, U. S. N., Director of Naval Communications; Col. E. T. Hartmann, Second Corps Area Signal Officer; Capt. Tom C. Rives, Liaison Agent of the Army-Amateur System; Capt. John Autrey, Asst. Second Corps Area Signal Officer. We have backing men!

For something new under the sun, for a real amateur convention planned and managed in keeping with the standards of A. R. R. L., come to New York May 13th to 15th. For further information see the announcement on the third cover of this number of QST, or address the Hudson Division Convention Committee, 480 E. 19th St., Brooklyn. CU tr, OM!

—K. B. W.

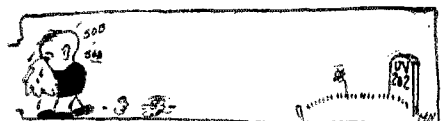

Taming the Synchronous Rectifier

By Robert S. Kruse, Technical Editor

Q ST has been the target for questions and kicks because so little discussion has been given concerning the synchronous rectifier for plate supply.

There has been a good reason for the silence. Until a year ago we didn't know how to make a "sink" operate so that it would not be a nuisance to the neighborhood. Since that time several schemes have been worked up.

About two years ago we began to be interested in the possibilities of the "sink".

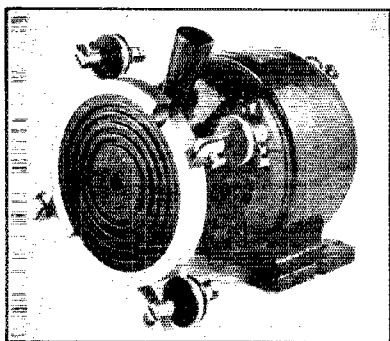

Advance rotary synchronous rectifier lent to QST for test. Made by Advance Electric Co. of Los Angeles. The brush rig is clamped by turning the handle and can then be shifted while the set is running. The wheel is of bakelite with the segments securely moulded in.

Every time that a "perfect synchronous rectifier" was heard of, the story was followed down. First would come reports that at 1500 miles the signal was very good and the tone not bad at all. Then when one followed the signal at a nearer range the amateurs 50 miles away would comment unpleasantly on the "hash" that went with the signal. Finally we would ask the neighbors and get opinions that scorched paper—especially if they came from the owner of a superheterodyne. Somehow, superheterodynes seem especially wide open to interference from power-leaks and the like.

The Difficulty.

The difficulty seemed to be in all of these cases that the "hash" made much more noise than the carrier wave—especially locally. If it happened to be a vibrating "sink," this meant sparking at the contacts and if it was a rotary (motor-driven) "sink" the difficulty was in sparking at the brushes. Al-

ways the difficulty was from the sparks at the contacts, and exceedingly little sparking seemed perfectly able to raise a tremendous fuss. That isn't surprising when one remembers what a row is caused by a loose 40-watt lamp anywhere in the house.

The Advantages.

This was discouraging but it seemed worth while to keep following the thing up because the "sink" rectifier has some very nice advantages. For one thing the transformer that feeds it does not need to have a center tap, for another there is almost no voltage drop thru the rectifier which means good efficiency and also removes the tiresome "yoop yoop" effect at the receiving end—the thing that is politely called "tilting." Besides that (if the thing can be made to operate sparklessly) there is no upkeep for a long time.

It looks then as if one needs only to stop the sparking to have a really good rectifier.

The Equipment.

Before starting to explain the cures it is a good idea to explain the general theory of the synchronous rectifier. First comes the vibrating rectifier. A simple form of this is used for battery charging. There are several makes such as the Valley, Hom-charger, FF battery booster etc. These are not exactly alike but the general idea can be explained by a look at Fig 1. Here the steel armature A is mounted on the end of the U magnet and therefore is magnetized.

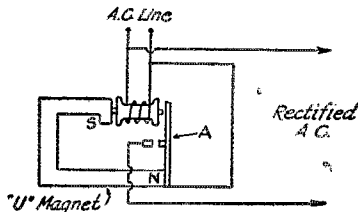

FIG. 1

A VIBRATING SYNCHRONOUS RECTIFIER
A, Armature magnetized by magnet on which it is mounted.

S and N, poles of the magnet.
If the output is wanted at some other voltage than 110 it is not supplied from the line directly, but from a transformer as shown in Fig. 10.

It is attracted by the other pole of the U magnet which extends thru the magnet spool to a point close to the armature. The pull is not quite large enough to bend the armature over so as to close the contacts. If a

current is run thru the magnet winding the pull increases and the contacts close. If the current thru the magnet spool is reversed the pull becomes less and the contacts open. If an *alternating* current is put thru the spool the contacts will close during one half of the cycle and open during the other half of the cycle. To get smooth operation the

depends on the correct design of the vibrator and contacts.

Rotary Rectifiers.

The rotary rectifiers are all motor-driven, the motor being synchronous, that is it operates at exactly 1200, 1800 or 3600 revolutions per minute if run on 60-cycle supply and at exactly 1000, 1500 or 3000 R. P. M. if operated on a 50-cycle supply. Suppose we consider a simple rectifier of this sort running at 1800 R. P. M. on a 60-cycle supply. The wheel looks like the one shown in Fig. 2. The central part is of insulating material (usually bakelite-dilecto) and the segments on the edge are of brass or copper. The wheel is turning to the left. In Fig. 2A the transformer voltage has just reversed so that the upper end of the winding is positive. The current then goes thru the brushes as shown by the short arrows. Now the motor is running at 1800 R. P. M., which means that the wheel turns around once each 1/30 of a second. In 1/120 of a second it will make 1/4 of a turn and get into the position shown in Fig 2B. Now the transformer voltage is 60 cycle, in other words it reverses 120 times per second. Therefore by the time that the wheel has turned to the position B, the transformer will have reversed and the current flow will be as shown

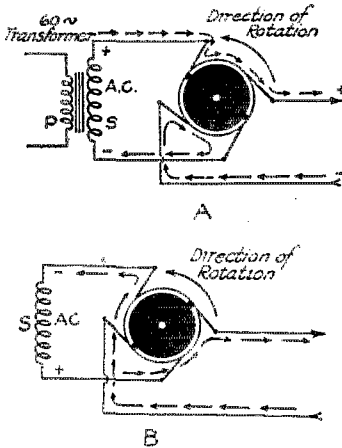
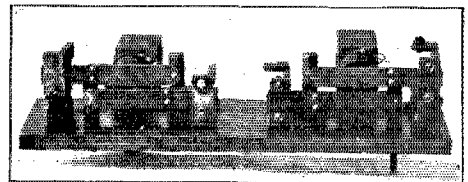

FIG 2

OPERATION OF ROTARY SYNCHRONOUS RECTIFIER

A—Wheel in 1st position.
 B—Wheel has made 1/4 turn and reversed connections but transformer has also reversed, therefore output remains in same direction. If the supply is 60 cycle then B is 1/120 of a second after A.

armature must be of the proper size and stiffness, also the contacts must be adjusted carefully. Usually one of these contacts is made of carbon and the other of copper or silver to prevent sticking. One of our photographs shows two such units from



Full-wave vibrating rectifier used by Leland Thompson at 9BRI with the circuit shown in Figure 10B. Note that the vibrators are not polarized as suggested by Fig. 1 but are simply mounted in front of the magnet and depend on the changes in total magnetic pull to operate them. Could a simpler rig be imagined?

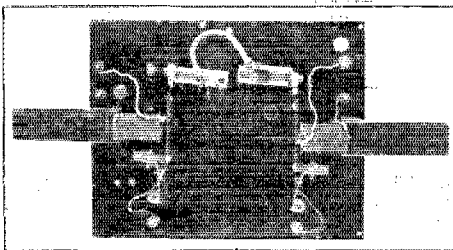

Half-wave rectifier of the vibrating type. Lent to QST for test. Made by Leland Thompson, of 9BRI and used in the circuit of Fig. 10A.

"Valley" chargers, mounted on a base for operation in series at higher voltages than a single unit will handle.

In a rectifier of this sort everything

by the little arrows in 2B. Again the upper right wire is the positive one.

This keeps up with the result that with A, C being fed into two brushes pulsating D, C comes out of two others. There are several other ways of building the wheel but the general idea remains the same.

The Cause of the Sparking.

The general cause of all sparking (either vibrator or disc) is the same—voltage across the contacts or brushes when they are opening or closing. When no filter is being used there will be sparking except when the contacts open *and* close, i. e. while there is zero voltage at the transformer secondary. Now it is perfectly possible to do *one* of these things at zero voltage but one cannot do both of them at the same time, so there

will inevitably be light sparking at either the "make" or the "break." If the voltage is not too high the airgap in the wheel can be made small to cut down the time between "break" and "make", or else one can use a special wheel such as used by Marlo and others, to get a long "ap" while still using a short time of "break."

The Filter.

Because it is possible to get reasonably little sparking when using no filter a great many synchronous rectifiers are being run without a filter. It is certainly a poor practice. For three years I have been combing the tuner for "sink tones" and I have yet to hear the first unfiltered synchronous recti-

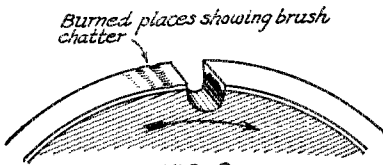

FIG. 3

EFFECT OF A CHATTERING BRUSH

fier that produces anything one can properly call a tone—every one that I have heard has merely made a noise. Often it has been a very loud noise—but always a noise.

As soon as one starts to use a filter many things happen at the contacts or brushes. If there is a condenser next to the wheel there are violent blue sparks of a leading nature i.e. they jump to meet the approaching segment or armature. This is because at the moment of "make" the transformer voltage is not yet equal to the voltage still left in the filter from the last half-cycle.

If there is an inductance next to the wheel there will be a beautiful flaming arc lagging after the break i. e. it follows the segment or armature as the break is being made.

All of these things can be made less

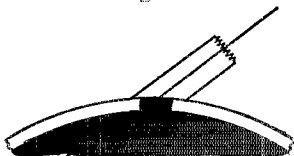

FIG. 4 BALLANTINE TRIPLE BRUSH

BALLANTINE'S TRIPLE BRUSH FOR DECREASING SPARKING

troublesome by making the filter smaller but as long as there is any sparking there is bound to be hash which may not bother oscillating receivers but which plays havoc with the unlucky superheterodynes and neutrodyne nearby.

Airgaps in the Wheel.

To prevent burning the insulation at the

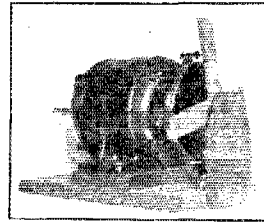

Extremely simple rectifier used by Robert Morris of 2CQZ in connection with the circuit of Fig. 6. Not a single bit of machine work is necessary—even the wheel can be trued by using the motor itself as a lathe.

end of segments some rotating rectifiers (see photos) are made with airgaps. This stops the burning of the insulation but unfortunately compels the brush to jump the gap and then climb on the next segment. Since the thing happens at high speed the wheel will usually show "stutter marks" where the brush has chattered after hitting the next segment. This is shown in Fig 3. If anything of that sort shows on the wheel

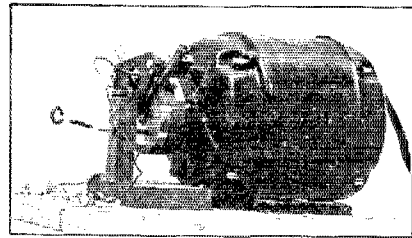

Rotary rectifier for voltages up to 1500. Made by A. B. Goodall and used at 3AB. The small diameter of the wheel permits the use of a smaller motor. The construction is similar to the Marlo wheel but without the bakelite ridge. The segments extend down the side of the wheel, permitting the use of a brush on each side of the wheel and only two on the edge of the wheel.

it is absolute proof that some of the troublesome "hash" is being manufactured. The way to tell is to take a short-wave tuner into another part of the house and listen without a receiving antenna. If there is fuzz on the tone things are not right. The note should be as clean as that of a kenotron or a good electrolytic.

Gauze Brushes.

Rotating rectifiers with gaps or uneven places in the wheel cannot use carbon brushes or laminated copper brushes very well. They usually employ woven wire brushes, simply a short length of "Belden Braid" as wide as the wheel. In using such brushes it is important to keep the brush trimmed.

Sparkless Filters.

When one is all thru talking about types

of wheels and vibrators the fact remains that it is not possible to "make" and "break" when the filter and transformer voltages are the same. There is certain to be a dif-

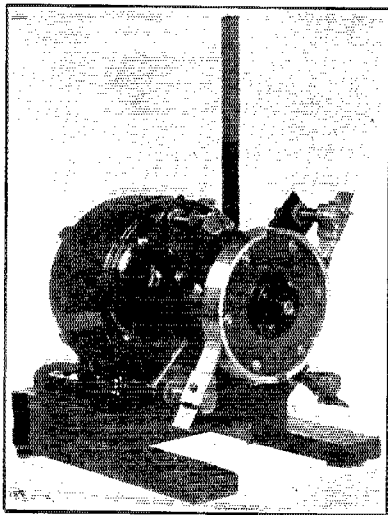

Stahl rotary rectifier. Made by Stahl Rectifier Co. of Chicago. In this wheel the gaps are filled with compressed mica which resists injury from flash-overs. With proper filter circuits to prevent sparking this is an excellent type of wheel as the brushes have a smooth path.

ference in voltages at the "make" or the "break" and generally both. If there is a difference of voltage there will be sparking unless some sort of an electrical shock absorber is provided in the front part of the filter—that is the part next to the wheel.

Stuart Ballantine, in his well-known book, has suggested the shock absorber shown in Fig. 4 in which three brushes are used in each holder, the two side brushes being connected to the center thru resistances of about 5,000 ohms. This certainly reduces the sparking but the extra 8 brushes (considering the whole rig) put a great drag on the motor and tend to make it get out of

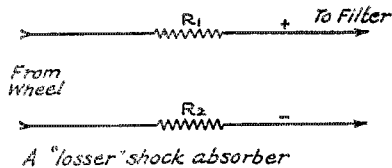

synchronism. If the extra brushes are of copper gauze and "set light" the scheme is a very good one to use with one of the other plans shown later.

I am not able to find the reference now, but some time ago there was shown in both *Radio* and *QST* a very simple shock-absorber made as shown in Fig. 5. R1 and R2 together must have about the same resistance as the plate circuit of the tube. This naturally means that about half the power is wasted in these resistances and (what is worse) the voltage regulation is poor.

A Better Method.

The first real successful method of spark prevention that I know of was devised by Robert Morris of 2CQZ. The scheme used is beautifully simple—after someone has shown us the way.

As I have said—it is always possible to shift brushes so that there will be no sparking to "break"—but we will immediately get sparking at the "make." The sparking at the "make" is caused by the filter charge attempting to "back out into the wheel" (or the vibrator) before the transformer voltage has risen high enough. Now if we had a way of stopping this "backfire" all would be well. It seems hard to believe that this should have been overlooked so long but seemingly Morris used the scheme for two years before anyone else thought of it. The arrangement is shown in Fig. 6. The "S" tube (or kenotron) does not need to stand

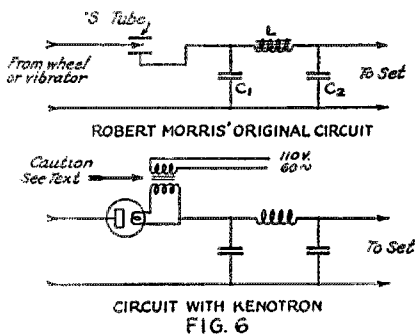

SPARKLESS FILTER CIRCUITS DEvised BY ROBERT MORRIS OF 2CQZ AT NEW YORK CITY

anything like the full voltage—only the "difference voltage" between the filter condenser C1 and the transformer at the moment of "make." Even at high voltages a single "S" tube is perfectly satisfactory. At lower voltages a small kenotron can be used—such as a sending tube that does not oscillate very well any more. The filament transformer of the kenotron must of course have plenty of insulation between the primary and secondary because the full plate voltage is attempting to break thru. This arrangement, with the air-gap wheel shown in the photograph, has run for many months in ordinary amateur communication and has

operated with no trouble and with beautiful freedom from the usual difficulties. It is possible to use a perfectly "full grown" filter

of Kenotron or "S" tube. The diagram is shown in Fig. 7. Both the diagram and the working drawings are shown thru the courtesy of J. T. Hood of 9BVZ, The Indianapolis Radio Club and Mr. D. J. Angus, of the Angus-Esterline Co.

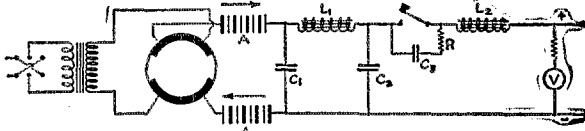

FIG. 7 INDIANAPOLIS CIRCUIT

- A—A—4 jars of electrolytic rectifier in each case.
- C1 Usual input condenser—2' microfarads or more.
- L1 Usual choke—25 to 100 henrys.
- L2 Key-thump inductance 2 henrys more.
- C3 Key-thump condenser, 1 microfarad.
- R Key-thump resistance, 100 ohms.
- L2 Key-thump inductance, 2 henrys.

Cautions—The voltmeter is a safe device. A filter fully loaded is a dangerous thing and holds a charge for a long—long time unless there is a leak to discharge it. At 10A a violent shock can be felt 20 minutes after the filter is charged.

The key used should be electrically operated to prevent shocks to the operator.

and to obtain a supply as nearly pure C. W. and steady current as is desirable—and more so.

Regulation.

Just at this point it is well to call attention to the fact that the size of the condenser C1 is the thing that determines regulation to a large degree. If it is made small or left off the output voltage will depend on the load entirely too much.

Another Valve Method.

In the neighborhood of Indianapolis another

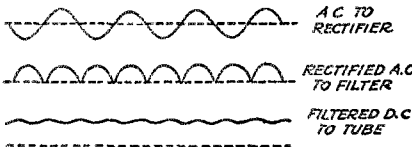
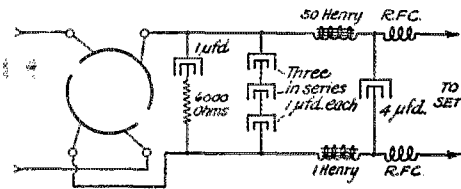

Dotted lines are zero lines

Fig 8—SPARKLESS FILTER CIRCUIT USED BY CHAUNCY HOOVER

Usually better spark prevention is obtained by omitting the 3-in-series condenser arrangement, using only the final condenser and the condenser in series with the resistance.

Originally shown on Page 36, of February QST, valve scheme is used for spark prevention. It seems to have been worked out independently and uses an electrolytic valve instead

but the performance was beautiful especially in view of the great simplicity of the method. With a Marlo wheel operating under a 750-watt load at 3000 volts there

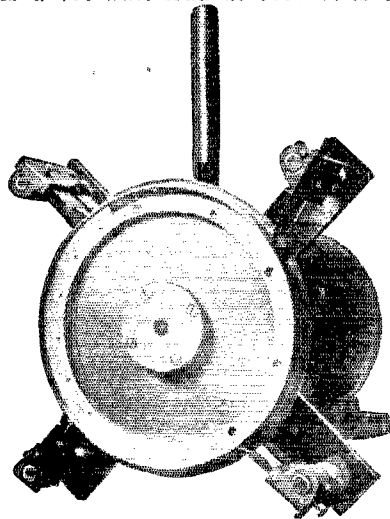

The well-known Marlo rectifier. One of these was lent to QST for test by the Marlo Electric Co of St. Louis. The segments are placed on opposite sides of a continuous insulating ridge. It is therefore possible to provide a smooth brush path, to use segments almost half-a-circle in length and to be sure that there will be no flashing between segments. Copper leaf brushes are used, giving a smooth contact.

was a 1/2" distance thru which the brushes could be moved with no sparking at all. The note in a nearby receiver was as beautiful as one could imagine. The circuit is shown again as Fig. 8.

Compensators for Starting Motors.

Many of the motors used to drive synchronous wheels take a heavy starting current,

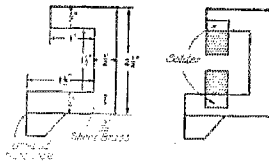
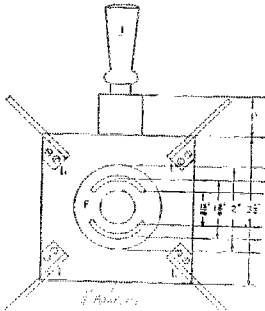
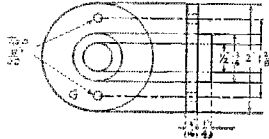
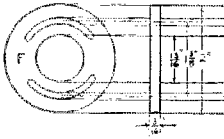
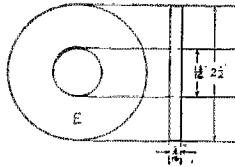
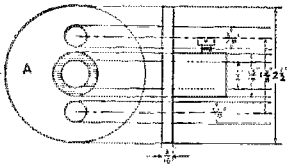
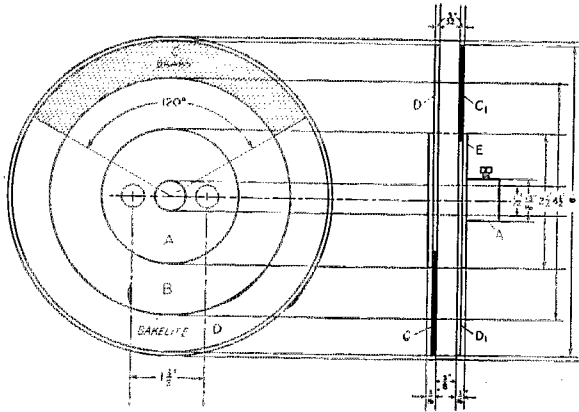

WORKING DRAWINGS FOR THE INDIANAPOLIS WHEEL, AND BRUSH RIGGING

This plan is the same as that of the Mario Wheel except that the segments are on the side of the wheel rather than the edge. The segments shown are each only 1/3 of a circle because of the type of brushes used. Note that the Mario wheel with laminated brushes uses almost a half circle, thereby decreasing the difference-voltage. This wheel can be changed in the same way by the use of other brushes.

blowing fuses or at least blinking lights. A simple way to get around this is to use a "compensator" as shown in Fig. 9. The connection at A is simply an auto transformer, with the whole thing connected

across the line and a tap at 1/3 or 1/2 voltage for the "start" point of the switch. Such a transformer can be made or an ordinary transformer can be used, the secondary being left open or else connected in series with the primary to provide a tap at the right place.

In Fig. 9 is suggested a scheme used at 10A to make the same transformer supply both the plate circuit and the reduced voltage for motor-starting. After the motor had started the primary was left on the line, feeding the filter. The keying was done as shown in Fig. 8.

If the compensator is small and heats when left on the line the switching scheme shown at 9C can be used. In all of these plans the reduced voltage had better not be more than 1/2 the usual line voltage. A quick-throw switch will help to reduce the surge when the motor is thrown to the "run" connection.

Vibrating Rectifiers.

Quite a while ago the France Mfg. Co. of Cleveland, Ohio, lent us several high-voltage vibrating rectifiers. These operated at 600 volts and half an ampere. The writer attempted to use them for plate supply and made a flat failure of it. With the Morris, Indianapolis or Hoover circuits they would most certainly have worked.

Since that time, thru the courtesy of the Valley Electric Co. of St. Louis, Leland E. Thompson, of Winner S. D. has used "Valley" vibrators to make up several successful vibrating rectifiers, one of which he was kind enough to lend me for an extended test. The operation was surprisingly smooth—until filtration was attempted. Then the usual difficulties began—sticking and violent explosions at the contacts, etc. This time though, the cure was in sight and it was found that very nice results could be obtained by using the Hoover circuit without

the 1/3 microfarad condenser—in other words an ordinary filter with a resistance of 6000 ohms in series with the first condenser. At 9BRI Mr. Thompson has operated this sort of rectifier satisfactorily at 2000 volts,

using half-wave rectification as shown in Fig. 10A. Here the two contacts are in series and with care in adjustment they break nearly enough at the same time to share the load very well indeed.

In Fig. 10B is shown a full-wave system. Here the plate voltage cannot be run above

vantage in using a R. F. choke in each of the output leads of a "sink". I have not been able to check this; the performance at 10A has always been just as good without these—provided that we used a proper spark preventing filter and put R. F. chokes in the usual place—that is at the output end of the filter. It is entirely possible though that if there is any sparking the first filter condenser will be less likely to burn out if R. F. chokes are used ahead of it. However the real cure for that is to stop the sparking.

The Reversing Switch

No rotary "sink" starts right-end-to more than half the time. The other half of the time the output must be reversed, either by a hand switch or by means of a polarized relay. The relay is rather lubberly but one can build such a thing easily enough. If a hand switch is used it should be boxed up with only the handle left out—or put behind a panel. A high voltage transformer is a dangerous thing—but a high voltage

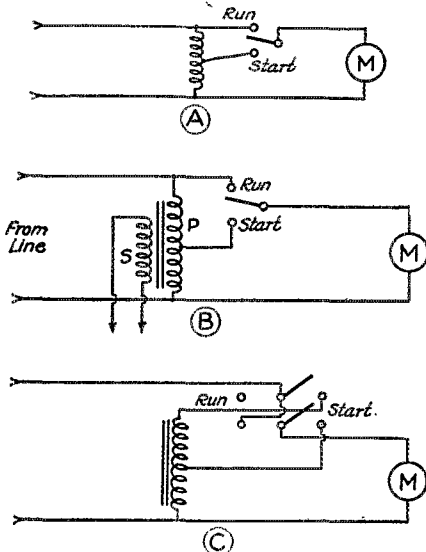

FIG. 9
MOTOR-STARTING COMPENSATORS

- A—Simple compensator.
- B—Plate supply transformer primary used as a compensator.
- C—Compensator with two-blade switch to take it off line when motor has started. This permits smaller windings as the service is intermittent.

the safe-voltage-per-contact unless two contact are used on *each half* of the cycle—in other words the system calls for twice as many vibrators for a given voltage.

R. F. Chokes

In some cases there is said to be an ad-

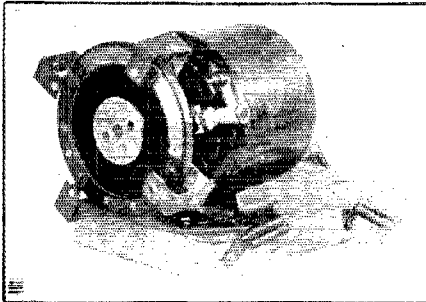

The Indianapolis rectifier mounted for spring suspension. The screws that pass thru the disc do no harm—the brushes directly opposite each other are connected together anyway.

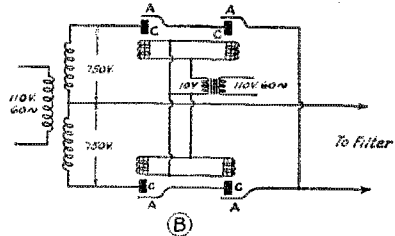
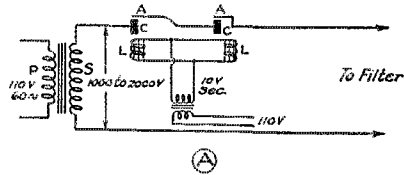

FIG. 10

VIBRATING RECTIFIER CIRCUITS USED BY LELAND THOMPSON

- A—Half-wave rectifier for output voltages up to 2000.
 - B—Full-wave rectifier for voltages to 750 or 1000.
- Note the difference in the connections of the magnet windings. For the sake of clearness the U magnets are not shown but it is to be understood that each vibrator A is mounted on one end of a U magnet, the other end of which carries the iron-cored spool L as shown in Fig. 1. In both diagrams the armatures (vibrators) A carry silver contacts which meet the carbon contacts C. For the sake of clearness the U shaped magnets which carry the iron cored spools are not shown. See Fig. 1 and Photos for construction.

transformer plus a big filter is even more deadly, therefore *don't touch the switch!*

Conclusion

This isn't supposed to settle the matter at all. Undoubtedly both the rotary and vibrating types will bear improvement. This magazine will be very glad to hear of improvements. Improvements should be as good as the types shown here,—with the suggestions referred to in this article in mind.

Acknowledgment.

Thanks are due to the various men devising the circuits spoken of, especially to Mr. Morris who ran a variety of tests at my request. For the loan of apparatus for tests I am indebted to The Marlo Electric Co. of St. Louis, The Advance Electric Co. of Los Angeles, Mr. Leland Thompson, referred to above, the Tobe C. Deutschmann Co. of Boston, Mr. Atwood Collins Page of 1BBQ at Hartford and John Clayton, Assistant Technical Editor of *QST*. Some of the tests were made by Arthur Zaverella, operator at IOA and formerly of 1BBE.

Atlantic Division Convention At Buffalo, June 24, 25, 26

BUFFALO and Western New York amateurs are enthusiastic over the First Annual Convention of the Atlantic Division, scheduled for the last three days of the week of June 21st under the auspices of the Radio Association of Western New York, of which Ernest H. Roy, 8RV, is President.

Hotel Lafayette, chosen as the scene of the convention, is one of Buffalo's finest and most centrally located hostelrys. It has its own convention hall, in which sessions will be held, and houses the remote control studio of broadcasting station WMAK.

The Program Committee in charge of Robt A. Trago, 8BSF, is working hard on a program which will include short, snappy, worth while sessions of the delegates, and also amusement and get-together features. It is planned to cram every minute full of interest and enjoyment and everything points to a whirlwind convention that will live long in the memory of every visiting ham.

During the sessions of the convention, technical talks will be given on short wave transmission, Heaviside theory and other subjects of amateur interest by radio engineers of national repute. Government examinations will be held every day, and various commercial and amateur speed contests with prizes for the winners will be featured.

It is expected that the Hon. Frank E. Schwab, Mayor of the city of Buffalo, will deliver the welcoming address on the open-

ing of the convention, and various city officials will speak to the delegates at different sessions.

A trip to Niagara Falls where special colored illumination of the Falls has been arranged, and delegates will be taken on a specially conducted trip through the largest hydro-electric plant on the Niagara Frontier.

The various Buffalo broadcasting stations will be visited, and a special broadcasting exhibition will be put on by station WMAK.

The usual grand banquet with special eats and entertainment will be a feature, and a night of Mystery will give all the various thrills the most vivid imaginations can produce. Hotel Lafayette is located in the heart of the theatrical district, and there will be plenty of time for delegates to see several shows, and to visit points of interest in Buffalo.

Every effort is being made to keep the cost of a trip to the Buffalo convention well within the means of every amateur in the Atlantic Division. Special rates will be in effect on all railroads leading into Buffalo, attractive hotel accommodations have been secured, and a very low registration fee is promised. All "extra expenses" are being eliminated wherever possible.

A convention bulletin is now being prepared and will be mailed to all amateurs in the Atlantic Division. This bulletin will contain a complete outline of the program, amusements and trips—everything, in fact, except Hidden Delights of the Night of Mystery. These must be seen and heard to be appreciated.

Every Atlantic Division amateur is urged to get his reservation in as early as possible. All letters and reservation should be sent to The Radio Association of Western New York, 598 Masten St, Buffalo, N. Y.

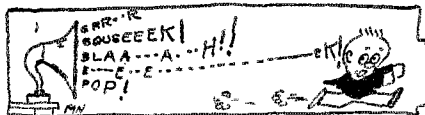

Strays

The Weston thermo-galvanometer should be mounted horizontally if use is to be made of the I²R curve accompanying these instruments. The curve does not hold true for instruments not mounted horizontally.

SOT tells of 8CXF interestingly watching the op at WTK "x-out" a word or so on a message he was copying. Whereupon 8CXF asked the op if he was putting down the static too.

Breaking Into Amateur Transmission

Part 2. Power Supply and Tuning the Transmitter

By John M. Clayton, Assistant Technical Editor

Note: It is absolutely illegal for you to test the Low Power Transmitter, or operate same, until you have secured both an Amateur Operator's License and a Station License, from the U. S. Government. The requirements for both are simple. You must be able to copy at least ten words a minute, Continental Code, and you must have an elementary smattering of radio transmitting and receiving circuits. If you do not know the code, refer to "Learning the Code by Listening," QST page 45, March, 1925. If you have been a careful reader of QST for any length of time you should know more than enough about transmitting and receiving circuits to pass the examination. First of all send 15 cents (not in stamps) to Superintendent of Documents, Government Printing Office, Washington, D. C., and get a copy of Radio Communication Laws of the U. S. Carefully study those portions of the law relating particularly to amateur operation, and read the whole thing through. Then write the Chief Radio Supervisor, Department of Commerce, Washington, D. C., asking for the address of the Supervisor to whom you should make application for blanks for Amateur station and Amateur Operator Licenses. Until you have secured your operator's license and station call letters, you must not attempt to operate the transmitter at all.

LAST month we gave complete constructional details of a very simple low-power transmitter. There now remains the filament and plate supply for the tube. The simplest solution is a small transformer having both filament and plate supply windings. A transformer of this type, especially designed for a single low-power tube is available at a very modest price.¹

For reference purposes the circuit of the completed transmitter is shown here again. This was Fig. 6 of the article last month. Fig. 1 illustrates the manner in which the small transformer is connected directly to the appropriate terminals on the transmitter. The transformer has three windings; a primary which is connected to the 110-volt alternating current house mains (through a protection fuse, 10-ampere size or smaller), a low voltage or filament winding which supplies current for the filament of the tube, and a third winding which gives a high voltage for the plate supply to the tube. The key is connected in series with the —B terminal on the set and either one of the leads from the high voltage winding. This is the simplest arrangement there is.

The above power supply is not entirely satisfactory since the 60-cycle supply is impressed directly upon the plate of the tube. The note emitted from such a supply source results in a signal in the air sounding very much like high-class static. If the signal is weak at the receiving end it is very difficult to copy. If we provide some form of rectifier to change the alternating current from the transformer to direct current, the emitted signal will be much easier to copy, will cause less interference and will penetrate static infinitely better.

There are a variety of ways in which the A. C. supply can be rectified. If you have a

B-battery eliminator giving a high voltage (at least 350) with sufficient output, the output terminals of the eliminator can be con-

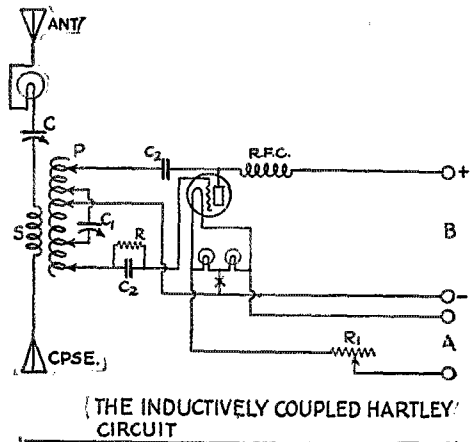

needed to the plus and minus terminals of the transmitter and the eliminator can be used to furnish plate supply. Vacuum tube rectifier tubes (identical with the UX-210 except they have no grid elements) can be

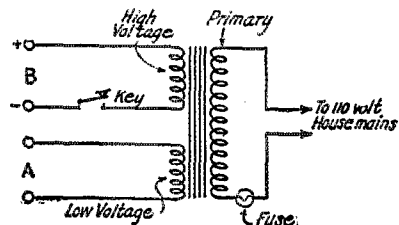

FIG. 1

hooked up to furnish direct current. Probably the simplest, and certainly the cheapest, is the chemical rectifier.

¹ Get in touch with the Thordarson Electric Mfg. Co., Chicago, or the Acme Apparatus Company of Cambridge, 89, Mass.

A chemical rectifier consists of a number of small jars each of which contain a strip of pure aluminum and lead. The aluminum and lead are immersed in a saturated solution of borax or other chemical compound. Two jars must be provided for every 40 volts there are to be rectified. Since the UX-210 can stand 500 volts of "B" (if the tubes are adjusted so that they will not have hot plates), we want to have this voltage available at the plate terminal. If we start with

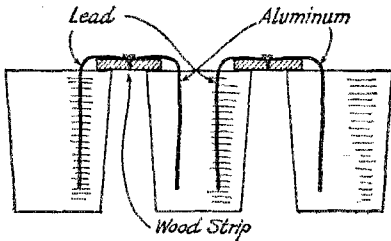

FIG. 2

a 600-volt transformer, by the time the current has been rectified and has passed through the filter we will have about 500 volts left. So, for our chemical rectifier we need a total of 30 jars. Ordinary "two for 5c" glass tumblers or jelly jars will be OK.

The make-up of individual rectifier units is shown in Fig. 2. A wooden strip long enough to keep the aluminum and lead pieces from touching the side of the tumblers, must be provided for each jar. The wooden pieces can be about 3/4 inch wide and 1/2 inch thick. The aluminum must be pure and each strip should be 3/4 inch wide, 4 inches long and 1/32 or 1/16 inch thick. Thirty such strips will be needed. The lead strips should have the same dimensions.² Each aluminum and lead piece is held together and to the wooden spacer by means of a wood screw, as shown in Fig. 2. The aluminum should be handled as little as possible, to avoid getting any dirt on it, and the lead should be cleaned brightly all over with sandpaper, emery paper or a small fine file.

The solution for the rectifiers is made by pouring out a sufficient quantity of distilled water ("A" battery water!) to fill all of the tumblers to within 3/4 inch of the top. The water should be measured and then another

tumblerful added for good luck, and all of it should be poured into a single container. It is next heated until it is quite warm and then the borax is added. The borax can be ordinary 20-Mule Team stuff. It will take between two and three packages of 20-Mule to form a saturated solution. Let it stand for several hours until the water has soaked up all the borax it will hold. Then pour the solution into individual tumblers.

The complete rectifier circuit is shown in Fig. 3. The transformer T is supplied with a center-tap on its secondary winding and must give the required voltage on each side of the center-tap. That is the voltage between the center tap and each outside wire should be around 600, and between both outside wires alone, 1200. Note the sequence of aluminum and lead plates. The aluminum is the positive end, and finally connects to the plus B terminal on the transmitter, after the current passes through the choke coil.

Without some sort of filter the rectified supply will not be anything like pure D. C. The filter shown in Fig. 3 will be perfectly OK. It consists of a choke coil L having an inductance of at least 30 henries, and two condensers C and C1 having a capacity of at least 2- μ fd. each. The parts for the filter can be B-battery eliminator chokes and condensers, obtainable at a wide variety of places.

Before the rectifier can be used with the transmitter it must be "formed." This process is gone through by allowing a small cur-

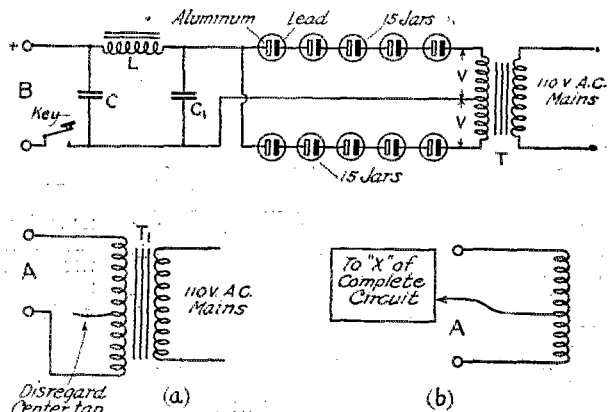

FIG. 3

rent to flow through the rectifier for an hour or so. The rectifier and filter are connected to the secondary of the plate transformer (Fig. 3) and then a 75- or 100-watt lamp is connected in series with the primary of the transformer as shown in Fig. 4. The lamp will glow fairly brightly at first and will gradually get dim. As it dims, an additional lamp is connected across the first lamp, and as they both become dim, still an-

² Refer to "Ham-Ads" in the back of QST. Complete parts for rectifiers are listed in these ads. Also all manner of transformers, antenna insulators, lead-in insulators and all items of interest and necessity to the transmitting amateur can be found listed in the Ham-Ads.

other lamp is connected across the other two. By keeping at the rectifier for an hour or so, the plates will be formed and the lamps can be cut out entirely. If the rectifier and transformer are connected to the 110-volt line without forming the rectifier, the resistance of the rectifier will be so low that it will constitute a short-circuit across the transformer secondary and the house fuses will be blown.

Transformer T1 is the filament heating transformer. A combination of filament and plate transformer can be purchased, or they can be procured separately. In either case the connections shown at (a) or (b) of Fig. 3 can be used.

This by no means exhausts the variety of possible plate supply systems. If one will spend quite a little more money a small motor-generator can be provided. The motor end operates direct from the house line and turns the generator which gives direct current for the plate. A filter such as the one shown should be used with the generator, but in general, the emitted note will be quite superior to that obtained from the chemical rectifier layout.³ A more expensive and idealistic form of plate supply can be obtained from dry B-batteries. The 45-volt size can be used. Approximately 11 blocks will be needed. Expensive but certainly beautiful!

The Antenna-Counterpoise

You will find that most of the amateur communication is carried on on wavelengths in the vicinity of 80 and 40 meters. The exact amateur bands are from 75 to 85.7 and 37.5 to 42.8 meters. For work in the 80-meter band (where you will probably want to get started) the antenna and counterpoise should have the following dimensions (approximately), referring to Fig. 5. The total length of the antenna from the transmitter itself to the insulator at the far end (A to B) should be about 62 feet. In like manner the total length of the counterpoise from A to C should be 62 feet, also.⁴

The antenna and counterpoise need have but a single wire. They should be insulated by means of Pyrex or some other high grade insulator, and the lead-ins should be brought into the house through a good insulator. Two holes in a pane of glass resting in a frame under a partly raised window make excellent lead-in insulators. To get started as quickly and simply as possible, the antenna and counterpoise lead-ins may be brought in through the crack in the window when it is partially lowered. This method is not recommended for extended use, however, as any

moisture in the wood will cause serious leakage.

Tuning the Transmitter

At this point you can very well enlist the help of some neighboring amateur (providing you have not been blaming all of the static, power leaks and other noises on him!). If you do not know any amateur near you, the local amateur radio club can get one of its members to give you a lift. Failing in each of these attempts you can proceed by yourself. The time expended will

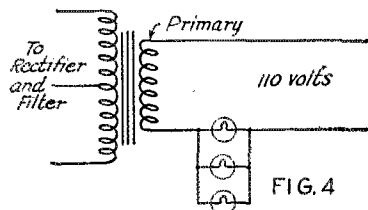

be well spent for you will learn a lot of things and will be in a position to know what you are doing, when you are through.

To start off, the plate and filament transformers are connected to the power line (through a switch so that you can cut off the line when you are not using the set), the rectifier has been constructed and formed and is connected to the transmitter, and the filament transformer's secondary terminals have been connected to the "A" terminals on the transmitter.

Turn on the rheostat and close the line switch. The filament in the tube lights. Fine! Turn the rheostat in one direction or the other until the filament itself is about the same brilliancy as that in a 201-A tube.

Now, refer to Fig. 3, page 10 of the April issue. Note the settings of the clips on the main inductance and try to duplicate them in your set. The two clips at the rear of

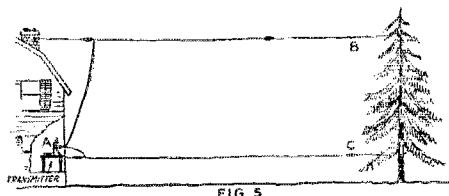

the photograph are connected to the tuning condenser (C1 of the complete circuit). The three clips (in the photo) toward the panel, from left to right, are grid, Xmas tree center-tap and plate connections. Set the clips on your transmitter in approximately these positions. Tune your receiver to some amateur signal operating in the 80-meter

³ Get a catalog from the Electric Specialty Company of Stamford, Conn. This concern manufactures a wide variety of generators for amateur use.

⁴ See "Antenna-Fundamentals" on page 46 of this issue.

band, and leave the receiver oscillating. Disconnect the antenna and counterpoise leads from the transmitter, for the moment disregarding the right hand condenser in the transmitter. Keep the headset on, hold down on the key and at the same time slowly turn the variable condenser on the left of the transmitter. If the transmitter tube is oscillating, when you swing the variable condenser through the wavelength to which the receiver is tuned, you will hear a very loud buzzing noise in the headset. If this noise appears over a wide part of the condenser, move the receiver further away from the transmitter. If, on the other hand, you do not hear any buzzing at all the tube in the transmitter is not oscillating. Move the center-tap clip a turn or two toward the plate clip. Again vary the condenser and listen for the buzz. When you do find it, it should be at only one sharp definite point, and should be very loud. When the buzz has been found, connect the antenna and counterpoise to their terminals on the transmitter, and place the secondary coil in the position shown in Fig. 3, last month.

Now hold down on the key and slowly vary the antenna series condenser, all the time watching the lamp in the antenna circuit closely. When resonance between the primary and secondary has been secured the lamp will light up. As soon as the lamp shows signs of getting bright to the burning out point, you had better "close down" and put a short-circuit directly across the terminals of the lamp. A piece of No. 28 or No. 30 D. C. C. magnet wire will do the trick. The lamp will not burn as brightly with this "short-circuit" as it will without it, and hence will be protected from actual burn-out.

If during any of these adjustments the plate of the tube gets hotter than a very dim cherry-red, move the center-tap clip further away from the plate clip and at the same time start over and readjust the condenser C1.

After the lamp has made to burn as brightly as it will you can monkey with the coupling between the antenna and the primary coil. If the antenna coil is brought too close to the primary, the tube will stop oscillating. Either loosen the coupling between the coils or slightly detune the antenna circuit by turning the antenna condenser a bit.

After the set has been tuned, try varying the center-tap clip back and forth a turn at a time until the adjustment has been found (with the antenna returned every time the clip is changed) at which the lamp in the antenna circuit burns brightest and the plate of the tube barely shows any color at all.

For 40-meter operation it is preferable to erect another antenna and counterpoise. They should be 30 feet long. The above process is repeated, first adjusting the re-

ceiver to a station in the 40-meter band, and using a lot smaller number of turns in the plate and grid portion of the coil.

Bear in mind that all of the adjustments are more or less tied together. A change in any of the clip positions or the slightest variations of the condensers will cause for a corresponding readjustment of the other elements. One can always stop and start over from the beginning, and with a little time and with patience the transmitter can be adjusted and made to put power into the antenna.

When this happens your stage is all set for some of the best fun you ever had in your life. Detailed instructions on operating will be found in the Communications Section Handbook. This book will be ready very soon. Watch forthcoming issues of QST for an announcement concerning it, and by all means get a copy.

Strays

At this writing it still is impossible accurately to analyze the status of pending radio legislation. The White Bill, modified and bearing the new number H.R.9108, was passed by the House on March 15th by a vote of 218 to 124, with an amendment which deleted the anti-monopoly provisions of its Section 4. H.R.9108 differed from the previous White bill mainly in having its radio commission consist of five commissioners, one from each of five radio zones established for that purpose, rather than a commission of nine, one from each inspection district.

The Senate Committee on Interstate Commerce has held hearings on the various radio bills before it but has not reported any of them. Rumor had it for a while that the Senate committee favored still another legislative idea in which radio administration would be under the control of the Interstate Commerce Commission, but Senator Watson, chairman of the committee, has denied this. Meanwhile pressure is being put on the Senate committee from many sources, urging them not to delay action. Sentiment leans towards the White Bill, already passed by the House, and Senator Watson has expressed the belief that legislation will be enacted before Congress adjourns.

The Magnavox Company offers prizes aggregating \$62.50 for the best three-to-five-word slogan summing up the superiorities of the new Magnavox tube. The slogan must be easy for the layman to grasp. The Magnavox Company will be the only judges and the contest closes June 15th. Address, "Magnavox Contest", The Magnavox Company, Oakland, Calif.

Simplifying Operating

THE wide variety of unreadable "fists" on the air, the extremely sloppy sending on the part of amateur radio operators, the misguided attempts at high speed sending by some of the ham operators who should be going at 10-per instead of sliding along at 25,—these if nothing more than justify an article of this type which, it is hoped, may cause a lot of the gang to see the light and improve operating conditions by first improving their own fists.

Happily this improvement can, at the same time, be accompanied by an actual simplification in the labor involved in key-punching.

Many many years ago it became apparent that if the telegraph companies of the U. S. were to maintain their excellent operating personnel it was going to be necessary for some one to devise some form of semi-automatic transmitter to help along the excellent old-timers who had sent so much Morse that they had become afflicted with that dreaded form of paralysis called a "Glass-arm". Operator after operator found that gradually his speed was being lost and if he continued to telegraph actual paralysis of the nerves in his arm and wrist set in and he was forever lost to the art of telegraphing.

Then along came the semi-automatic transmitter. The nerve-trying up-and-down key manipulation gave way to the easy side-slapping motion. Telegraphers with "glass-arms" found that they could come back into Morse and the average speed of transmission soon reached a much higher level than it ever held before.

And along came radio (then wireless). The semi-automatic transmitter was well established. Not many high speed Morse wires were without these instruments and radio operators readily took to them. Then followed quite a few years of hectic operation during which time the manipulators of these devices carefully removed all the speed control weights and attempted to tear holes in the air. Gradually there was a swing back to proper manipulating and we have the semi-automatic transmitter operation as it is today.

The semi-automatic transmitter consists of either a single or double lever arrangement whereby one presses the lever to the right and a quantity of dots are sent. When the lever is pushed in the opposite direction a dash is made as long as the lever is held over. This, simply, is the basic principal of all of the machines. The speed of the dots can be regulated by moving one or two weights toward or away from

the operator, and along the arm at the end of the long lever.

Invariably for radio telegraph work the dots should be made as slowly as possible. On some machines, especially those designed for high speed Morse lines, the two weights are not sufficient. An additional weight should be provided, or a piece of wire solder should be wrapped around the weights. This is the first principle of "bug" operation. *Slow down the dots, and leave them slow.*

In learning to operate one of the semi-automatic transmitters, by all means rig up a simple buzzer and battery circuit and send to yourself. If you are used to ordinary key transmission you are almost as much of a green-horn as the fellow who does not know continental, when it comes to bug-sending. The second rule, then, is *send to yourself* until you are thoroughly convinced that you can send good Continental.

As in straight key work, the arm should be rested on the table using the muscles in the forearm as one of the points of contact with the table. The other point is at the base of the hand. Merely lay your arm on the table and roll it over until the thumb and fingers are straight up (at right angles to the table) and you have the correct position. *Do not grasp the levers.* The operation of the bug is accomplished by rolling the arm slightly back and forth so that the hand is slapped against the dot and dash lever, rolling the arm to the left for dots and the right for dashes. The thumb, for dots, will bump against the dot lever and

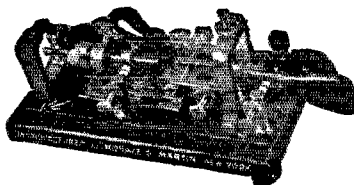

The Vibroplex. Made in either single or double lever type. A special "radio" model with large contacts available. Made by the Vibroplex Company of New York City.

the first finger, when the arm is rolled toward the left, the dash lever. Again, *do not grasp the levers between the thumb and first finger.* Merely slap the levers with the finger, pausing long enough to send the requisite number of dots or the proper length of dash.

In learning to use the semi-automatic transmitter take plenty of time and leave large, wide open spaces between letters and words and make the dashes amply long. Aim solely at accuracy, *the speed will come later on.*

After you are thoroughly familiar with the working of such a key you are ready to try it on the radio transmitter. The key will need some adjustment. You had better

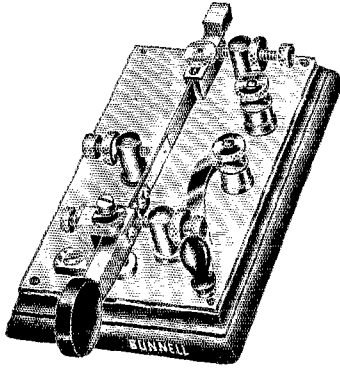

The "Gold Bug" of the Bunnell Company of New York. A single lever, medium priced transmitter.

get some fellow at a distance from you to test with you while you get the dots tuned up. The dot contact must be adjusted so that the dots themselves are much longer, or "heavier" than they are for landline work, or on the buzzer. Here is where the DX test fellow comes in. Adjust the dot contact until the dots are of the proper length, not like a series of bullets from a machine gun, and not so heavy that they can be mistaken for short dashes. Once the correct adjustment has been found, for the love of Mike *leave it alone*. All this time the

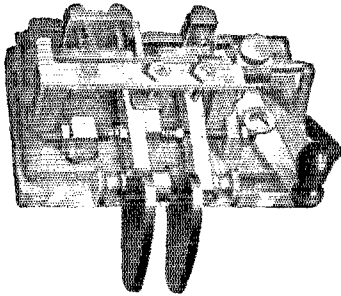

The Ultimate Transmitter. Made by the Ultimate Transmitter Company of Los Angeles. A new semi-automatic transmitter with several new features.

weights on the lever should be at the far end of the lever and they should be left there. Until you have used a bug regularly for a year you should have the dots coming very very slowly. At the end of that time if you want to you can speed them up a little, but watch out or you will absolutely ruin

what can be some of the prettiest transmission you ever sent out!

Summarizing, slow down the dots, send to yourself on a buzzer until you can send perfect Continental by the half hour, send slowly and shorten the interval between letters and words to gradually increase your speed, get the bug on the air by actually getting an intelligent operator at the other end to tell you when the dots are not too light and not too heavy and lastly leave the weights alone. Some of the prettiest radio transmission there ever was, was made by a good operator with a good bug rocking along at 18 words per minute. If you don't believe you can push more traffic this way than by trying to send chain-lightning dots, listen to some of the few good bug transmitters and see for yourself.

—J. M. C.

A.R.R.L. Information Service Rules

1. Before writing, search your files of QST. The answer is probably there.
2. Do not ask for comparisons between advertised products.
3. Be reasonable in the number of questions you ask.
4. Put the questions in the following form:
 - A. Inclose a stamped and self-addressed envelope. Envelope without stamp from foreign countries.
 - B. Make diagrams on separate sheets and fasten sheets together.
 - C. Number the questions and make paragraphs of each.
 - D. Print the name and address (NOT merely call letters).
5. Address all questions to Information Service American Radio Relay League, 1711 Park Street, Hartford, Conn.
6. Keep a copy of your question and diagrams and mention that you did.
7. State whether or not you subscribe to QST.

Strays

"With the aid of a *low pressure* transmitter these amateurs were able to be heard in England. . . ."—*Iowa Homestead*. Why not? Don't they use vacuum tubes?

Some bird wants to know if the red "QST" on our letter heads is the A. R. R. L. Inc.

A Reflexed Receiver with Resistance Audio Coupling

By L. W. Hatry*

IT is interesting to prologue the discussion of the circuit given in this article, with references to those who have previously used resistance coupling in the audio circuits of a reflexed tube.

J. E. Roberts has sent me a modified version of his well known reflex circuit, altered to use resistances as audio couplers. This circuit is shown in Fig 1.

Gardner and Hepburn of Philadelphia, make a very neat little reflex set using 5 tubes. This set is called the *Rectaflex*. One tube is reflexed with the result that the set has a stage of tuned R. F. amplification, a detector, and 4 stages of resistance-coupled audio amplification. The detector by the way is used without a grid condenser. As stated in the January issue of *QST*, I too found that the detector in a reflex set seems more certain to work well if the condenser is not used. The reflexing method used in the *Rectaflex* is identical with that of Fig. 1, and one can draw the rest of the circuit without the need of a further illustration.

Daven, of resistance fame, has experimented a great deal with reflex circuits in general, trying to develop a satisfactory circuit of this type with resistance-coupled

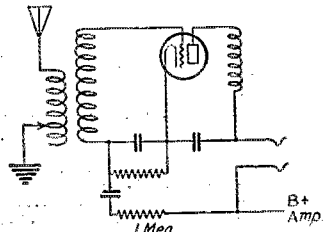

FIG. 1 SHOWING ONLY THE REFLEXED TUBE

The connections of the reflexed tube in the *Rectaflex* and in the modified Roberts circuit.

audio amplification, but in general has not been satisfied with the results. Briefly his objection is that a reflex set is hardly an economical device. After all, one doesn't save much when the set as a whole costs \$60, and the saving due to reflexing is represented by a single tube worth \$2.50.

How Many Stages of Reflex?

Just as we did with the transformer-coupled reflex, we come to this: that the reflexing of a single tube is not difficult nor

troublesome—but neither does it effect any saving worth considering. The multi-tube reflex is a troublesome device to build, but it

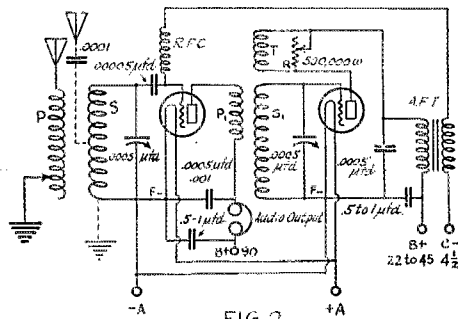

FIG. 2

A reflex circuit with two tubes. The detector is provided with resistance control of the regeneration.

A set of this sort can be made up conveniently from a pair of the tuner units made by the National Company. The first R. F. transformer winding S, may be provided with a primary P, wound directly over the existing winding or else the present winding may have the antenna connected to the tap thru a .0001 microfarad fixed condenser as shown by the dotted lines. The transformer P' S' T, may be the other type of National unit, the pickup coil being used as a tickler. The builder can suit his own notions as to control, either rotating the coil T or else fixing it, and controlling regeneration by means of a Centralab high resistance R, shunted across T.

represents a real saving in tube cost and battery consumption.

Psychology—or Plain Pride?

There is another thing about the multi-tube reflex that provides it with a sound foundation. One is always striving to out-do the usual. There is a lure about doing much with a few tubes. It is made up with as much satisfaction, as a treat to the vanity. Imagine the sensation of having a visitor sit down to listen to a 3-tube reflex set, and he expects the normal "regenerative detector plus two audio" results. Instead of that, the set gives results that more nearly resemble those of a 4-tube set of the variety that uses a stage of R. F. and a regenerative detector after that. The visitor expresses pleasure and admiration, which in turn pleases the reflex owner.

Getting Down to the Set

Figure 3, shows the circuit of a set which uses the circuit we have been leading up to—that is; it uses three tubes, of which two

* Radio Technician, Hartford Times, Hartford Conn.
—Page 17, January 1926 QST.

are reflexed and the third is the detector. A fourth tube is used as a final audio stage (outside of the reflex scheme) for the reason that it is required to give satisfactory audio volume when using resistance

is no difficulty with uncontrollable feedbacks.

A number of circuit arrangements was tried and a few things were learned; the main one being that the circuit of Fig. 3, appears to be as good as any and at the same time permits the use of standard parts.

A peculiarity of this circuit is that if the R. F. amplifier oscillates strongly, very severe blocking occurs without any regard to the grid resistances. This blocking seems much less likely to occur, in fact is difficult to produce, if the leaks for the tubes are not taken through the R. F. chokes, but provided as suggested in Fig. 4. However, if the R. F. circuits are neutralized by one of the standard methods, there will be no trouble with blocking.

As was stated in the January article, the Grimes method of inverse reflexing² should prove sound for a resistance-coupled set. This proved true. A check-up of circuit shown in Fig. 3, will show that the inverse method is used.

The Tubes

"High-mu"³ tubes, in case of Daven type 20, are used in all the reflexed stages as well as in the detector socket. 201-A tubes will work well enough, although the audio amplification with low-mu tubes in a resistance-coupled audio amplifier. Of course

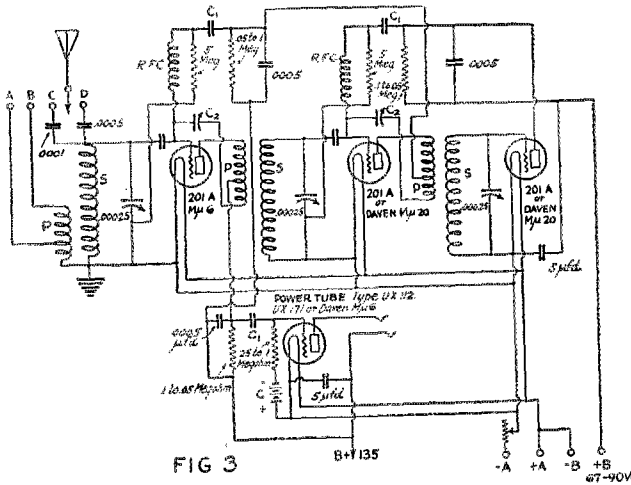

Fig. 3. A practical 4-tube reflex with resistance audio coupling. The first two tubes operate as R. F. and audio amplifiers, the third tube as detector, and the last as a final audio amplifier. The R. F. transformers, except the first, are Harper (Cribben) "metaloids." The first R. F. transformer is made for the set and is wound as follows: secondary 45 turns No. 22 D. C. C. wound on 3" tube, primary, 25 turns wound directly over secondary and tapped at the 10th turn. A 500 unfd (.0005) variable condenser is used across the secondary as shown in the diagram. The other R. F. transformers are tuned by means of 250 unfd (.00025 unfd) condensers.

C1 1/10 microfarad condensers.

C2 Midget variable condensers, capacity 30 unfd Max. I. e. .0003 unfd.

coupling. This is excusable when one considers the improvement in audio quality—and after all there are still only 4 tubes.

It is obvious to anyone who has paid any attention to the circuit in the January article that this present circuit is practically the same, save that resistances take the places of the audio transformers of the older circuit. The original intention was to reflex all three of the audio tubes, but lack of time, plus lack of funds for the purchase of a tandem condenser which would reduce the number of controls, prevented doing that. It also seemed best to try the resistance-coupling idea first with variations of the present arrangement, before proceeding to the troublesome 3-stage R. F. amplifier.

The Principle

The one purpose of this circuit is to reflex in such a manner that the R. F. circuits are as thoroughly isolated from the audio circuit as possible.² By the judicious use of both, chokes and condensers, this has been carried to at least such a point that there

2—Various devices have been used by the author in this connection.

One is to shunt-feed the tubes thru R. F. chokes, in contrast to the usual practice of leading the R. F. right to the terminals of the audio transformer, and then making a feeble attempt to prevent trouble by means of a bypass condenser. Another device has been to use the R. F. bypass condensers across the audio transformers but with R. F. chokes interposed so that the R. F. is not merely allowed to avoid the audio transformer, but is definitely obstructed in its attempt to reach the A. F. transformer. The benefits of these schemes appear mainly as improved audio quality. In this connection it is interesting to note that a very little R. F. fed into an ordinary audio amplifier, will ruin the audio quality nearly completely.—Tech. Ed.

3—That is to say, a scheme as follows. If we number our tubes 1, 2, 3 then the usual "straight reflex" will use them as follows—1 and 2 as R. F. stages, then 3 as detector, 1 and 2 again as audio amplifiers. The order is therefore 12312. In the inverse system the order is 12321. The system was originally described in this magazine, see page 7, issue of March, 1923.—Tech. Ed.

4—That is to say, tubes having a high voltage amplification, high plate impedance; have only moderate mutual conductance. With resistance coupling such a tube gives larger amplification than the usual tube with low mu and low plate impedance, but high mutual conductance. With transformer coupling the reverse holds.—Tech. Ed.

the effect with the high-mu tubes would have been still better had the R. F. transformers been re-constructed with sufficient primary turns to match their impedance. Time was not available for the work necessary.

Construction Hints

The usual large-size coupling condensers should be used, for the capacity C. preferably not less than .1 microfarad or more than 1 microfarad. The well-known .006 microfarad condenser often used is *not* right, but a purchased resistance-coupler can be made satisfactory, by connecting a .1 microfarad condenser across the small condenser as shown in Fig. 5. The lower notes in the

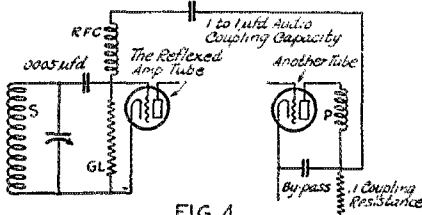

FIG 4

Method of connections used to avoid blocking when the R. F. stages are not neutralized. This scheme is not needed with the circuit of Fig. 3.

audio spectrum will drop in volume if the smaller capacity is used.⁵

Neutralizing in a reflex of this sort is a cut-and-try procedure. There are no satisfactory rules to offer—or at least I gained no inking of them while experimenting.

The advantages of canned coils in build-

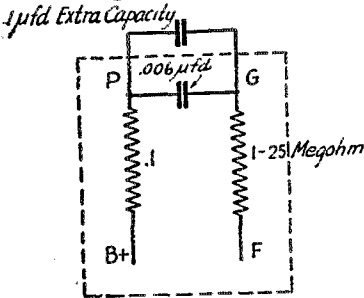

FIG 5

Fig. 5. How to improve the ordinary purchased resistance-coupler, so that low tones will be reproduced better. The part of the equipment inside the dotted line is the original purchased unit.

ing a set behind a small panel are very noticeable. Any good R. F. transformer will do, however.

By-Passes

In neutralizing such a set it is valuable to have large by-pass capacities as shown

⁵—But, it takes a really good loud speaker to show the difference. Practically none of the horn types will show the improvement—although there is an exception or two.—Tech. Ed.

in Fig. 3, (the condensers marked “.5 microfarad”). Sometimes these condensers are not necessary but more often they are. In a reflex of the type of Fig. 2, using a regenerative detector circuit, the by-passes at the detector and amplifier B batteries are very necessary to permit neutralization, and to permit quiet operation with an efficient transfer of energy from the R. F. tube to the detector.

The detector B voltage in the circuit of Fig. 3, (with a tube having a mu of 20 or more), is generally 90. Some value between 90 and 45 may be found better on

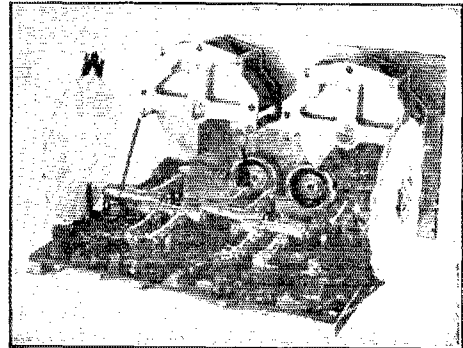

THE GARDINER & HEPBURN “RECTOFLEX”
This set uses resistance-coupled audio, of which one stage is reflexed in the manner suggested by Fig. 1. The two coils are the inductances of the R. F. amplifier and are tuned by the variable condensers. The fat cartridges are the coupling capacities, while the slender ones are the grid leaks and plate resistances.

some tubes. This may be determined by experimentation. The value is not critical, so 22 volt jumps are exact enough. A 201-A tube in this position requires a 67½ volt battery consistently.

In general, the performance of the set shown in these photographs has been satisfactory. The results closely approximate those obtained from an ordinary 6-tube Neutrodyne using resistance coupling in the audio amplifier. Better results would almost certainly have been obtained if (as suggested before) the R. F. transformer primaries had been re-wound to fit the tubes.

It will be noted that the grid leak resistances depart from the conventional sizes of a resistance-coupled audio amplifier. The values shown are not necessarily the best in all cases. In each circuit that was tried 1/10 megohm leaks were used throughout. The plate resistances should be of about .05 megohms (50,000 ohms) for either the 201-A or the high-mu tube. This size is generally hard to get, therefore the .1 size may be used ordinarily.

Impedance coupling may be used in the audio end of things. The impedances take the place of the plate resistances. The im-

pedances need not have a greater inductance value than 75 henrys for the 201-A or 100 henrys for high- μ tubes. B voltages of 90 can be used on the reflexed tubes in that case, although 135 does no harm if the R. F. circuits are carefully neutralized. The power tube that finishes the circuit should have a plate voltage of 135. Appropriate C voltages should be supplied through the grid leaks. 4.5 volts is correct for a plate voltage of 90 and at least 9 volts for a plate voltage of 135. Old style audio transformers of good make (such as the Acme

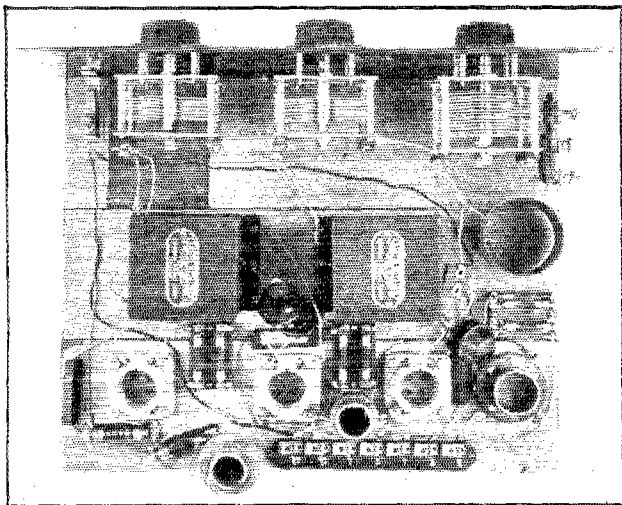

A 4-TUBE REFLEX SET BUILT ON THE CIRCUIT OF FIG. 3.

At the front of the set are the three tuning condensers for the two R. F. stages. Just behind that (from left to right), are the fixed antenna series condensers, the input transformer (R. F.) and the two Harper-Cribben "metaloid" interstage R. F. transformers in their copper "cans." The knobs that appear to have nothing attached to them, are the ones controlling the small neutralizing condensers (C2 in Fig. 3). The shunt-feed R. F. chokes, stopping and coupling condensers, and the resistance-coupler units can be identified upon inspection. The terminals on the strip are from left to right: Antenna, Ground, minus and plus A-battery minus plate battery, detector plate positive, and amplifier plate positive. The terminal strip of this rough set did not provide for the C-battery of the last tube which was therefore connected directly at the tube socket.

$4\frac{1}{2}$ to 1 or the Amertran or Thordarson $3\frac{1}{2}$ to 1 or 5 to 1), make good impedances, using the secondary windings only.

I want to give one tip with regard to the further job of reflexing three stages. The last tube should be a power tube, such as the Mu-6 or the UX-112. With inverse reflexing, this would also become the first R. F. tube. The impedance of the plate circuit of a tube of this sort is low, consequently the R. F. transformer fed by this tube should have comparatively few primary turns in comparison to the number required by the Mu-20 tubes.

And now—Good Luck!

Strays

Although all of the short wave commercial transmitters operated by the Radio Corporation of America are more or less experimental and have their apparatus changed frequently, the R.C.A. informs us that WIZ at New Brunswick has been developed to a point where things will be left alone for a while, and supplies us with the following data descriptive of WIZ: The transmitter is a power amplifier-master oscillator affair. The master oscillator which is keyed in its grid circuit, feeds through an intermediate amplifier to the main amplifier using two water-cooled tubes. The last stage of power amplification has a tank circuit which is inductively coupled to the antenna. The plate supply for the master oscillator and intermediate amplifier is obtained from a six-phase 60-cycle rectifier giving 2,200 volts, D.C. The plate supply for the main amplifier is obtained from a similar rectifier that delivers 10,000 volts to the plates of the tubes. The smoothing of the high voltage D. C. is not complete, having a modulation of about 20 per cent. The maximum output has been as high as 16 kilowatt but the usual operating value is between 10 and 11 kilowatt. The antenna at WIZ is a single vertical wire extending 105 feet above the coupling coil of the transmitter. The antenna is suspended from a steel tower and separated from it by a twenty foot length of varnished rope.

Amateur radio, neither transmitting or receiving, is permitted in the Dutch East Indies. The official in charge is hostile to Amateur Radio. However, the Amateur Organization is Nederlandsch Indische Vereeniging voor Radiotelegrafie (Nederlands Indian Union for Radiotelegraphy). The correspondence with members should be addressed to Bothstraat 3r, Soerabaja, Java, Dutch East Indies. The amateur magazine is "De Antenne": address, Bilitonstraat 25 Soerabaja, Java, D.E.I.

Picking a Good Antenna for the Short-Wave Station

By C. H. Starr*

MANY people can't understand why some short-wave stations obtain better results with very low power than other stations having more power and more elaborate apparatus. I believe the answer lies largely in two things—a steady note and a good antenna. Most amateurs fully realize and take note of this but there are some, principally the newcomers in the amateur ranks, who do not fully realize the important part played by the antenna in regard to the results obtained from a transmitter.

Appearances Are Deceiving

During the past few months some twenty different antennas have been tested at my

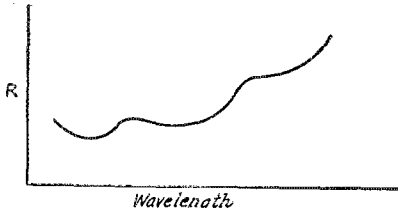
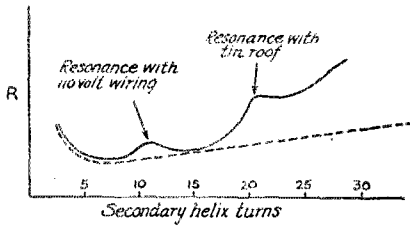

FIG. 1

"The curve will show humps."

This curve is taken from an undersized antenna which is loaded to reach the working wavelength and does not use a series condenser. Two possible ways of making the curve are shown. In the case shown the 110 volt line was protected by the use of R.F. chokes and the tin roof was solidly grounded. This gave the dotted curve. The curves were from work done by the Technical Editor at old 3ABI in Washington, D. C.

station. One of the most important things these tests impressed upon me was that one can tell *practically nothing* about an antenna by its looks. This possibly explains why some stations get such good results with antennas that look very poor indeed.

Antenna Measurements.

The only satisfactory way to find out the whys and wherefores of any electrical apparatus (especially when one can tell but little by looking at it) is to make *comparative* measurements. This applies particularly to transmitting antennas—the measurements of one antenna mean little unless one has those of the other so that one can be compared with the other.

Now at frequencies below 2000 K. C. (wavelengths above 15 meters) antenna measurements are quite easily made but at higher frequencies they are much more difficult. The resistance measurements are especially difficult to make because most short-wave antennas are operated below the fundamental which results in a very high resistance. Measurements of the field strength nearby are of very little help because the valuable energy is that radiated at a high angle, also because the polarization of the wave as it leaves the antenna is quite likely to have considerable effect on the ability of the station to "get out". To avoid these difficulties several dodges may be resorted to.

A Resistance Measurement Trick

If an antenna is operated below its fundamental where ordinary resistance measurements are difficult and inaccurate a method of indirect measurement may be used as follows. Put up a temporary antenna somewhat smaller than the final antenna will be, so that the unloaded fundamental will be slightly below the wave on which it is desired to operate. Load this antenna to the desired wavelength and make measurements in the usual fashion. The curve will show humps due to guy wires, resonant power lines, bad ground resistance and so on. Fig. 1. One can then correct these things as far as possible and then erect the larger antenna with a feeling that at least a good start has been made.

Field Strength Measurements.

Measurements of field intensity to be of value at short waves should be made at sev-

1. But hard to repeat. The conditions vary a great deal from day to day, except where one has excellent ground conditions. In our work at 8AQO we found that the antenna resistance changed as much as 10% when the dew dried off the grass in the morning!! This was with an antenna system having a very low voltage from counterpoise to ground. It would probably have been worse with a smaller C. P. and in any case one cannot be too careful to maintain the same conditions or else to check back constantly. —Tech. Ed.

* 8KA, 20 Wellington Street, St. Catharine's Ontario, Canada. Experimenter's Section A. R. R. L. I. A. R. U.

eral points at different distances from the transmitter and these distances should be very great—hundreds of miles. The reason for this is that the *shape* of the field changes a great deal with changes in antenna size and wavelength and one is quite as likely to be measuring a change of distribution of the field instead of an actual change in the radiated energy. These long-distance measurements are almost out of question for the average amateur station, therefore I will describe the method of comparison used at my station.

Each antenna system is tested for at least one week. The reports of signal intensity for this period are averaged and a record is kept of the ease with which stations are raised. Much more faith is placed in the second of these things. For instance—if I *regularly* log 3 or 4 stations answering a CQ I know that the antenna is working well, but if it *regularly* takes several calls to get one answer the antenna is “punk”—or else the weather is bad. To make the results positive one has to change back and forth several times between two antennas.

These methods sound decidedly hit and miss, but I have found them to work out very nicely indeed. It is surprising what a difference one can notice after having made a few changes in the antenna. Using one antenna system this station made 34 calls in 5 days but worked only 3 stations, a little over 8%. Leaving the transmitter and wavelength alone but changing antennas 66% of the stations called were worked and during the whole week no reports were re-

definite answer at present. I do not believe that a large antenna operated at a harmonic will be inferior to a small antenna operated at its fundamental provided that both are situated on the top of an open hill. It is certain, however, that a small antenna operated at its fundamental and surrounded by trees, buildings and receiving aeri-als will not give as good results as one that reaches well above these surroundings and has to be operated at a harmonic.” The same statement applies to a small antenna of which a large part is in or near a building. I have found that, as a rule, an antenna which is a good radiator at its fundamental is also good at a harmonic.

Good Antennas

A number of factors enter into the design of short-wave antennas which are of little

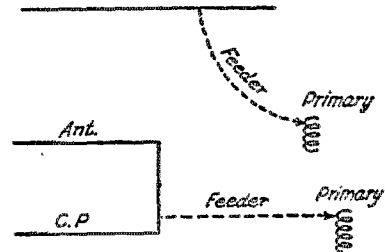

FIG. 3

“The common practice of attaching a single-wire transmission line directly to the driver is not to be recommended.” The coil marked “primary” is the one to which the tube is connected, i. e., the primary helix or driver circuit.

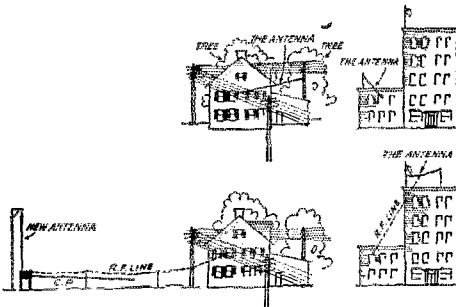

FIG. 2—“OR A SMALL ANTENNA—AT A DIFFERENT PLACE”

The advantages of the R.F. transmission line are suggested here. The line may be 1-wire but had better be 2-wire to prevent radiation from the line.

ceived of signal intensity less than “R7”—i.e. “readable thru much interference.” Of course the weather may have changed—the thing was not proved finally. To complete the job one needed to go back to the first antenna and get a check-back. The method, however, is simple and useful.

Harmonic Operation

Is fundamental or harmonic operation best? We have very little in the way of a

importance at long waves, although the rules for making a good antenna at long waves are equally important at short waves.” For one thing, if you can possibly keep a big antenna rigid and taut, use it in preference to a single wire. For another, keep the antenna well in the open and as high in the air as possible—just as you would at long waves. Although height is probably not as vital at short waves as at long waves it is still very necessary.

About the only way of overcoming the

2 This has always seemed reasonable to me although one must admit that the thing is badly complicated by the changes of field form when working at different distances below the fundamental. Mr. Melville Eastham is inclined to doubt the value of the idea of getting “into the clear” by using a large antenna a harmonic and to think that a *carefully constructed* antenna will operate equally well at the fundamental in the same location, even tho the system be made extremely compact by reducing it to the so-called “condenser antenna” form.—Tech. Ed.

3 It is tremendously difficult to make absolute statements about antennas. It is thru no fault of the author that this statement is rather strongly modified by the fact that below-fundamental operation of short-wave antennas frequently causes ground resistance to be unimportant so that it is an advantage to tolerate a few extra ohms for the sake of the extra height added by doing away with the C. P.—Tech. Ed.

shielding effect and power absorption of various buildings trees and wires is to get the antenna away from them. This means either using a big antenna at a harmonic or a small antenna put, at a different place and fed by a radio-frequency transmission line. Fig. 2. I have never seen one of these R. F. transmission line arrangements which did not give good results when properly ad-

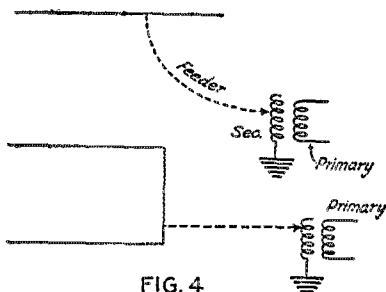

FIG. 4

"—or ground the feeder through a coil to which is coupled the driver." Another scheme will be shown in a following article.

justed. I say "properly adjusted" because they are sometimes very tricky to get going.

The common practice of attaching a single-wire transmission line directly to the driver (primary) Fig. 3 is not to be recommended, as it possesses all the advantages of any direct coupled system. Either use a very small condenser in series with the feed line or ground the feeder through a coil which is coupled to the driver (Fig. 4)⁴. With some types of antenna the two-wire or "untuned link" of type of R. F. line may be easier to use. One should also consider the "zeppelin type" antenna recently described in *QST* by Dr. Picard. This is practically a pair of Lecher wires one of which is $\frac{1}{4}$ wavelength longer than the other. The extension is the radiator.

⁴ There is trouble in this plan. Mr. John Strobel, former 8ZW, found that in the short-wave installation at KFKX, Hastings, Nebraska, it was necessary to use a choke coil instead of a condenser. This was to suppress the harmonics which are inclined to be unduly strong with a 1-wire feeder whose coupling is controlled by a series condenser. *Caution.* Any system of feeding antennas thru a 1-wire R. F. line is quite likely to make much the same troubles that are caused by a direct-coupled transmitter. To be sure of avoiding this effect the line should be coupled inductively to the primary as the writer suggests. This also avoids a part of the usual difficulty of these systems in introducing R. F. into the lighting lines. The entire matter of R. F. feeders in amateur transmission is in an uncertain state. We hope to present some useful material in our June issue.—Tech. Ed.

Medals for Conspicuous Radio Service

TO EVERY amateur, experimenter and BCL who is instrumental in alleviating human suffering or saving human life, directly or indirectly thru the medium of radio, the magazine *Popular Radio* offers recognition in the form of a medal known as "The Popular Radio Medal for Conspicuous Service." Unlike most medals in radio this one is not given for scientific achievement or invention, but for service to humanity. It goes in a field of performance in which radio amateurs are particularly active.

The complete rules governing the awards are published in April *Popular Radio*, to which interested readers are referred. The Committee of Awards, acting with the assistance of a representative Advisory Committee, consists of Hiram Percy Maxim, president of the A. R. R. L.; Dr. E. F. W. Alexanderson, chief consulting engineer of the Radio Corporation; Major General C. McK. Saltzman, Chief Signal Officer of the Army; Rear Admiral W. A. Moffett, Chief of the Bureau of Aeronautics, U. S. N.; and Dr. John H. Finley, publicist and journalist. The secretary of the Committee is Dr. E. E. Free, who may be addressed at 627 West 43d St., New York.

The medal itself has been designed by the well-known artist, Walter D. Teague. It is two and a half inches in diameter, cast in monumental bronze, with a space for engraving the name of the recipient.

Awards will be made for worthy services rendered since Armistice Day, November 11, 1918, and will be made to as many individuals as qualify for it in the judgment of the Committee of Awards.

Radio amateurs countless times have performed services which make them eligible for this award. Emergency communication of many kinds has been conducted by amateurs with conspicuous success in the alleviation of human suffering. Worthy cases of this sort should be brought to the attention of the secretary of the Committee of Awards. If our own members are too modest, perhaps their friends will feel that it is only just to bring forth their accomplishments, that their light be not hid under a bushel. Surely a fair proportion of these medals belong in the amateurs ranks, for no class has been so noteworthy in works of service to the community as the transmitting amateur. If Headquarters can help in the presentation of any cases, we shall be glad to do so.

—K. B. W.

A Dry Electrolytic Rectifier

By Robert S. Kruse, Technical Editor

AN electrolytic rectifier is really a beautiful thing; no expensive tubes to burn out, no moving parts to make a noise or get into trouble, nothing to set or adjust. That's the way it looks until one starts to build one of the brutes and discovers all the weird things that the solution can do in the way of turning green, brown and purple, crawling out of the jar and playing hob with the rugs and the floor. Some solutions will even grow a rich layer of mould which smells worse than it looks.

There are such things as good electrolytic rectifiers with solutions in them, but the makers guard the formula of the solution as if it were written on bank notes, all except one outfit which is lucky enough to use a metal element that they control exclusively—or at least so completely that we have never found a way to obtain enough of it to make a rectifier. Even these good rectifiers can be spilled, and the housewife is always violently suspicious of anything that is "messy".

Now a *dry* electrolytic rectifier—ah!

Very well; there is such a thing. The inventor is Samuel Ruben, research laboratorian; perhaps known to some of you through his vacuum tube work, especially on the Ruben relay. A dry rectifier obviously has a number of uses—each one taking

with Mr. G. N. Sieger, manager of the Elkon Works.

The Principle

The Ruben rectifier (now the Elkon charger) does *not* use a solution. It uses only a pair of discs between which is formed a film that performs the rectification, although no moisture is present other than

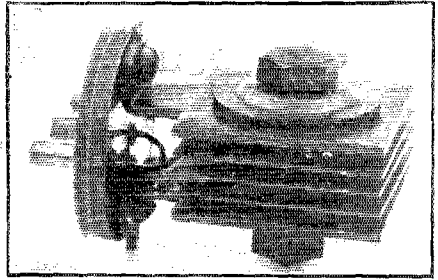

THE RECTIFIER UNIT

A single rectifier unit removed from its socket into which it fits like a tube. The A. C. input is supplied thru the two side pegs. The negative D. C. output is taken from the center peg, the positive from the two lugs formed by bending the two standards out at the base. These lugs also enter the slots in the socket shell and hold the unit in the socket. See Figs. 1 and 3 for additional details.

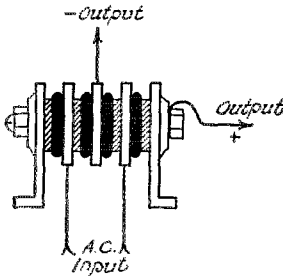

CONSTRUCTION OF A SINGLE UNIT

The shaded washers are those of magnesium and the thick dark ones are the composition affairs. The white rectangles are the copper pieces which act as connection terminals. The two end terminals are connected by the copper clamp-bolt; the whole, forming the positive terminal. All of the other parts have openings large enough so that they do not touch the clamp-bolt. Note that this is a full-wave rectifier unit of the bridge-connected variety.

careful work to make it commercial. The process has been carried out for one of these applications and the Elkon Works, of Weehawken, N. J., are marketing a trickle charger. The story about it that follows is based on interviews with Mr. Ruben, and

that which happens to be in the air. Do not misunderstand the last remark that the discs attract moisture from the air; they are quite dry. One of the discs is of metal, the other one of a composition. Since it is simple chemistry to find out that much, we may as well tell you that the metal disc is made of magnesium and the other one contains quite a variety of things of which the most prominent are crystals of a copper compound. The exact composition and treatment of the compound disc determines the life; current rating and breakdown voltage of the rectifier. To find the method of preparing the best discs for a particular job (for instance trickle charging) is a long, slow business, calling for a great many tests. Naturally enough one doesn't give such things away.

Very well, the rectification takes place between the two discs. How? That's hard to say. None of us are even sure *how* familiar rectifiers as a crystal detector, or aluminum-lead-borax rectifier work. Let us say that we have an "electronic reaction" between the discs. That is moderately correct and sounds as if some explanation had been offered. Incidentally, that's more of an explanation than we can offer to such a question as, "what makes the grass grow".

The Scheme at Work

As far as I know *all* electrolytic rectifiers wear out in time. In the familiar aluminum-lead affairs the aluminum and the

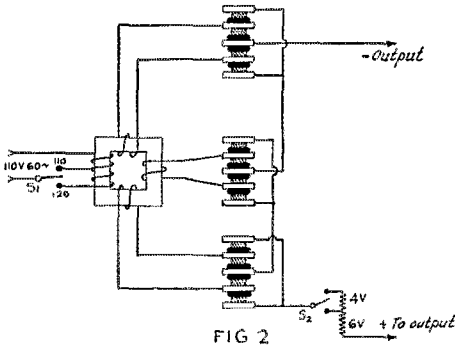
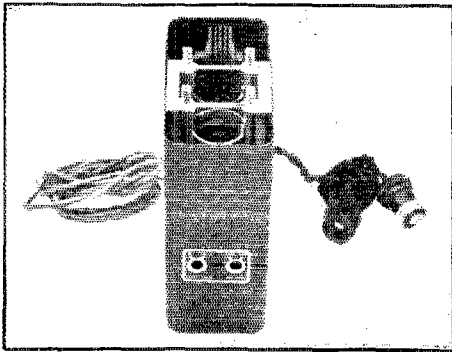

FIG 2

THE COMPLETE CIRCUIT OF THE CHARGER.
The three bridge-circuit rectifiers are shown with their outputs connected in series. S1 and S2 are the two switches which are set by means of a key thru the openings shown in one of the photographs.

solution both wear out. In the tantalum-lead-sulfuric acid rectifier the wear seems to be exceedingly slow, so slow that in practice it does not matter at all. However—unless I am mistaken—some sort of wear will happen in any electrolytic device, even when it is operated at very light load. That isn't the important point though. The real point is, that when one runs the voltage per pair (or per cell) above the proper point, the wear goes up at a tremendous



THE CHARGER MINUS LID

It shows two rectifier units in place and one removed. Note the two openings at the lower part of the case. These are the openings for the switch-key referred to in Fig. 2.

rate. A type of aluminum cell that will operate for hundreds of hours at 30 volts can be worn out in 20 hours at 90 volts, or in 20 minutes at 120 volts.

For the Ruben cell, the safe voltage is 15. If this is exceeded very much the life goes down very fast. If we are making a

charger for a 6 volt (3 lead cell or 5 Edison cell) battery one Ruben cell will not be enough, because the gassing voltage of the battery is 7.5 and the secondary voltage of the charging transformer must run above that to produce a charging current. The reverse voltage tending to break down the rectifier is the sum of these two voltages. If the R. M. S. transformer voltage is only 8, then the peak voltage will be 11 or thereabouts. Added to the battery voltage this becomes 18.5, which is too much for one cell, making two necessary. Actually, the transformer voltage is above 8 and the commercial charger uses three cells in series.

The Full-Wave Connection

Anyone who has ever operated a vacuum tube sending set with an electrolytic plate supply rectifier has learned how tremendously hard it is to make a number of cells

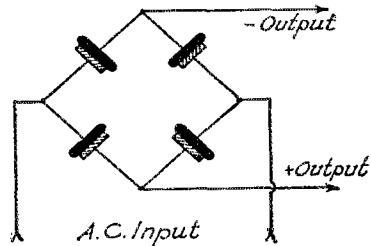

FIG. 3

This shows how the unit is equivalent to a bridge-connected rectifier system. The advantage of this over the center-tap connection is that the transformer needs fewer terminals.

operate decently in series. Some of them simply insist on doing nothing but making fireworks, while others go dead entirely and the remaining ones do the work. As a rule the cell gets worse rapidly and soon stops working. The result is that although one cell will handle 100 volts, it takes 10 cells to handle 300 volts, or 100 to handle 3000 volts—working half-wave all the time. There is a perfectly sound reason for this. If for any reason a single cell breaks down for an instant the remaining cells catch a little extra voltage. Pretty soon one of them pops and then the thing becomes general—just as condensers “blow” one after the other, when working in series.

The cure is to let each cell work from its own transformer secondary. In a 3000 volt sending set rectifier that would make a terrible mess, but in a 6 volt battery charger it is perfectly practical to operate several little bridge-type rectifiers from separate transformer windings and to connect their

D. C. outputs in series. The connections are shown in Figure 2.

The Life of the Device

As was said above, the lives of electrolytic devices shorten very fast if they are overloaded. On the other hand, if they are underloaded the life becomes correspondingly longer, especially when they are protect-

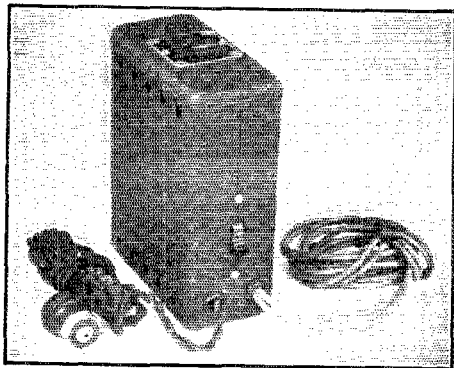

THE ELKON CHARGER COMPLETE
The trickle charger showing off-on switch, 110 volt input cord and rubber covered output cords.

ed from accidental excess voltages caused by broken-down cells. In a device like the Elkon charger the life is so long that one hesitates to name any specific longevity. The units are removable, they can be replaced if they do wear out, but the life in general is much longer than most charging devices.

BOOK REVIEWS

By R. S. Kruse, Technical Editor

Practical Radio and the Testing of Receiving Sets, Moyer and Wostrel, Published by McGraw-Hill Book Co., Inc., 370 Seventh Ave., New York. Price of second edition \$1.75.

It is the usual fate of radio books that they are obsolete when they first appear. Exactly the same remark applies to all technical printed matter whatever, and it is therefore not surprising that the famous technical publishing house of McGraw-Hill should have done an exceedingly good job of putting a book into circulation before it had drifted into history.

This reviewer admits—without any shame—that he has no previous acquaintance with the authors, but suspects that they could not have written this book without a store of radio knowledge that would make them well worth knowing.

Now that the publishers and the authors have been reviewed there remains only the book. It serves its purpose well in text and illustration, from the ubiquitous theoretical introduction right thru to the detailed constructional and repair chapters. What more is there to say than that?

Byrd Arctic Expedition Sails

Short-Wave Amateur Cooperation Again Requested

AS WE close our forms for this issue the Byrd Arctic Expedition is sailing from New York for Spitzbergen in another attempt to explore the region surrounding the "Pole of Relative Inaccessibility," the million square miles of unknown territory lying between the north pole and Alaska. The leader of the expedition is Lieutenant Commander Richard E. Byrd, U. S. N., who will be remembered as having been in charge of the aviation party on last summer's MacMillan Expedition to North Greenland. Short-wave radio again is to play an important part in the success of the undertaking and once more amateur co-operation is asked. We are sure that A. R. R. L. members will be interested in establishing and maintaining communication with this American expedition as they have done so successfully for former expeditions.

The party sailed on the S. S. "Chantier," call KEGK, which is equipped with a 500-watt 500-cycle short-wave transmitter. Base headquarters will be established at King's Bay, Spitzbergen, or possibly in North Greenland, from which aerial exploration trips will be made in a triple-motored Fokker monoplane. The Fokker carries a 50-watt crystal-controlled transmitter operating on 42 meters with the call KNN. We believe, although we are not sure of it at this writing, that the equipment was designed, built and installed by Malcolm P. Hanson of Washington. The operators on the "Chantier" are Lloyd K. Grenlie, formerly "GL" of NFV, and George H. James, formerly "XF" of NFV, both of whom will be familiar fists to the gang.

KEGK has schedules of half-hour duration as follows: With NKF (Bellevue, D. C.) on 20 meters beginning daily at 10 a. m., E. S. T., and on 40 meters beginning daily at midnight, E. S. T. With 2ZV (A. H. Grebe Co., Richmond Hill, L. I.) on 20 meters beginning daily at 10:30 A. M., E. S. T., and on 40 meters beginning daily at 12:30 a. m., E. S. T. Work with amateurs will begin immediately following the above schedules, i. e., on 20 meters at 11 a. m., E. S. T., and on 40 meters at 1. a. m., E. S. T. If because of continuous daylight in the northern regions KEGK cannot get thru on 20 or 40, she will drop down to 13 meters.

Confidential press messages addressed to the "New York Times" will be an important part of the traffic. Amateurs receiving any such messages are requested to forward them by collect telegraph, press rates, to the "Times" immediately upon receipt.

Please advise the Communications Manager if you hear or work KEGK or KNN.

—K. B. W.

New Tubes

THE following new tubes will soon be placed on the market by the Radio Corporation. We are sure that these announcements will be of particular interest to the readers of *QST*.

THE UX-200A HIGH SENSITIVITY DETECTOR

The UX-200A looks distressingly like the famous 201A tube. On loud signals it acts just like the 201A but on weak signals—that's another story.

The construction of the 200A is quite normal, inside and out but there has been added an atmosphere which greatly increases the sensitivity to weak signals.

The 200A, like the old gaseous 200, is a detector. If it is put in place of a 201A there will be no change on strong signals except a slightly greater tendency for the tube to howl with the grid leak normally used on the 201A. When a lower resistance is used this stops and one gets the impression that there really isn't any difference. Longer observation shows this guess to be entirely wrong—it is perfectly possible to obtain fair loud-speaker signals from broadcast stations that were totally inaudible with the 201A detector.

Turning to C. W. reception a similar difference is noticed *without* the tiresome tendency of the old 200 tube to hiss and "pop" and "motor boat". A slight hiss is noticed but it is steady and the tube is not choked by static or trolley pops as were the old gas tubes.

The nicest part is yet to be told—it makes very little difference whether the plate voltage is right or not. The tube works very well at 22 volts, or at 30 volts or at 40 volts and one can set the filament rheostat at a variety of positions with very small effect on the signals. This tube is certainly a pretty proposition if it can only be kept so in production. That looks more possible than did the conjurers' trick of trying to make gas tubes alike—nobody ever licked the job.

—R. S. K.

THE UX-171 AMPLIFIER

To the family of audio amplifier tubes has just been added the UX-171. The tube looks like a 201A—so many tubes look like a 201A—but it acts differently, just as do most tubes that look like a 201A.

The UX-171 is designed for the last audio socket of receiving sets and therefore is an "overgrown 201A" just as the UX-120 is an overgrown UX-199. In both cases the last-

stage tube has a lower amplification constant and a bigger filament. Therefore it will amplify weaker signals less—but it will give better audio quality on all signals, provided there is a decent input ahead of it and a decent loudspeaker after it.

The amplification constant is low, being but 3. The $\frac{1}{2}$ amperes filament operates at the standard voltage of 5. The plate voltage for this tube is 180 with negative bias of 40. At any plate voltage, however, the UX-171 will (with the proper grid bias) deliver more undistorted power to a loud speaker than the 199, 201A, 120 or 112. It is a particularly attractive tube for use with 90 volts on the plate and minus 16- $\frac{1}{2}$ volts on the grid as under these conditions it will deliver practically the same undistorted output as would be gotten from a UX-120 or UX-112 with a plate voltage of 135. This means a considerable saving in B battery space, weight and first cost. Used in this way it can easily be applied to a large number of sets now employing the 201A tube.

Proper grid biases are as follows: 40.5 for 180 volts plate, 27 for 135 volts plate and 16.5 for 90 volts plate.

Incidentally—this tube looks better for the "one mouse power" sending sets than do the usual receiving tubes, although the UX-210 is really the tube for that job. It's a pity that the filament of the UX-210 cannot be operated at full brilliancy from a 6 volt source. Of course it does not matter if one is intending to use a plate voltage much below the rated one; under those circumstances the output will be just as great with 6 volts on the filament and the tube will last for years and years.

—R. S. K.

THE 874 REGULATOR TUBE

The UX-874 regulator tube is a curious animal. It hasn't any filament and its only business in the world is to use up power. That sounds like a senseless sort of a tube—but wait!

If a filter system is connected up as shown in the figure 1 the voltage at the output will be almost anything, depending on the load. That is one of the things that has made it hard to get up satisfactory B-battery substitutes. If one used a 2-tube receiver on the things the voltage would run up too far and if one used an 8-tube set the voltage went down too low. One way out was to use taps on the primary of the transformer but that isn't automatic.

Now suppose that we had an arrangement like that of Fig. 2 where the load "X" was of some curious sort that would always take anything necessary to keep the voltage at the 90 volt tap just right. For instance if the rectifier supplied 50 milliamperes this tube would let the receiving set have what it wanted—and then would "soak up" the rest of the 50 milliamperes. That is exactly what the 874 tube does, although the explanation may be a bit crude.

The Method of Operation

The tube contains a cylindrical plate and a point. When voltage is connected to the



FIG. 1

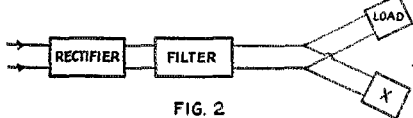

FIG. 2

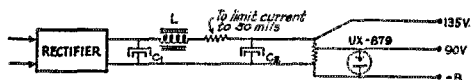

FIG. 3

FIG. 1—A FILTER SYSTEM THAT REGULATES BADLY
FIG. 2—A SPLIT-LOAD SYSTEM TO IMPROVE THE REGULATION
FIG. 3—THE SPLIT-LOAD SYSTEM APPLIED TO THE 874 TUBE. THIS IS THE SCHEME OF THE R.C. DUO-RECTRON

tube (positive to the point) nothing happens until 125 volts is reached. Then the tube breaks down and the voltage across it drops to approximately 90. The current through the tube can then be varied from 50 milliamperes to 10 mils or so and the voltage across the 874 will change only about 3 volts. When watching the tube one will see that the amount of plate surface covered by the glow discharge changes with the amount of current and when the entire surface has been used up (at about 50 mils.) the voltage will rise again. This is the limit of the regulating-range of the tube. The other limit is the one at which the tube goes out from lack of current.

Now one can see that this thing works like a Heising modulation system, the total current from the rectifier stays at 50 milliamperes and divides one way or another between the load and the UX-874. Just how it divides depends on the load—but the 874 keeps the total current the same and therefore the voltage always the same.

The Tube as a Filter

The oddest part of all is that the tube acts as a filter by passing through any

A. C. ripples that may have gotten past the regular condenser-and-choke filter.

The Tube as an Oscillator

The writer amused himself with the quite useless game of seeing if the tube could be made to oscillate. This seemed plausible as the affair is equipped with I/E characteristics reminiscent of the arc lamp. It was found perfectly possible to make the affair oscillate at 200 meters—with all the usual "hash" that is expected of an arc. That was enuf. The 874 is a poor arc—but a beautiful regulator.

—R. S. K.

New Condensers

A VERY sturdy and rigid variable condenser having several unusual features is shown in the illustration. The frame is a single die-cast job. Cone brass bearings are provided for both front and rear supports. The plates are brass, acid-dipped and treated to prevent tarnishing. Either single hole or double hole panel mounting can be used, or the condenser can be mounted directly on a baseboard. By means of the hollow end shaft these condensers can be ganged, as many being operated from a single control as is desirable. They are available in several maximum capacities and either straight wavelength or straight frequency line.

The small condenser is a vernier affair, intended either for balancing, neutralizing or compensating or for use as a small an-

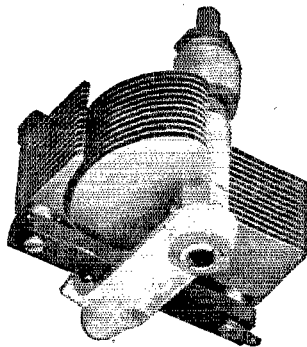
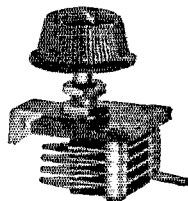

tenna series condenser. The end piece is bakelite, the plates are of brass and either single hole panel or sub-base mounting can be had. Both of these condensers are made by Silver-Marshall in Chicago.

—J. M. C.

PRR

By A. L. Budlong*

Every winter in the United States there is at least one blizzard and sleet storm which demoralizes wire communication. The A. R. R. L. has been called upon several times in recent years to supply emergency communication for railroads during such tie-ups, and is very proud of its ability to have served them. Here is a story of an organization created for the servicing of one railroad. Although fortunately no terrible storm occurred, the system was ready for it, and in its training it brought back to its members the good old relaying days that were.—Editor.

TO THOSE who in late months have grumbled that the relay game isn't what is used to be, and to those who have sworn to high heaven that the average ham station isn't interested in anything but DX, the following tale is told.

On January 16th of this year the Pennsylvania Railroad asked the A. R. R. L. to give it a railroad emergency service similar to that furnished two years ago. They wanted that service to start on January 18—two days later—and continue for the following ten weeks. They wanted some thirty-one points in the three Regions of their system covered, and they also wanted to conduct periodic tests over the system with messages starting from each of the three Regional headquarters to outlying points—these messages and answers to them to be delivered within a matter of a few hours at most.

Eighty-odd amateurs in the third, eighth and ninth districts have just finished putting over that emergency service, and with the last test on March 23 they finished a job that will stand long in the annals of amateur work as an outstanding piece of amateur achievement.

Now here's the remarkable thing about it all: That service was a hard job—ten weeks of it. Those eighty fellows gave up their time and a lot of their sleep. They stood watches on tests until they had to prop their eyes open. They strained their ears for signals just too weak to read through QRM and QRN. They sweated and cursed, and often got very, very tired. They did all this knowing that there was no reward in it, no prizes and no individual glorification. But along with the last reports sent in they all said, "That was the greatest piece of amateur relay work I ever did. DX can't begin to compare with it. No matter what else happens, we absolutely *must* have some more 'PRR'."

What could be a more utterly effective answer to those who are bewailing the passing of the old relay interest!

This article is not for the purpose of proving that the relay interest is still very much alive. Instead, it is written to chronicle the

splendid work that the "PRR Gang" did during those ten weeks.

The heart of the whole job was the official tests—usually held weekly—and it is to them we must turn to get an idea of what was done. Take a look at the map. You will notice that there are some thirty-one cities indicated. These cities comprise the emergency net which the Pennsylvania Railroad wished covered by amateur radio, and in all but two instances one or more stations were appointed in each city to act as emergency stations. Now, you will also notice that the cities are assigned to Regions, and that there are three of these Regions—the Eastern, with Philadelphia as the headquarters city; the Central, with Pittsburgh as headquarters; and the Western, with Chicago as the headquarters.

These three regions operated more or less independently of each other, but since all were operated along the same lines, a description of what happened in one is a fair picture of what happened in the others. The weekly official tests already mentioned were run substantially as follows: The amateur station or stations in the headquarters city for the particular region was given messages for some or all of the outlying cities in that Region (and quite often one or more messages for points in one or both of the other regions). These messages were started from the headquarters city at a pre-arranged time each week, and had to be delivered by amateur radio to the outlying points, telephoned in to the Pennsylvania R. R. offices at that point, an answer received, and relayed back to the headquarters city. All this had to be done during the same day the messages started.

From five to twelve messages were started from each headquarters city each week, the average number for the whole ten weeks period being 9.3 messages started per region, or, counting answers, 18.6 messages handled per test per region. To get eighteen messages passed around an entire region, with relays, telephone calls, etc., in a matter of part of a day is pretty good work, but in actual practice it worked out even better than that.

For instance, on March 1 the Eastern

* In charge, PRR Emergency Work.

Region had messages for eight points in its own region, and also messages for Pittsburgh and Chicago in the Central and Western Regions, respectfully. *All ten messages were delivered, phoned in, all the answers secured and relayed back to Philadelphia within TWO HOURS after the test started!*

Another example is furnished by the Central Region, where there were nearly a dozen instances of messages being handled, including answers, in less than fifteen minutes; several messages (answers counted of course) hung up times of ten minutes, and there are three instances where they were even less than ten minutes—the record being five minutes.

And those weren't easy messages either! Practically every message handled contained code, and some of the checks ran as high as 70 and 80!

Now for a few statistics: There were a total of 317 messages handled in all three regions during the tests, and of these 275 were delivered, making an all-round delivery percentage of 86.8%. A total of 19 official tests were held, of which 9 were 100% successful (that is, all messages and all answers delivered). Of the remaining 10 tests, five were 80% successful or better; three were 70% or better, and the remaining two were about 40% successful.

The Eastern Region had 5 official tests, of which 4 were 100%—the remaining one being 80%. The Central Region had 9 official tests, of which 5 were 100%, the other four ranging from 92.8% to 71.5% perfect.

The Western Region had 6 official tests, of which one is a profound mystery known only to the Western Region and the writer of this article. (How about it Western—hi!) Of the other 5, none was 100%, the results ranging from 83.3% to 37.2%. This should not be held against the Western Region, however, because to the end of the tests there were two points for which messages were destined each time, but in which there were no stations to handle traffic. Were it not for this fact, two of the Western Region's tests would have been 100%, and the average of the remainder would have been about 75%. The fellows in the Western Region worked just as hard as the other two, and where there were stations they usually delivered, but, as heretofore stated, it happened that in every test they had messages for points where there were no stations, consequently this pulled down their average in spite of hard work. Tough luck!

It is unfortunate that in an article which is as short as this one must be, many of the high lights and interesting details which occurred must be left out. For instance, it is

impossible to reproduce here the letters that every week piled in from the "gang" and to print the enthusiastic comments that accompanied each letter. It is impossible to portray the tremendous difficulties that the Eastern Region had to overcome in order to get those 100% tests. For three weeks before the official tests started the whole region worked day and night trying to find out what waves would carry more than a few miles from the transmitters, and after it was found that forty meters was useless, practically every member of the region voluntarily tore down his forty-meter installation and made it over into an eighty-meter set. It is likewise impossible to put into words the spirit that prompted 8CEO and 8BRC to stick out a twelve-hour watch trying to get a message to Erie on the March 14 test.

Typical of the spirit shown, too, were the performances of many of the operators who never had a chance to handle traffic, but who stood on their watches on each test for the full length of time to be on hand in case of a break-down along one of the regular lanes of communication. To these fellows especially goes a large share of the credit, for it takes real cooperative spirit to "stand by" hour-after-hour while other more fortunate operators are handling the traffic.

As this article is written, the tests are officially at an end, but the spirit of the "famous 80" is such that it is probable something else will be cooked up to sup-

DATE	EASTERN REGION	CENTRAL REGION	WESTERN REGION
JAN. 24	<i>Organization in all three Regions</i>		
JAN. 31	<i>no test</i>	$\frac{9}{14}$ 57.1%	<i>no test</i>
FEB. 7	<i>no test</i>	$\frac{20}{24}$ 83.3%	<i>no test</i>
FEB. 14	<i>no test</i>	$\frac{12}{14}$ 85.7%	$\frac{10}{22}$ 45.4%
FEB. 21	$\frac{8}{10}$ 80%	$\frac{14}{14}$ 100.0%	$\frac{14}{18}$ 77.8%
FEB. 28	<i>no test</i>	$\frac{10}{10}$ 100.0%	<i>no test</i>
MAR. 7	$\frac{10}{10}$ 100.0%	$\frac{16}{16}$ 100.0%	<i>Mystery!!! - Hi!</i>
MAR. 14	$\frac{18}{18}$ 100.0%	$\frac{13}{14}$ 92.9%	$\frac{4}{11}$ 37.0%
MAR. 21	$\frac{20}{20}$ 100.0%	$\frac{22}{22}$ 100.0%	$\frac{10}{12}$ 83.3%
MAR. 28	$\frac{20}{20}$ 100.0%	$\frac{18}{18}$ 100.0%	$\frac{14}{20}$ 70.0%

NOTE: "No test" means no official test. Unofficial tests were usually held at these times, however.

plant "PRR" during the summer months, so that the good work may go on. During the period of the tests a weekly mimeographed bulletin, "PRR News," was sent to each member of the gang, and the "printer" was in for a good razzing if, as on several

occasions, the publication was late. Should the organization be kept up, as it has

9BEQ, 9TT, 9PW, 9OX, 8BN, 9CUR, 9CYQ, 8ANB, 9CLO and 8LO.

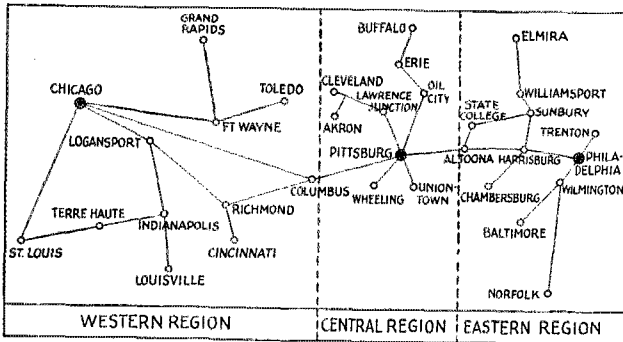

There they are, and it is through suchwork as these fellows have just completed that the prestige of amateur radio and the A. R. R. L. is enhanced. Long after the amateur world has forgotten who was responsible for the first Greenland-Timuctoo QSO it will remember "PRR" and the cooperation and hard work on the part of the fellows who have woven into those three letters a tradition of "Service"—a service which was not rendered for personal gain and which received none, but which found its own reward in a job well done.

every appearance of being, the "News" will be an important cog in the machinery.

To give a graphic presentation of the entire ten weeks' work, a chart is reproduced herewith showing what happened each week in each Region. All tests recorded are official tests—that is, the messages were official communications emanating from the Pennsylvania R. R. offices. The percentages shown are the percentages of delivery (counting answers) with the exception of the March 14 test in the Western Region, where no answers were required. The other figures in each box indicate the number of messages to be delivered, and the number delivered. 8/10, for instance, means that eight out of ten messages got through; 10/10 indicates 100% delivery.

The following stations participated in the tests, according to the files here at headquarters:

Eastern Region: In charge of 3ADB. Also, 3CAH, 3CKJ, 3DH, 3CBT, 8HJ, 3BSS, 3CGC, 3CBX, 3TI, 3CKA, 3BNE, 8BSZ, 3ADE, 8XE, 3FU, 8BES, 8BFE, 8EU, 8VW and 8AKI.

Central Region: In charge of 8AGO. Also, 8VE, 8CEO, 8EW, 8JQ, 8BIT, 8ARC, 8BRM, 8DHB, 8DKS, 8HM, 8ABS, 8BSU, 8CDV, 8AUL, 8DOH, 8BRC, 8GL, 8CGF, 8BPL, 8BNH, 8BTH, 8ES, 8DIA, 8GU, 8BDJ, 8BVK, 8ADA, 8ACR, 8QB, 8RV, and 8AYT.

Western Region: In charge of 9ZA until he had to go East on business; afterward in charge of 9APY and 9QD. Also, 9DWH, 9CYR, 9IX, 9AIO, 9BR, 9DLB, 9MN, 9BHI, 9ZK, 9CMJ, 9EJI, 9DUC, 8ZG, 8BYN, 8BAU, 8AVX, 8BIQ, 9BKJ 9DPJ, 9DMJ, 9DOE,

A Low-Power Transmitter Kit

SINCE our article in the April issue on "Breaking into Amateur Transmission", the Radio Engineering Laboratories of New York City has placed on the market a complete kit of parts for the transmitter. A photograph of the kit, assembled, is shown herewith. The kit includes primary and secondary inductances on glass spacers, two long glass support rods for the inductances, primary and secondary variable condensers, socket, grid leak, rheostat, in fact everything needed to assemble a duplicate of the April QST transmitter. The panel and baseboard are of hardwood. The panel

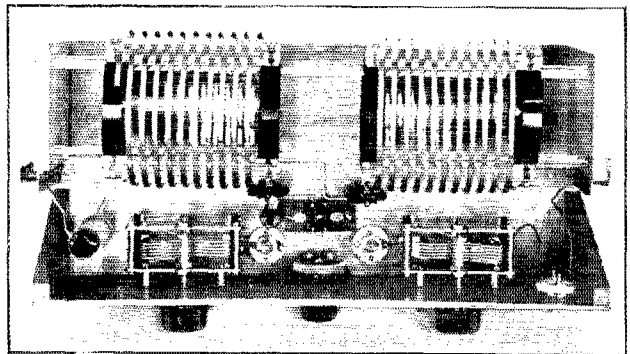

is neatly engraved as are the two hard rubber terminal strips. A person desirous of "becoming a telegraphic amateur" can find no easier way of "breaking-in" than by purchasing a kit such as this one.

—J. M. C.

Progress of the Wilkins Expedition

Mason and Waskey Carrying On Under Difficulties

News Now Coming By Radio

IN OUR MARCH issue we told of the prominent part that amateur radio again is playing in an Arctic exploration party, this time the Detroit Arctic Expedition under the leadership of Capt. George H. Wilkins. The radio operators are Howard F. Mason, 7BU, and Robert Waskey, 7UU, both A.R.R.L. members from Seattle. For details and a description of the apparatus our readers are referred to our March article.

All of the personnel and equipment, including two Fokker monoplanes, were safely assembled at Fairbanks, Alaska, the railhead. From there an advance party set out overland with a snow-sled caravan, transporting airplane gasoline and the old NRRL set to establish the base at Point Barrow, hopping-off place for the aerial exploration of the unknown Arctic region. With this party went Mason, chief operator, also carrying a portable battery-operated set which he built, signing KFZH, for communication back to Fairbanks. At Tolovana, sixty miles out, the snow motors were abandoned because it was discovered that fuel was being consumed so rapidly that they would arrive at Barrow without surplus for the planes. Five dog-sledges were substituted for the motor-sleds and the party again started on its 1000-mile overland trip. Mason returned to Fairbanks at this time and Waskey replaced him as operator for the overland party. The party consists of Malcolm ("Sandy") Smith, leader; Earl Rossman, photographer and correspondent; Waskey, and drivers. At this writing the party is well over the summit of the Endicott Mountains and on its way to the shore. There the 200-watt KFZG station (ex-NRRL) will be established, with DC supply from a gas-engine-driven generator, working on wavelengths of 24, 35.5 and 73 meters. As the sledge expedition progressed, it was in touch at camp each night with the base at Fairbanks. Waskey using the little battery operated set which Mason built, and Mason at Fairbanks using the Burgess-built portable set which was described in our March issue. In this way news has come down daily, so far coming via wire from Fairbanks.

The main party at Fairbanks has been visited by accident and tragedy. Palmer Hutchinson, famous correspondent and representative of the North American Newspaper Alliance, was killed there by an aeroplane propeller in tests of the "ships." Earp, a "Seattle Times" man,

has now joined Wilkins in his stead. The small single-engined Fokker plane, designed to freight gas and equipment by air to Point Barrow, broke off its landing gear in landing in the snow after a trial flight, but has now been repaired and at this writing is ready to start gasoline flights to Barrow. The big three-engined Fokker also washed out its landing gear and will be unserviceable until rush repair parts are received. This big Fokker is equipped with a short-wave crystal-controlled transmitter built by Malcom P. Hanson of Washington, a 50-watt tube operated at 400 volts from a wind-driven generator.

As soon as the big Fokker is repaired, Capt. Wilkins plans to fly to Barrow, stop for a few hours, and immediately take off for the Arctic. On his return he will fly back to Fairbanks, pick up Mason and the Burgess set, load both planes with gas from Tolovana, and fly back to Barrow, from which point further explorations will then be conducted.

Mason reports very extraordinary and changeable radio conditions on amateur waves in Alaska this year. After Mason goes to Barrow, the Fairbanks end of the communication will be handled by Lieut. Messer, in charge of the Signal Corps station there; Mr. Clark of 7GZ, and Leon C. Grove at Nenana. Mason reports had receiving interference throuth that country from electric pumps. Everyone has his own well in his back yard, equipped with little automatic pumping outfits, and when they break loose QRM is fierce. On Saturday night, "bath night" in particular, it is almost impossible to do anything. Newspaper headline: "Saturday Night Baths Interfere With Radio." Hi!

Headquarters requests that all hands keep an ear open for our buddies of the Northwestern Division, and advise the Communications Manager of any contact or reception.

—K. B. W.

Strays

Richard Brackett tells us that a high speed drill (costing not very much more than the ordinary twist drill) can be used to drill through the Pyrex custard cups in fine style. The drills can even be used until they are red hot and then continue to do their stuff. Use plenty of turpentine and you can go through Pyrex as easily as brass.

How to Check Radio Messages

Announcement of a Change in A. R. R. L. Relaying Practise

EVER since Morse perfected his electric telegraph, operators have sent messages from point to point using dot and dash code groups. Various message forms and operating practises have been adopted by different organizations to simplify transmission and to "check" transmitted matter for *accuracy* and *completeness*. In commercial work, the check is useful in addition to determine the charge for sending the message.

For many years, the American Radio Relay League has followed land-line telegraph practices wherever the counting or checking of messages was concerned. This was in view of the fact that our message service was mainly a land service. The conditions governing were somewhat similar to those under which the existing land telegraph companies were operating.

The past ten years have been substantial developments in short wave work. With the growth of our organization, our problems have gotten bigger and broader. Our communication work has expanded until today international two-way radio contact is commonplace; radio conversations occur daily with the Antipodes; thousands of words of traffic from expeditions in the Arctic sent to the press and to friends at home all come by short waves "via amateur radio".

An increasingly large number of ARRL members are interested in preparing themselves for radio operating and radio engineering positions. To meet all these changed conditions our ARRL Board of Directors has adopted standard radio cable count for checking our messages.

A. R. R. L. Messages

Almost every member knows and uses our A.R.R.L. message form. Our radio messages contain a *city or origin, station of origin, number, date, check, address, text and signature* in the order mentioned. All this information should be included in a message to insure that it gets through to its destination safely. The information contained in the preamble tells the recipient how quickly the message travelled as well as from what station it originated. This information makes it possible to correctly route an answer or a service message explaining non-delivery or delay.

Every commercial message *must* carry a check. All important amateur messages should also be checked. *Accuracy* is very

important and the check should never be neglected when a message has any value.

Filing Messages

Operators originating messages should assist the sender as much as possible to avoid errors and delays. Misspelled words, and unnecessary punctuation marks should be changed with the consent of the sender. The importance of a sufficiently complete address should be particularly stressed to insure delivery. After the message is filed, no changes by the operator are permitted. Words must be transmitted in full in every sort of a message except a service message where abbreviations are in order.

Counting of Words—Cable Count

Every word in the *address, text, and signature* of a message counts in the check when we use cable-count. Words and abbreviations in the preamble are not counted.

In the ADDRESS, the names of cities, states, countries or other divisions of territory *each* count as one word regardless of the number of letters they contain. Proper names in the address and signatures are counted at the rate of one word for each 15 letters or fraction thereof. The words street, avenue, square or road are always to be counted each as one word separately from the name of the street, etc., whether written with it or separately. Names of ships are counted as one word irrespective of the number of letters they contain. When there are two ships of the same name, the name and the call letters of the ship are together counted as one word. The name of the state is always counted as one word in addition to the name of the city. Initials in the address are counted each as one word. Each *group* of house or street numbers is allowed to pass as one word, however, if a telephone number is included in the address, the word TELEPHONE or PHONE counts as one word. The name of the exchange is an additional word in the check. Each group of five figures or fraction thereof counts as one word. A hyphen indicating the word "ring" may be substituted for one figure in a telephone number without increasing the check. PHONE CHARTER 328-5 counts as 3 in the check. 26039 counts as 1 in the check. 2603-9 is a six character group and accordingly counts as 2 in the check.

Radio calls are often included in the address to make proper routing easy. 5XAY

2—Every ARRL station starts a new series of numbers January 1 each year. Each message *originated* is assigned a number in the sequence originated. See "Numbering Messages," page 1 Traffic Department Section December, 1925, QST.

1—The service message was fully explained on page 1 of the Traffic Department section of September, 1925, QST.

counts as one word in the address but as four words when it appears in the body of the message (see the example in the message shown above).

In the TEXT words are counted for every fifteen characters or fraction thereof if the message is a *plain language* message. A word containing from 16 to 30 letters counts "2" in the check. As English is the business language of the world, most languages are sent in English. Messages *can* be sent in any language made up of the Arabic (26-letter) alphabet.

Names of cities in the address count as one word while in the text they may count as more than one word. "New York City" counts as *one* word in the address but as *three* words wherever it appears in the body of the message. Isolated characters each count as one word. Five figures or less in a group count as one word. Words joined by a hyphen or apostrophe count as separate words. A hyphen or apostrophe each counts as one word. However, they are seldom transmitted. Two quotation marks or parenthesis signs count as one word. Punctuation is *never* sent in radio messages except at the express *command* of the sender. Even then, it is preferably spelled out. In the text of messages, the names of ships are counted at the rate of 15 letters to a word if the names are written out separately. If all parts are joined to form one word each 10 letters or fractional part counts as one word.

Messages may be classed as *plain language* messages, *coded* messages or *cipher* messages. A plain language message bears the same thought indicated by the dictionary meaning of the words used in the text. All ordinary messages are plain language messages. Every 15 characters or fraction thereof, counts as one word. Numerals are counted in groups of five or less.

In coded messages, the words are all pronounceable but their arrangement is not necessarily in sentences to express the thought. Several selected words or word groups express more extensive thoughts. In code messages, every ten characters or less counts as one word. Either dictionary or artificial words may be used but all words must be pronounceable to take the ten letter count. Words containing 11 to 20 letters count "2" in the check. When one has a copy of the simple and commonly-used codes, the business of coding and decoding is easy.

In cipher messages, the letters or figures in each uninterrupted series are counted at the rate of 5 (or fraction thereof) per word. Groups of letters are checked at the same rate as groups of figures. Mixed letter and figure combinations must be counted differently. R4TG counts as four words unless it is an *established* trade mark or trade name. Radio calls are always counted as

cipher. 1MK counts as *three* words in the address or text of a message. For accuracy it should be written "one mike king". Abbreviated or misspelled words are counted at the "5 letter" rate in any message where they accidentally appear.

If a message is written partly in plain language partly in cipher, and partly coded, the words in plain language are counted at the "15 letter" rate while the other parts of the message are checked at the "5 letter" and "10 letter" rate respectively.

Either whole or fractional numbers, spelled out so each group forms a continuous word, may be checked at the "15 letter" rate. FOB, COD, SS, ARRL, QST, and such expressions in current use are counted five letters to a word wherever they appear. Groups of letters are not acceptable in the address but must be separated and checked as one word *each*.

Here is an example of "plain language" message in correct ARRL form and carrying the "cable count" check:

(HR MSG FM HARTFORD CONN
1MK NR 85 217P MAY 3, CK 51)
(to) H W. DENSHAM

140 WASHINGTON ST
COLLINGSWOOD NEW JERSEY
PLEASE COMMENT ON PROPOSED
OLD TIMERS WEEK USING 175
METER WAVELENGTH STOP BACK
NUMBER OF QST YOU WANTED
WAS FORWARDED MONDAY STOP
WHAT WAVELENGTH IS MOST IN
USE AT 3EH QUESTION 73 TO YOU
AND NEW JERSEY GANG.

(Sig) A.R.R.L. COMMUNICATIONS
MANAGER.

The count on each part of the message is added to give the "check" shown. Address: 8. Text: 40: Signature: 3. The check is the sum of these three or 51 words. The parts of the message in parentheses are always transmitted but do *not* count in the check.

The following words that give most trouble in counting this message add into the "check" as follows:

H—1
W—1
140—1
ST—1
NJ—1
175—1
QST—1
3EH—3
73—1

A.R.R.L.—1
New Jersey—2

This change in the method of checking our messages is effective at once *Please put it into practice immediately*. Make a copy of the rules to follow in counting words and stick it in on the station wall or under the desk blotter for ready reference. Start

your messages with a correct check so they will get through accurately. Check messages you receive by these rules. Explain the proper method of checking to the transmitting operator if he shows lack of understanding on the subject.

—F. E. H.

A New S.F.L. Condenser

KEEPING in line with the development of straight frequency line condensers, the National Company of Cambridge, Mass., has brought out a condenser of this type, having several very novel features. The capacity is varied from minimum to maximum by a 270 degree rotation of the shaft in contrast to the usual 180 degree movement. This fact coupled with the straight frequency line characteristics tends to make the tuning scale much more spread out and open throughout its entirety. Stations operating with equally spaced frequencies will be spaced apart equally on the tuning scale.

The plates and end frames of the new condenser are of aluminum. The stator plates look like plates in the ordinary type of condenser except that they are cut on a much wider radius and look as tho they had been cut half in two. The rotary plates have the characteristic "off center" shape.

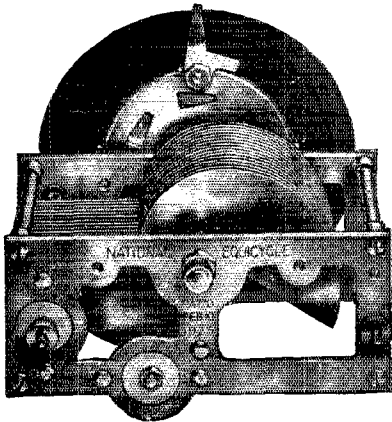

The insulation in the Equicycle condenser is Isolantite. Four circular pieces placed in a position where the field is weakest serve to support and insulate the stator plates.

The condensers are supplied in two sizes: 250 μ fd. maximum with a 9 μ fd. minimum, and 500 μ fd. maximum with a 11 μ fd. minimum. With a coil having low distributed capacity the 250 μ fd. size will cover the band between 200 and 590 meters (1,500 and 508 k.c.)

—J. M. C.

1XM Schedules

1 XM, the station of the Massachusetts Institute of Technology Radio Society, acting in coöperation with M.I.T. Communications Laboratory, advises that it will transmit on the following schedule for the month of May:

Schedule of Frequencies in Kilocycles

(Approximate wavelength in meters in parentheses)

Time P.M.E.S.T.	Schedule A	Schedule B	Schedule C
9.00-9.07	16000 (18.7)	9072 (33.1)	16130 (18.6)
9.11-9.18	15000 (20.0)	8820 (34.0)	15620 (19.2)
9.22-9.29	14000 (21.4)	8586 (35.0)	15120 (19.8)
9.33-9.40	8500 (35.3)	8316 (36.1)	14620 (20.5)
9.44-9.51	8000 (37.5)	8064 (37.2)	14110 (21.2)
9.55-10.02	7500 (40.0)	7812 (38.4)	5710 (52.5)*
10.06-10.13	7000 (42.8)	7560 (39.7)	4032 (74.4)
10.17-10.24	6500 (46.1)	7308 (41.0)	3900 (76.9)*
10.28-10.33	4000 (75.0)	7056 (42.5)	3780 (79.3)
10.39-10.46	3750 (80.0)	6804 (44.0)	3600 (83.3)*
10.50-10.56	3500 (85.7)	6552 (45.8)	3528 (85.0)

11.05 A R R L Broadcast at 7500 k.c. (40 meters)

Dates of Schedules

Friday May 7	Schedule B
Friday May 14	A
Friday May 21	C
Friday May 28	A

Time Division

Each frequency occupies 7 minutes in the schedule. The time is divided as follows.

3 Minutes "QST QST QST U 1XM 1XM 1XM" etc

3 minutes long dashes broken by "1XM"

1 minute, announcement of exact frequency.

Accuracy

Schedule A about 1/10 of 1%.

Schedule B about 2/100 of 1%.

Schedule C about 2/100 of 1%. except

the points marked with an asterisk (*) which will be accurate to about 1/10 of 1%.

In all of the schedules the actual frequency sent may be slightly different from that shown in the table but the exact frequency will be announced in the last minute of each 7-minute period.

Suggestions. Suggestions for improving the service will always be appreciated provided that you ask no more than you would be willing to do *regularly* yourself. The man who has not done this sort of work seldom understands the very great amount of work involved. Please send suggestions to K. V. R. Lansingh, 2ATF, of the OWLS Committee, 226 Elderdown Avenue, Pelham, New York.

Grasshopper Radio

By M. Adaire Garmhausen*

WOTTA Life!

We are not one to cry our father out of a grand piano just because the girl next door has one, but in this radio business you have to keep up with the gang.

It all started in the school days when the fellow with the loose coupler a yard long led the parade and "coherer" was a word often mentioned. That good-looking Schaeffer boy was the most prominent figure in the class. He had a princely bearing, which was quite in place, for did he not have a "Commercial First"—and had he not seen actual service on a Tampa oil tanker or something equally grand and noble? As we said before, he was frightfully good-looking, so when he came and sat down by us we smiled very timidly and ventured—"Have you a receiving set?"

His Highness smiled with amused tolerance. "I," he replied with lordly air, "I have an audion cabinet."

"Oh," said we in a very small voice—not knowing in the least what an audion cabinet might be.

It was John Louis who explained it to us and added that it was the only one in town. We resolved to have an audion cabinet and be one of the 400. Nothing but the very last gasp in radio would do for us. After that we lived in a trance for a long time, measured only by the clinking of nickles and dimes in our toy bank. We kept our own counsel until the great cabinet arrived, and a beautiful sight it was—a long, narrow rosewood case with nice white porcelain rheostats and two precious audions mounted on the panel.

We strolled into class and nonchalantly announced that we had an audion cabinet.

The anticipated acclaim was not forthcoming; they only asked what kind it was. We started to describe the treasure and watched the interest fade from the faces round about.

"Dear me," we heard, "nobody mounts the tubes on the front of the panel any more. They should go inside."

NOBODY! Here was the town full of audion sets—all of a pattern later than our own. That was not all. Our flat-top aerial was passé and everybody was pulling hard for squirrel cages.

We glimpsed the shadow of the approaching basket-weave coil—we hastened to possess ourselves of a 3-circuit regenerative

receiver plus two steps all securely housed with the wiring out of sight per latest trend. Transmitters were again being tolerated and we started right out with a 10-watt set—C.W. on 200 meters flat.

The popular favor skipped lightly over the basket-weaves and seized upon honeycombs instead, but we were still well enough established until someone started to explore the 100-meter wave. The crowd followed and left our 175-360 tuner high and dry. Not only that—they went on down to 80 meters.

Something had to be done at once. The prevailing mode was to assemble one's own sets so we ordered one of the kits and got to work. What we did with that soldering copper and several pounds of copper was fearful but finally we got some sort of order out of the chaos. We had been smart too; we had put one over on them; we had headed them off and produced a set that tuned down to 40 meters. Oddly enough the set worked and with a satisfied smile we tuned around for our old friends—but they were all down on 20 meters and accordingly out of our range.

That's the way it goes. Like Alice and the Red Queen you must keep running as hard as you can just to stay in the same place. Single wires have now replaced the squirrel cages. Goodness knows what has replaced the other equipment. 3BCK has been slumbering peacefully for 6 months now, waiting for a slight halt somewhere.

We hope to dive in again—but when we do someone will move the ocean and we will be left sticking head-first in the mud. That is why we remarked in the first place—"Wotta life."

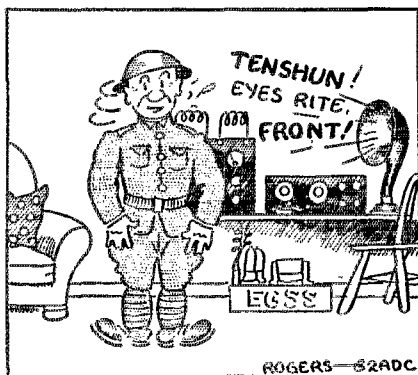

DRILL NIGHT AT AN ARMY AMATEUR RADIO STATION

* 3BCK, 516 West 27th Street, Baltimore, Maryland.

Adjusting the Crystal-Controlled Transmitter

By Stanley P. McMinn*

THERE is nothing particularly tricky about getting a crystal-controlled set in operation provided one has a fair smattering of radio knowledge, and will proceed with the various adjustments in a systematic order. Once the different parts of the set have been made to function properly it is comparatively easy to get them to operate together and to place crystal-controlled power in the antenna.

The more or less standard crystal circuit is shown in Fig. 1. This is the circuit used at 2WC with a single UX-210 as the crystal oscillator and two 203-A's as power amplifiers. The first thing to do is to get the oscillator going. The inductance L should be constructed along the usual low-loss lines, and all leads in the oscillator circuit should be as heavy and short as possible. Do not use more than 350 volts on the plate of the oscillator tube; 300 to 325 volts are better as the higher voltages are likely to cause the crystal to vibrate too strongly and give out a singing note audible to the ear and modulating the oscillator output at about 1,000 cycles. A voltage much above 350 is liable to heat the crystal or cause it to fracture or chip.¹

After the crystal oscillator circuit has been built up, carefully adjust the tuning condenser across the inductance L until oscillation is indicated by a large jump on the part of the ammeter A. As soon as the crystal and tube are oscillating, adjust condenser C until maximum current in the closed circuit is obtained with minimum plate current.

Leave this adjustment as it is and closely couple the antenna inductance L₂ to the oscillator inductance L. Tune the antenna circuit resonance with the oscillator by noting the point of maximum deflection on the antenna ammeter A₁. It is advisable to proceed in this fashion so that when the power amplifier is being adjusted the antenna will be there to absorb at least some of the energy, and the power amplifier tubes will not have to soak up power in useless plate dissipation. Incidentally this keeps the power amplifier tube plates from becoming so hot they almost drip!

The antenna and counterpoise are discon-

nected from the inductance, and the antenna coupling coil is coupled to the plate inductance of the power amplifier tubes, all the while leaving the clips on the antenna coil L₂ and the antenna series condenser C₂ set as they were when the antenna circuit was tuned to the crystal oscillator's wavelength. The antenna and counterpoise are reconnected to the coupling coil. The antenna circuit will then be tuned approximately to

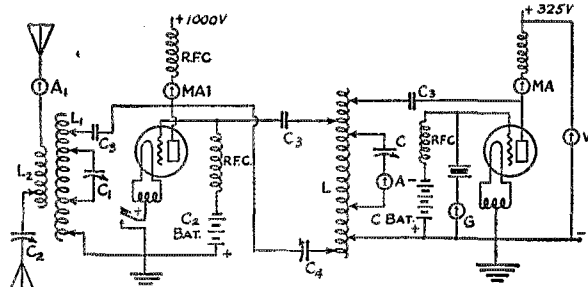

FIG. 1

- L—10 turns of R.C.A. inductance.
- L1—Ditto.
- L2—4 turns ditto.
- RFC—200 turns No. 36 D.C.C. wire on quarter inch wooden dowel.
- C—500 uufd.
- C1—250 uufd.
- C2—430 uufd.
- C3—2,000 uufd.
- C4—Normally 250 uufd. but double spaced.
- G—0-100 milliamperes thermogalvanometer.
- A—0-3 ampere thermoammeter.
- A1—Ditto.
- MA—0-100 milliamperes, D.C.
- MA1—0-500 milliamperes, D.C.
- V—0-15 volts, A.C.
- C-BAT 22½ to 30 volts.
- C2-Bat 90 volts.
- X—Key.

the power amplifier's wave when the latter has been adjusted properly.

Now place the power amplifier grid tap at a point on the oscillator inductance L, about two turns from the plate clip. You are then ready to adjust the neutralizing condenser C₄. The amplifier must be neutralized or there will be a chance of regeneration in the amplifier circuit.² If this happens there may be sufficient feedback into the crystal to wreck it. Turn on the fila-

1—There is some evidence that the crystals actually "tire" and cease to function at all, if excessive plate voltage is used over a long period of time. They shimmy themselves to death.—Asst. Tech. Ed.

*2WC, and Editor, Automotive Merchandising, 1832 East 5th Street, Brooklyn, N. Y.

2—Unless the oscillator and amplifier circuits are isolated much more than they are at 2WC there is probably a lot of regeneration present in the amplifier circuit at all times. When this regeneration gets excessively great, the crystal may "plop" and crack or chip or even explode.—Asst. Tech. Ed.

ment supply for both oscillator and power amplifier tubes and put the plate voltage on the oscillator tube but not on the power amplifier. Carefully adjust the neutralizing

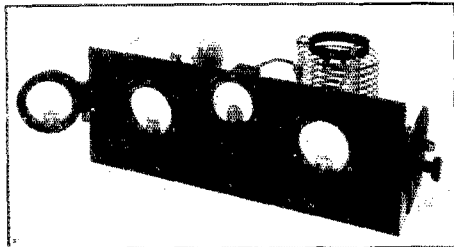

NEW CRYSTAL OSCILLATOR AT 2WC

condenser (C4) until you get practically no movement of the plate circuit milliammeter MA when you vary the tuning condenser in the amplifier plate circuit (C1).

You will probably never get the neutralizing condenser adjusted so that a movement of the power amplifier tuning condenser will cause *no change* in current in MA, but adjust for minimum movement of this meter. When you have secured this adjustment let the neutralizing condenser alone and re-adjust the oscillator condenser C for maximum current in the ammeter A with minimum plate current. This, in turn, will require further adjustment of the neutralizing condenser as these two adjustments are more or less inter-locking and a change in one will cause a corresponding change in the other. Adjust the two circuits until you secure maximum current in the closed circuit of the oscillator with minimum plate current, and at the same time practically no movement of the oscillator milliammeter when you swing condenser C1 in the amplifier circuit.

Next, the plate voltage is placed on the amplifier tubes. Keep this voltage low at first, until the power amplifier has been tuned. Carefully adjust the clips on L2 and the condenser C1 until the amplifier hits resonance with crystal oscillator. When this happens the antenna ammeter A1 will show current because the antenna circuit has previously been tuned to the oscillator's wave. The amplifier tuning condenser and the antenna series condenser are next adjusted for maximum antenna current. If the amplifier plate current becomes too high either loosen the coupling between the antenna inductance and the plate inductance or in-

crease the "C" battery voltage in the amplifier circuit. This voltage will generally be about ten per-cent of the amplifier plate voltage.

Normal plate voltage to the amplifier is now supplied. Drop back to the grid tap on the oscillator inductance and shift the clip nearer to the plate tap to get more input to the amplifier tubes. Every change in the grid clip position will require a slight readjustment of the oscillator and a slight re-neutralization of the power amplifier. Feedback through the crystal is invariably indicated by an increase in the oscillator closed circuit current, and an increase in the current in the crystal itself, as indicated by the thermo-galvanometer G in series with the crystal. When full plate voltage has been put on the amplifier the plate current may be too high. If it is, it can be brought down by either loosening the antenna coupling, increasing the C-battery voltage or cutting in additional plate turns in the coil L1.

After the whole set has been adjusted to the best of your ability, hold the key down and very carefully tune the oscillator closed circuit with condenser C until maximum antenna current is obtained, disregarding, for the moment, all other meters. It will be found, probably, that maximum antenna current is *not* obtained when maximum current is in the oscillator closed circuit.

The best indication of proper adjustment, providing the meters indicate proper neu-

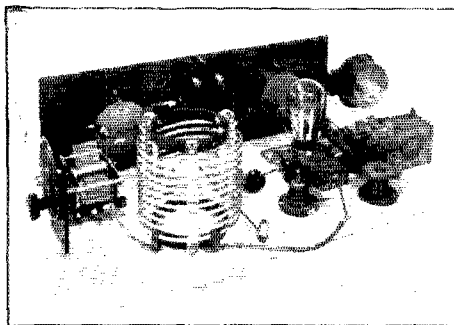

REAR VIEW OF THE NEW OSCILLATOR

tralization and no feedback, is obtained when you listen to the oscillator on a receiver tuned to *double* the wavelength on which the set is operating. When the key is depressed the note should increase greatly in intensity and should not change its character, providing the power amplifier plate supply is fairly pure. If you get one note with the key up and another slightly off it with the key down the circuits are not properly tuned and there is probably some feedback.

At 2WC a 22½ volt C-battery is used on the crystal oscillator tube when the plate

3—Again, regeneration is always present. The only way to build a compact crystal controlled set is to put the crystal oscillator in a completely shielded metal box, and if more than one stage of power amplification is used, to put all amplifier stages in similar boxes. Neutralization can then be completely carried out.—Asst. Tech. Ed.

voltage is 325, and an 80-volt C-battery is used on the power amplifier tubes with 1,100 volts on the plates. With these voltages the crystal oscillator will normally draw from 50 to 70 milliamperes with the key open. If everything is working properly the oscillator tube can be removed from its socket and with plate voltage on the amplifier

"S" tube rectifiers used in the plate supply of the power amplifiers. These are fed by another Thor power transformer. A brute-force filter using a 40-henry choke and an 8-microfarad condenser is used to smooth the output.

The second shelf contains the crystal oscillator equipment and the top shelf the two 202-A amplifier tubes and their associated equipment. The neutralizing condenser is at the extreme right on the top shelf.

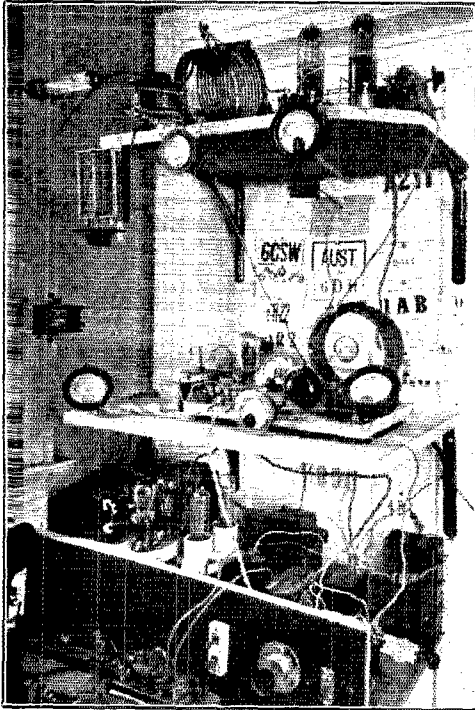

FIG. 2
THE EXPERIMENTAL CRYSTAL-CONTROLLED
LAYOUT AT 2WC

tubes nothing happens—no fireworks or plate current. If the crystal stops oscillating when you are operating, nothing happens; the load simply goes off everything until you get the crystal going again. On the other hand if the antenna or amplifier wander out of resonance with each other or with the oscillator, there will be a heavy load on the amplifier tubes and unless the plate voltage is removed in short order a few amplifier tubes may go up in smoke.

The photograph of 2WC shows the general experimental layout. The first shelf contains the power supply for the tubes. The crystal oscillator gets its plate voltage from a "Thor" plate transformer, the output being rectified by a pair of UX-216 Kenotrons. The filter in this circuit includes a Mershon 25-microfarad condenser and a 20-henry choke. To the right of the 216's are the two

Transmitting Tube Reactivation

THROUGH the courtesy of Mr. O. W. Pike of the G. E. Research Laboratory we have been supplied with the reactivation data for X-L filament tubes. Almost all of us know that a heavy overload by overheating the tube or continual operation over a long period of time with excessive filament voltage results in the filament losing a lot of its emission, and in the case of the transmitting tubes the rated output cannot be obtained. If either the tube is overheated or the filament overloaded long enough the tube may become dead, although the filament appears to be perfectly OK.

Unless the overload has been a particularly severe one, the emission can be brought back to its normal value by letting the filament burn with grid and plate voltages removed. This process can be hastened if the filament voltage is raised about 20 per cent above its normal value and burned in this manner for about ten minutes. If this does not bring the tube back to normal, the flashing and ageing process may be resorted to. Extreme care must be exercised or the filament will be ruined permanently.

The table below gives the best flashing and ageing values for four of the "transmitting" tubes:

Tube	Normal Filament Voltage	Flashing Voltage	Ageing Voltage	Flashing Time	Ageing Time
UX-213	5.0	10.0	6.0	30 secs.	2 mins. (plus)
UX-210	7.5	15.0	9.0	30 "	" "
UX-216-B	7.5	15.0	9.0	30 "	" "
UV-203-A	10.0	20.0	12.0	30 "	" "
UV-204-A	11.0	22.0	13.0	30 "	" "

If at the end of two minutes the ageing process has not brought the tube back the ageing can be continued. In general if the tube does not reactivate at the end of ten or fifteen minutes of ageing (after it has been flashed) it is hopeless to expect the emission to ever come back.

Again great care must be taken when flashing or the filament will go up in smoke!

—J M. C.

Antenna — Counterpoise Fundamentals

FOR a long time we have been using single wire antennas working with a single wire counterpoise, and usually our methods of "designing" the radiating system to fit our sets and the wavelength we want to operate on, have been even worse than "hay-wire engineering." Most of us have used the hit-and-miss method, putting up any old size antenna and counterpoise, and pruning them until they brought the wavelength down to where we wanted it.

In order to have some definite data as to what the fundamental wavelength of a single wire antenna and counterpoise really is, a very long antenna and an equally long counterpoise were erected, the fundamental wavelength of the combination connected to each other was measured, and then five feet of wire was taken out of each and the fundamental measured again. This process was continued until a sufficient number of points for a good curve was obtained.

The sketch in Fig. 1 will show the dimensions involved. In each measurement the length of the antenna and the counterpoise were the same. This length included all of the wire from the end of each wire in the shack out to the far end of antenna, and from the shack end of the counterpoise to the far insulator. The lead-ins were 17 feet long, the counterpoise 8 feet above the ground, and the antenna and counterpoise 25 feet apart. Due to the very small capacity of the single wire to counterpoise and ground, it was found that the natural wavelength was increased only $\frac{1}{2}$ -meter when the antenna and counterpoise were almost touching. This would indicate that for practical purposes the curve shown in Fig. 2 can be used for all single wire systems where the antenna and counterpoise are from 10 to 50 feet apart. This curve can be used to construct your antenna and

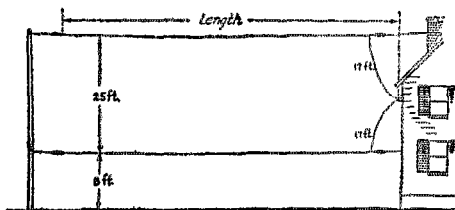
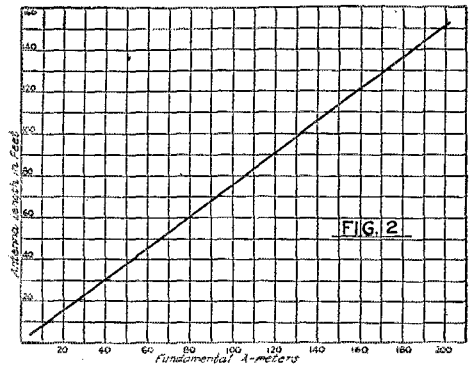

FIG. 1

counterpoise for operation at any of the amateur wavelengths above 10 meters. Of course we are neglecting the various factors which will change the fundamental of identical systems (physically) in different localities. The effect of these factors upon the fundamental is either quite small or can

be compensated for by means of the series antenna condenser in the station.

To cite only a few possible combinations of fundamentals for use with different wavelengths the following examples are given: If you should want to transmit on a wavelength of 40 meters, operating the set below the fundamental of the antenna,



a glance at the curve will show that a 40-meter antenna should have a total length of 30 feet. When the secondary inductance of the transmitter is inserted in series with the antenna and counterpoise this wavelength will be raised, but it can be brought back down by means of the antenna condenser. If you desire to operate on a wavelength of 40 meters and on the 3rd harmonic of the antenna, the antenna should have a fundamental to counterpoise of three times 40 meters, or 120 meters. From the curve it is found that the antenna should be 94 feet long. For 80-meter operation the antenna should have a length of 62 feet, when working on the first harmo. , and a 124-foot wire should be used for operation on 80 meters on the second harmonic of the antenna.

Remember that in all cases the antenna and counterpoise are to be the same length, and that this length is the total amount of wire from one end to the other.

—H. P. W + J. M. C.

Strays

Postcard postage between the U. S. and Canada is two cents and not one. Your card will come back every time if you stick on only one cent's worth of stamp.

"Kep" of 80T finds that ordinary resin can be used to "solder" broken electrical meter needles, or pointers, together when broken.

Experimenters' Section Report

AT this writing—that is to say March 27th—the returns from the reorganization and re-enrollment of this Section are coming in at a nice rate, together with a fair number of new applications. A new card file is being made and mailing stencils are being cut out for each man as his application comes in. Outlines for problem T-27 have been mailed and all men enrolled have been tied into the General Electric Tests, G-12.

General Electric Tests

2000 letters from the Radio Engineering Department of the General Electric Co. were sent out to members of this section and a large number of others in the latter part of March, the letters being sent to us and mailed at Hartford. Because of the shortness of the time before the start of the G.E. tests these letters had to be rushed thru and it is quite likely that some men were overlooked who should have been included. It is too early as yet to determine the results of the tests and at this moment we are not positive whether we will receive a May schedule or not.

The complete description of the South Schenectady experimental transmission plant which was promised for this issue has been delayed by changes of personnel and apparatus at the plant. Mr. W. T. Meenam of the General Electric News Bureau is making a special attempt to get the story in spite of these difficulties but the outcome is as yet uncertain.

Interesting Transmission Tests

Figure 1, taken from the March 1926 issue of "Rafa" (Radio fur alle) of Stuttgart, Germany, shows the results of some short-

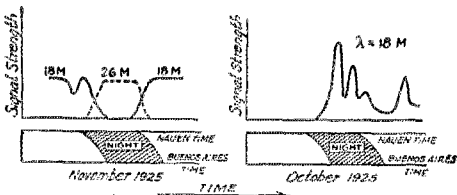
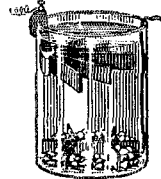

FIG. 1

wave tests between the Nauen (Germany) station of the Telefunken Co. and a station at Buenos Aires, presumably Monte Grande. The November curves are rather a shock to the widespread notion that the dividing line between "day waves" and "darkness waves" is in the neighborhood of 60 meters. For that matter we had enough information before to show that the belief was not too well founded but these curves make it especially striking.

An Old Friend Returns

Not a great many members of this section will remember the old-fashioned "gravity battery." The possibilities of such a battery for operating XL filaments in receiving tubes have been reviewed by Everett Scanlon



of Lakewood, Rhode Island. A group of 6 cells will deliver 600-800 ampere hours at a rate of 1/2 ampere or less. Thus a single 201-A tube can be operated for 2400 hours or about 3 years of ordinary reception or at least as much of laboratory oscillator work.

The Tyzzer Signal

A circular letter has been sent to all those formerly working on the "doubly-modulated schemes of transmission." This problem had to be dropped by Mr. Tyzzer and has unfortunately had to lie dormant all this time. The possible advantages of renewing the problem are now being discussed.

Other Outlines Ready

Additional outlines are now ready, some ahead of the promised schedule. If yours has not arrived please advise us.

Bulletins and Schedules

It should be remembered that there is a 30-60 day lag in announcing such schedules thru QST and that all schedules MUST be planned at least 2 months ahead if we are to announce them thru QST. We can do much better than that thru the bulletins of this Section but it takes time for your letters to get here—don't write us and expect us to have the letter in 24 hours—allow a week to make sure, and then allow another week for OUR bulletin to get to the west coast. If your transmissions are meant for Europe or Australia allow at least 6 weeks.

Our first bulletin of schedules will be pretty slim because of the failure of most of the men enrolled for the transmission problems to understand the above.

A Low-Voltage Tube

The Telefunken organization has just marketed a 5-10 watt (output rating) transmission tube known as the RS228 which should be especially useful as a laboratory tube and as low-power sending tube. The intention is to operate the tube with the ordinary 220 volt lines as plate supply while

obtaining normal output. The filament draws 1.1 ampere at 7 volts and is of the

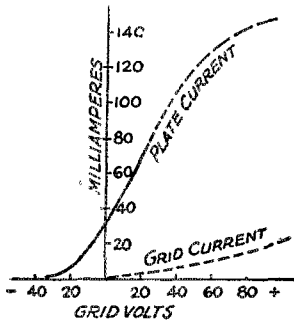

Static characteristics of RS 228 tube
FIG. 2

thorium-tungsten variety. The static curves of plate and grid current with normal plate voltage are shown in Fig. 2.

Turnbull's Field Strength Set

The general interest of this section in transmission tests suggests the usefulness

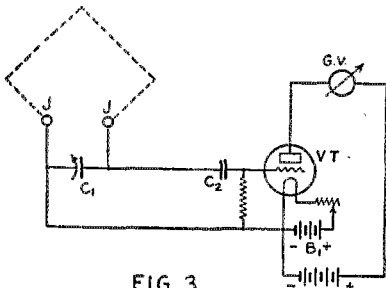

FIG 3

CIRCUIT OF THE FIELD STRENGTH SET.
J Phone-tip or G. R. spring jacks.

- C1 Variable condenser.
- C2 Grid condenser, capacity 6000 micro-microfarads.
- Gv. Weston pointer galvanometer, zero-center.
- B1 Two dry cells.
- B2 22.5 volt block plus 4.5 volt block of dry cells.
- VT UX-199 type receiving tube.

of presenting a description of the simple field-strength set devised by the late James Turnbull of Schenectady.

The circuit is shown in Figure 3. A brief study will show that a radio-frequency voltage applied to the jack terminals will produce a negative charge on the grid and reduce the plate current of the tube, it is therefore possible to use a galvanometer in the plate circuit of the tube to measure the R. F. voltage applied to the grid. The meter will of course "read downward," that is its reading will consist of a deflection back toward zero from its usual position. This "usual position" can be adjusted by the filament rheostat.

The terminals of the collecting device

(loop) are plugged into the jacks in the corner of the panel. A good substantial folding loop is used to assure that things will always be the same. For the same reason the same tube is used at all times and the preliminary setting of the filament rheostat is made in such a fashion as to give the same plate current, a good value being center scale on the galvanometer or 15 divisions on the scale of 30 parts. The R. F. voltage is allowed to reach the grid with little interference by the use of an exceptionally large value of grid condenser capacity.

Calibration and Operation

It is not ordinarily necessary to know the actual value of R. F. voltage at the loop terminals, only relative readings being necessary. However if one does wish absolute readings the set can be calibrated in several ways, depending on the requirements. The Experimenter will usually find some way best suited to his facilities. A typical curve is shown in Fig. 4. Having such a curve one can of course calculate back with the aid of the loop R (measured), the condenser capacity and so arrive at the field strength.

To make a measurement the apparatus is located at some distance from the sending antenna, the plate current set to the value that will always be used, and then the set very carefully tuned to the sending wavelength and the drop in meter reading noted. The changes in the sending set are then made and the antenna field again measured as just described. In all such work it is very important to be sure that one is at a place where the change in field intensity really represents a change in transmission—

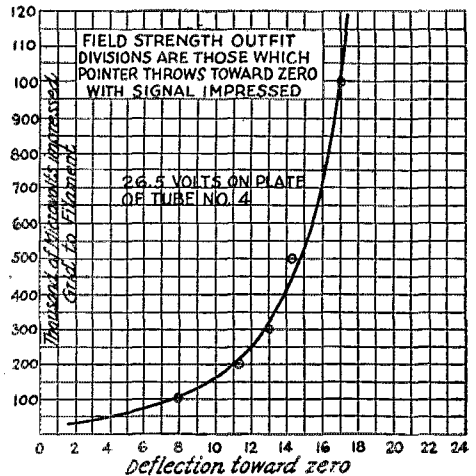
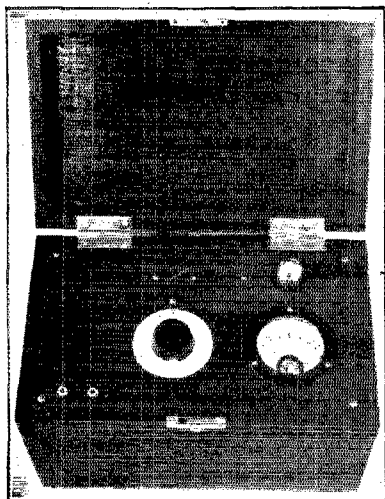

FIG. 4
CALIBRATION OF TURNBULL'S SET.

not merely a change in the shape of the antenna field. The use of several points of ob-

servation makes this a safer proposition. Naturally also one must keep as far from the loop as possible and finally the appar-



THE FIELD STRENGTH SET COMPLETE IN SHIELDED BOX

atus must be in a thoroly shielded box with the condenser shaft connected to the copper shield.

—R. S. K.

Central Division Michigan State Convention

YES, fellows, those of you in the Central Division who received the announcement about the convention at Kalamazoo, Michigan, March 26-27, and did not attend missed one of the best conventions ever held in this division, and without breaking faith with other sections, it was the best that this reporter has seen.

With a registration that beat all previous Michigan conventions Jas. A. Wilson, 8CPY, Convention Chairman, right on the dot, opened the proceedings, and every hour thereafter was filled with something of interest for everybody.

As an example of the foresight of the Committee in charge, free lunches were served both days as well as the dinner on the first day, and this resulted in keeping the "gang" together in the Park American Hotel.

Of interest to all was Fred Schnell's (former T. M.) talk on the short-wave equipment he used aboard NRRL. Doc. Woodruff, Atlantic Division Director, who also teaches electrical engineering at State College, Pennsylvania, showed himself a real ham, and the way he can build short-wave apparatus in a small space was a revelation

to all. W. G. Marburger, 8CVQ, Professor of Physics, Western State Normal School, with a whole lot of meters and batteries and a poor lonely 201-A tube, gave a visual demonstration of what happens in a tube under varying potentials and it sure was worth while listening to.

Promptly at 6.30, Friday evening, something new in conventions was inaugurated by a real-to-goodness meal being served and appropriately called "Feeding of the Wolves," under the chairmanship of A. A. Hebert, A.R.R.L. Treasurer, and which also gave him his opportunity to address the delegates and it is hoped that his remarks will not be forgotten and passed along to the membership as valuable information about our A.R.R.L. was given. Fred Schnell closed the first evening with a recital of his personal experiences on the trip of the Pacific Fleet to Australia illustrated with lantern slides. We don't know, but have the feeling that FS succeeded in showing enlistment in the Navy so attractive the Naval Reserve force will be increased greatly in a little while.

Mr. Peterson, Radio Inspector for the 8th District, was kept busy Saturday morning with examinations, and from all reports all but one or two passed with flying colors.

The Athletic Contests were participated in by an unusually large number and Frank Wright, 8CJU, and Frank Louwaert, 8VY-8CZS, had their hands full keeping track of the winners. Chinning the bar proved the most popular of all events and caused great hilarity amongst the spectators, who seemed to work as hard as the contestants.

Director Clyde Darr who had charge of the Traffic meeting kept things going by calling on all traffic officials present for timely remarks, which were well received and always prove interesting at all conventions. Of great interest was the second technical meeting in one of the class-rooms of Normal College when D. J. Angus, ADM for Indiana, gave some simple formulae on Transformer and Choke design, and R. B. Roof, 8BTF, Dept. of Physics, Battle Creek High School, handled his subject very well. Fred Marco, 9ZA, Consulting Engineer from Chicago, and a good speaker as well, talked interestingly on low-loss coils.

With a most delightful Banquet, made more so by the presence of a number of OW's and YL's, the drawing of prizes (our thanks to all the manufacturers and dealers who so generously contributed) and the best of music by an orchestra of "Kazoo" Hams the Fifth Annual Michigan State Convention came to a close. Fellows, let's all write to Jas. A. Wilson, the chairman, and express our appreciation for his hard work and that of his committee, and not forgetting the Kalamazoo Relay Club who sponsored the affair.

—A. A. H.

A Vacation Possibility

ADEQUATE national defense requires such a wide variety of specialists that the scheme includes a place for practically every one of the country's citizens.

The rapid and accurate transfer of information and orders to distant points, or, as it is known in the army, signal communication, is of vital importance to all military forces in the field or at peace time stations. Not the least in importance and in some situations the only practicable method of signal communication is by radio and in this fact lies the broad and firm contact between the national defense and the body of transmitting amateur radio enthusiasts.

For the mutual benefit of the nation and the individual amateurs who are fortunately so located as to be able to take advantage of the opportunity the War Department is providing during the summer of 1926 a CMTC (those initials need no interpretation to Young America) at Fort Monmouth, New Jersey, where the training is to be specialized and instruction given in the installation, maintenance and operation of military signal communications systems.

For a number of years Fort Monmouth, formerly known as Camp Alfred Vail, has been the station of The Signal School, United States Army, where communications specialists, officer and soldier, are developed for the Army. The facilities and instructor personnel of the School are used for the benefit of the members of the CMTC providing graded instruction through the Basic, Red, White and Blue courses which



as in other camps represent progressive stages on one of the routes via which a commission in the Officers' Reserve Corps may be obtained.

A railroad passenger agent would dwell at length on the location of Fort Monmouth in a famous seashore summer resort area: would feature the opportunities for recreation and athletics that abound there: would

call attention to the free clothing, food and shelter, and transportation charges paid by the Government. These things are all of interest and value, but the type of young man who is wanted at Fort Monmouth this summer is the one who will be interested in living in a tent, under military discipline, drilling, learning to handle a pistol; seeing how the Army radio sets are constructed, set up and operated; how military traffic is handled after communication has been established; how 2CXL (the central station of



the Army-Amateur Radio set) is built and operated; and how he may prepare himself for an important part in the nation's defense system while at the same time pursuing his beloved specialty, radio. If the number of applications warrants, examinations for amateur and commercial radio operators licenses will be arranged for.

The Camp will be conducted for four weeks beginning August 6, 1926, and further information and application blanks may be secured by candidates in New York, New Jersey and Delaware from the CMTC officer, 2nd Corps Area, Governors Island, N. Y. and by those in Pennsylvania, Maryland, Virginia and The District of Columbia from the CMTC officer, 3rd Corps Area, Baltimore, Md. Age limits for the Basic course are 17 to 24 years.

Strays

Newly arrived crystal-controlled stations: 1BQQ, 1AXA, 1CAK-1ZD-1XAX, 2CLA, 2SC, 4FM and 9ZT. Drop us a card when you convert to crystal-control.

7JF wants to apologize for failure to answer calls sooner. He has a 60,000-volt "hi line" right on top of him and QRM is always with him.

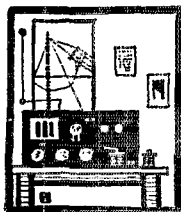

Amateur Radio Stations



2CXL-2XBB, Fort Monmouth, N. J.

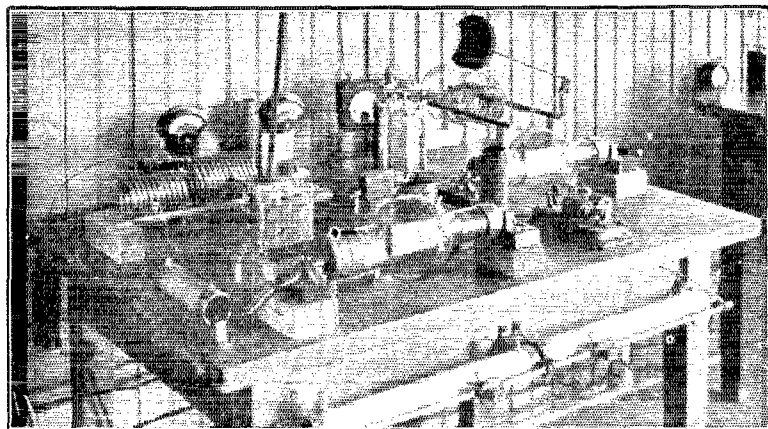

STATION 2XBB, or as it is more universally known, 2CXL, is the Army-Amateur Net Control Station, located at the Signal School, Signal Corps, U. S. Army, Fort Monmouth, N. J., formerly known as Camp Vail. Fort Monmouth is about 50 miles south of New York City.

The personnel of 2CXL includes Captain Tom. C. Rives, Signal Corps, Officer in

years. Captain Rives has long been a booster for the master oscillator circuits for short wave transmission (see "A Constant Frequency Set with A Record," *QST* pg 19, January, 1924). All powers from 5-watters up have been used. The two transmitters at 2CXL now are of the master oscillator type. The 40-meter set uses a 204 master-oscillator and a 204 power-amplifier. The large photo clearly shows this set. The oscillator inductance is at the left and the oscillator tuning condenser (with the long vernier stick) appears directly in front of the inductance. The oscillator tube is in the foreground, with the keying relay directly to the right of it. Behind the keying relay is the power amplifier. The power amplifier plate inductance and the antenna inductance are at the right, in the rear. The condenser at the left of these coils is the plate circuit tuning condenser. The lead-in from the counterpoise is supported on a long Pyrex stand-off insulator, from whence it runs through a hole in the wall and out through a Pyrex lead-in bowl. This is the main transmitter at the station. Its signals have been heard all over the world. During the last three months of 1925 this set was used to communicate with twenty-seven foreign countries. The best DX has been a measly 11,800 miles!

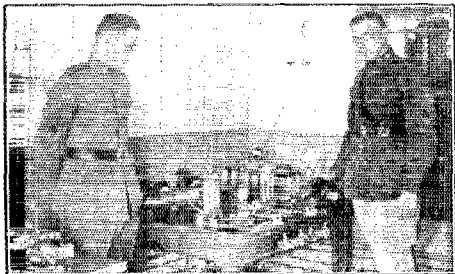

CAPTAIN RIVES (RIGHT) SGT WHITE (LEFT) AND THE 80-METER TRANSMITTER, YES. THE 204 IS WARM!

Charge; Staff Sgt. W. L. White, chief operator; Sgt. J. C. Carr, 1st operator; Pvt. Herrick, 2nd operator, and other hams attending the Signal School.

2CXL has been in operation over four

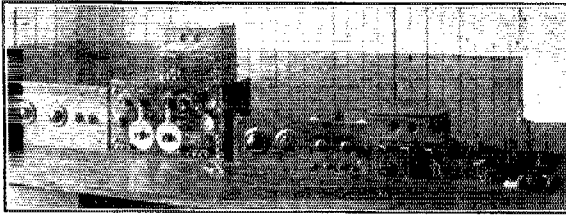

THE CONTROL TABLE SHOWING KEY AND CONTROL SWITCHES AT THE RIGHT

The first tuner from the right is for amateur waves, the one at the center of the table is the familiar IP 501 which Navy men call the SE-1420. Both receivers are connected to one of the familiar SCR-72 2-step audio amplifiers. Since the photograph was taken a horizontal antenna (Pickard style) has been added. This is no better than the vertical antenna at 30 meters but is much better at 40 meters.

The set in the smaller illustration is the 80-meter affair. It uses a 50-watt master oscillator feeding a 250-watt power amplifier. The layout of apparatus in this photo is similar to that of the 40-meter set shown above. The oscillator inductance is at the left end of the table and the power amplifier plate inductance and antenna coil at the right, with their associated variable condensers placed near the coils. Note the antenna-counterpoise lead-ins and the Pyrex stand-off supports for the wires. Captain Rives (right) is cooling off the 204 just after the set was operated and Sgt. White (at the left) appears to be blowing on the 50-watter!

The antennas at 2CXL should be a joy and pride to every ham who sees them. The 40-meter antenna, shown in the photo, is a

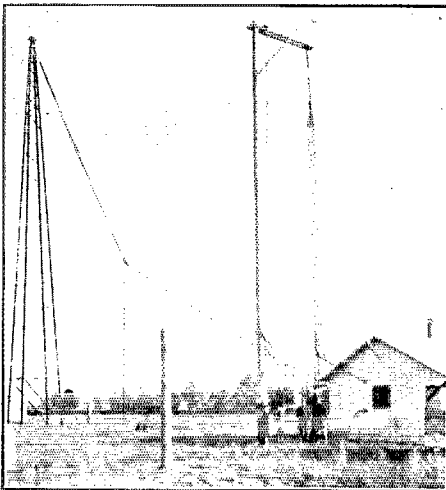

THE 40-METER VERTICAL CAGE ANTENNA. OH BOY!

four wire cage suspended vertically from the top cross-arm of the telephone pole.

The arms are long enough to keep the antenna well out of the way of the pole. Two large Pyrex insulators in series are attached to each end of the antenna. The antenna is 37 feet long and the top end is 47 feet above the surface of the ground. A "V" counterpoise is placed directly beneath the antenna. Each leg of the counterpoise is 40 feet long and the wires are $3\frac{1}{2}$ feet above the ground. One of the counterpoise wires runs between the shack and the short "ginpole" at the left of the photo.

The antenna counterpoise system is tuned to resonance with the power amplifier and oscillator by means of a series condenser in the antenna lead-in. Normal antenna current is 2 amperes on 38 meters.

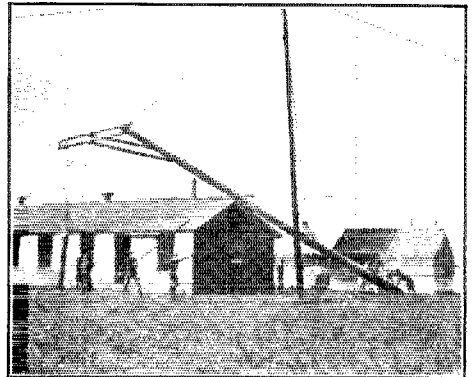

THE 75 FOOT MAST BEING RAISED INTO PLACE.

The 80-meter antenna is hung from a rope which runs to the top of the 100-foot tower at the left of the picture. This tower also supports the main antenna of WUBA, the "long wave" station.

Power supply comes from the generator room of the Fort's main station, which is about 150 yards from the short-wave house. The power unit for the short wave sets consists of a 220 volt A.C. motor driving two D.C. generators, one a 40-volt machine for furnishing filament heating supply and excitation of the high voltage generator. The latter is a 2,000-volt affair. This power unit is controlled by means of switches and relays from the amateur station.

Before the M. G. can be started it is necessary to close the master switch on a power panel in the far corner of the room. This panel also carries fuses and switches for all the circuits entering the station building.

There are a number of short, medium and long wave receivers on the operating table.

The short wave receiver uses a plug-in coil arrangement in a Weagant type circuit. The range is from 10 to 220 meters. A detector and one stage of audio frequency amplification are used.

Across the room from the control table is another table carrying the station wavemeter, the correspondence baskets, a file of all call-cards received (arranged by states and countries) and a telegraph key. This telegraph key is in a circuit which ties 2CXL to all the other radio stations in the camp, also to the office and quarters of Captain Rives and to a variety of other points.

2CXL has schedules with various stations in the U. S. and in a number of foreign countries. Shortly the station will also have schedules with the Ninth Corps Area, Panama, Philippines and Hawaii.

Official Wavelength System

THESE are two different kinds of Official Wavelength Stations. The regular Official Wavelength Station (nicknamed "OWLS") simply carries on its regular amateur communication but finishes each transmission by saying something like "9ZT 39 K", which means "9ZT on 39 meters". The station may use frequency if it wishes and say something like "9ZT 7680 K", which means "9ZT on 7680 kilocycles".

The regular OWLS plan to stay within 2% of their announced wavelengths. Thus a station may say "39" when its wavelength is really 39.5 at the time. The error is less than 2%. The regular OWLS are to let you get your bearings, accurate calibrations should be made by using the OWLS-SF or by referring to stations outside the system, such as WWV and 6XBM. Accurate points may also be gotten from NKF.

In the list of OWLS some stations are marked "OWLS-C". This means that these stations are crystal controlled and are within 1% of the announced wavelength. Crystal controlled transmitters (like all others) may at times get into trouble, therefore the stations in this list may sometimes operate without crystal control. When doing this they will usually give their wavelengths as English 5LF does—that is based on the readings from a crystal-controlled wavemeter. Occasionally a crystal-controlled station may operate while emitting two waves. Thus 9ZT operated for a while under crystal control while sending out both a 39 and a 41½ meter wave. Only the 39 meter wave had been noted at 9ZT. This has been corrected.

OWLS-SF

At present there is only one OWLS-SF (Standard frequency), namely 1XM. Later we hope to have OWLS-SF on both coasts and one in the Mississippi Valley. 1XM's

transmissions are planned to be accurate within .1%.

Meters and Kilocycles

At the present time licensed amateurs, the foreign amateur and QST, speak in terms of wavelength in meters. OWLS are privileged to use either meters or kilocycles until the time when the use of wavelengths disappears from our vocabulary.

—O. W. L. S. Committee
C. M. Jansky, Jr. 9XI, consulting.
K. V. R. Lansingh, 1XM,
in charge of S. F. stations.
D. C. Wallace, 9ZT-9XAX,
Chairman and Manager.

List of A. R. R. L. OWLS

Standard Frequency stations, accurate to .1%. 1XM.

OWLS, accurate to 1% (crystal controlled). NKF, 2WC, 9ZT-9XAX*, 4XE, 4BY, 8DAJ, English 5LF*.

*Not always under crystal control.

Regular OWLS, accurate to 2%. 1XAM, 6BQB, 7BU, 5MN, 9AAL, 9FF, 8GU-8XC, 9XI, 1CK, 1AWW, 3ZW-3BE, 8AA, 8EQ, 3APV, 5ZAV, 6ZE, 2CLA, 1ZL-1AVW, 7ACI, 9IG, 2XI, 6BGM-6CVO, 1BZQ, 2DS, 7GQ, 9EIB, 5SP, 7GE-7GX, 9ZA, 2MU, 5AKN-5XBH, 6ZH, 9EGU, 9DXN, 6TS-6XAG, 8GZ-8ZG, 9BKG, 6XAD-6ZW, 6TI, 6CDN, 8APZ, 2SZ, 7QK-7MK, 6LJ, 5OX, 9BMR, 6BCP, 1AAC-1ZO, 8BZT, 9AXQ, 9ECC, 1KP, 6BB, 6BX, 9BGH, 1CPQ, 5EW, 9CPM, 9AXQ, 5AGN, 6CAE.

Canadian. 3KA, 4FV, 9AL, 3NI.

English. 2SZ, 2OD, 2NM.

New Zealand. 2AC.

Australia. 2CM.

—D. C. W. and R. S. K.

Strays

Hey!

The low-power fiends should not overlook the excellent Jewell Contest prize, a watch with lots of Jewels. Some lad with a UV-199 is going to step in and become the proud possessor of a beautiful watch. Why doncha try, yourself, OM? If you have done any low-power work at all by all means get in touch with Jewell Electric Instrument Co., 1650 Walnut Street, Chicago. Did you get your copy of the contest rules and Log Sheet they mailed to every U. S. and Canadian amateur? If you didn't, write Jewell and raise heck with them for leaving you off, but most of all here is something for nothing. Grab it!

Grebe has been allowed the use of the letters "S-L-F" as a registered trademark for variable condensers. Other manufacturers are cautioned against the use of this combination of letters when referring to variable condensers.



British Section

"Conditions for DX work, as far as the British hams are concerned," have been very erratic during the past month. American signals come through for a few days at a time, and then completely fade out for a few days. The remarkable part is that when American conditions are bad, communication with South America and Porto Rico are always very good. Nothing extraordinary in the way of new DX records have been created by British Stations. Several two-way communications with America with powers of ten watts, and under, have been held. These include g6YR, g5YK, g5SI, g5HS, g2DQ, g6BT, and g2XV. Also Irish stations g6BT and g1IB. g2LZ has had a daily schedule with p1HR. This contact has been very reliable in spite of the fact that communication with Americans in a westerly direction has been so erratic. g15NJ has had two-way communication with p1NAJD with 98 watts input. g5HS has been QSO #8QQ several times. g2NM has been doing some good phone work and has relayed transmissions from the London B. C. station on several occasions to America and Canada. g2SZ is putting out a real steady note with a crystal-controlled transmitter. This is the first station in Great Britain to get going with crystal-control. Contact with the antipodes has been very poor due to bad static they are having out there at present. The best DX work by g2LZ was made on February 7th when during a space of six hours the following two-way contacts were made: p1HR, #8QQ, z2BX. Egypt, EGEC, a3EF, aA6N, c2BG and u1CAL. Important research work can be carried on by hams in various parts of the world in determining the cause of the good and bad conditions which occur from time to time. Conditions are so far mostly attributed to weather conditions, but this remains to be proven. Two-way schedules should be arranged as far as possible and careful note made of signal strength, weather barometer, temperature and moon. Some interesting information might then be obtained. g2OD has been carrying out long distance work with fone on 23 meters and has been very successful. He would like to arrange schedules for work on this wavelength. g2OD being an O. W.

L. S. is using quartz crystal standards for wavelength readings.—*E. J. Simmonds, President, British Section.*

Hawaii to South Africa!

A very beautiful piece of DX work was pulled off on the morning of February 12th when hu6DCF (FX1) at Fort Shafter, Hawaii and oA4V at Johannesburg, South Africa were in communication for 35 minutes. hu6DCF sent the following message: "Greetings half way around the world from U. S. Army and Radio amateurs of Hawaii" to which oA4V replied with a message of greetings from the South African Radio Relay League to all the gang. Sgt. H. W. Wilson of the U. S. Army Signal Corps operates 6DCF-FX1. Congrats OM's and Fine Business.

Both Ways Around!

Last month we told of u6OI-g2LZ's DX "the other way around." This month we have one even better than that. Colonel Clair Foster at u6HM believes in doing unusual things. Wentworth and Mayer beat him to the "other way around" idea, so the Colonel

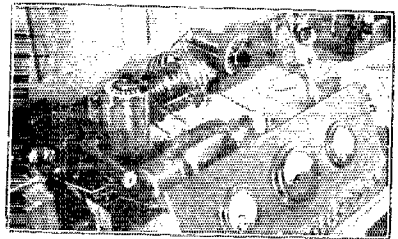

THE BIG TRANSMITTER AT u6HM

decided he wanted to try working both ways around, all during the same evening (or morning). And he succeeded! Between 8:40 and 9:10 p. m. P. S. T. on the night of March 10th, 6HM and oA3E were in communication. They made a tentative schedule for the following morning, during which time the "dark zone" had shifted so that the waves would have to travel the long way around. The next morning (the 11th) they *did* connect and held contact from 6:55 to 7:40 a. m.; Splendid! In order to prove to their satisfaction that it was not freak work

they made schedules for the next night (morning in South Africa) and morning (night in S. Africa) and they held good contact perfectly on both schedules. The tests were continued, and up until the time that this is being written they have been QSO both morning and night for four consecutive days! Vy F. B! On the night of March 13th Colonel Foster sent a3E the following message from Headquarters: "Congratulations on your great work. Please send photos of self and station and full description for QST." This was on the night of March 13, and the signals, presumably, travelled the short way, approximately 10,000 miles. Now, that message reached South Africa in the morning of March 13th, hi! The next morning (U. S. Days) a3E gave 6HM a reply to his message. This message probably came the dark route, or 15,000 miles. That is getting-around-the-world relays down to a fine point. Two stations participated in an around-the-world relay. And we believe it will be a long time before a single station pulls this off! Another pretty piece of work happened when a3E sent a message to 6AWT reporting hearing his signals. This message was given to 6AWT fifteen minutes after a3E heard him originally! 6HM handled it.

New Zealand

By radio through 5ZA1-9ZT and z2XA-z3AF-z1AO we have the following account of New Zealand activities: Apparently high power is quite unnecessary for DX work. NKF recently reported z2XA as R7 when he was using only 85 watts input in a new tube. z2XA's normal input is around 250 watts into a Western Electric 50-watt tube. z2XA recently received sigs of u8GZ when the latter was using a UV-199 with an input of less than six tenths of a watt. Signals were very QRZ but nevertheless readable. New Zealand has a real dyed-in-the-wool OW. She is Miss Bell of z4AA and sister of the well-known Frank Bell. She is keeping the station on the air while Frank has gone to Europe on his honeymoon. She is a real ham. z2AC was the first nz station to establish contact with Germany when he worked KY8. z2AC has a new transmitter he calls his silver-plated set. Input is now 250 watts and note much steadier. Amateurs in New Zealand would like it known through QST that they certainly do appreciate the kindness and courtesy of the operators at NKF. We can always rely on getting a reliable report and what is more important an accurate wavelength report. NKF's signals can be copied single on all sorts of bum nights. Winter is approaching now and the DX already seems to be improving. Quite a lot of new low power ham stations are coming on the air and all are very anxious to be QSO the U. S. z3AD has worked England with an input of only 2.5

watts. Withers of z3AM is in the U. S. His station is being operated by L. Halcrow who requests that all QSL's for z3AM be sent to 441 Madras Street, Christchurch, N. Z. z2BX has been working gi, and pi stations with a 5-watt tube. Then he blew it! All New Zealand stations are bothered by very heavy commercial I. C. W. QRM right in the middle of the U. S. 40 meter band. If they could only move up above 45 meters everything would be OK.

Germany

From L. V. Stockmayer, Secretary of the German Section of the I. A. R. U., we learn that when the German Transmitters Association was founded at Jena in January, it was decided that as soon as possible a day would be set for a series of transmissions on the part of all German amateur stations to the special receiving operators who act as observers. Advance notice was given by means of the mails, announcements through B. C. stations and over amateur radio station broadcasts and on February 21st, 39 transmitters were in operation and over 1,700 QSL's with all kinds of data were received. The work now remains of tabulating and analyzing this information. It is hoped that reports of value will be discovered. The German amateur's are immensely with their initial test, since organized amateur radio in Germany is quite young.

"ANK"

A new spot on the globe has been reached by amateur radio. On March 11th, Decker, of u1RD was QSO ANK who gave his QRA as the Savoy Geographic Expedition in the Sahara Desert, 1000 miles west of Cairo, Egypt and about 1,500 miles south of Tunis. His wave was 44 meters, QSB R. A. C. and 1RD reported him R3 to R6 with a lot of fading. Apparently a portable set with hand driven generator was used at ANK. A few minutes later ANK was QSO u2GK at Schenectady and later 8BPL, 2PP, and was copied by 1BBK, 2AER, SDSY and 8ZAE. We hope that we receive further particulars concerning this Expedition. If anyone has them, by all means lets hear from you.

Denmark

d7AA informs us that the following Danish stations are actively engaged in ham radio work: 7ZM, 7BZ, 7BX, 7AX, 7AA, 7MT, 7EW, 7XP, Y. OYZ, 7ZG, 7IO and 7MZ. Reports from the U. S. will be greatly appreciated at 7ZM and 7AX are the only stations who have gotten across. 7EC is no longer in regular operation. Cohrt has left Denmark and is now with the Bell Telephone Company in Antwerp, Belgium. He can be reached if addressed care the Installation Department of that company. He contemplates installing a transmitter in Antwerp. At last the Danish stations are

receiving licenses from the Government. It has taken some time to accomplish this and the amateurs are very pleased. New calls will probably be heard on the air soon.

Italy

i1ER reports several new contacts. On February 20th the first Italian-Tahiti contact was had when 1ER worked KFUH. The next night i1ER hooked up with GFUP in

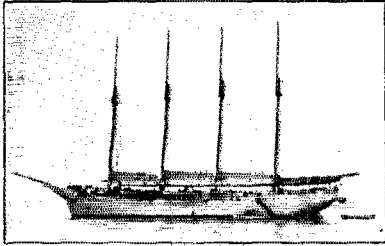

KFUH AT AUCKLAND, N. Z.

China. i1RG is working on fone every Sunday at 0600 and 1400 GMT on 35 meters. He will appreciate any and all QSL's addressed to Ernesto Montu care il Radio Giornale, Milan, Italy.

Ship to Land.

KFUH has been heard from again. Through 9ZT we received the following resumé of the schooner's trip, about which we have known very little in the past: "KFUH left Honolulu on July 21, 1925 for a South Sea cruise of one year. Eight months have elapsed. In that time the vessel has visited Fanning Island, Jarvis Island, Penryhn Island, Tahiti, Moroea, The Society Group, Apia, Fiji Islands and many other points. During the cruise, so far, over 25,000 words of traffic have gone forward via short wave, and less than 1,000 words on 60-meter spark. More than one thousand direct contacts with American amateurs have been had. Foreign contacts include China, Japan, India, Italy, France, Porto Rico, Canada, South American Countries, Samoa, Australia, New Zealand and several ships. Limited time for intensive operation has prohibited any concerted attempt at piling up records in European communication. During the past eight months the busiest and most consistent daily schedule maintained has been with FX1 at Honolulu. FX1 has supplied KFUH with press amounting to over 20,000 words, in addition to a lot of traffic. Frequently when copying press or broadcasts on long waves, static of the tropical variety broke up reception to where it was impossible. Over 500 words of press have been taken at a time on the mill from Wilson at FX1, on short waves. Regardless of distance the 40 meter signals from amateurs have remained practically the same, throughout the voyage. KFUH has handled

over 2,500 words of official communication between NRRL and the American consulate at Papeete. Schedules at the present time are kept with FX1, 9XI, 6HV, 6KB, 6OI, 5AKY and GDVB."—*Roebuck, op KFUH.*

u2LD reports working SKA, the Swedish motorship *Axel Johnson* while the latter was at anchor in Puerto Columbia.

8ATX worked the ss *Wellington*, call GVO, while she was off the coast of India. GVO's QRH was 33.2, power 500 watts, 1,000 cycle I. C. W. The operator is anxious to arrange schedules with amateurs all over the world. The ship regularly runs between Bombay, India and Buenos Aires.

8BTD hooked the ss *Dyatt*, KIWD, 76 meters and a 250-watt tube when she was off Italy. 8BTD says the note was rectified A. C. Anyone else heard this one?

Madeira

2PP and 1CV tell us of a new one whose signals we had heard of before, but whose QRA we did not know. It is p3GB, Branchi, Funchal, Madeira. Madeira is in a group of small islands off the coast of Africa.

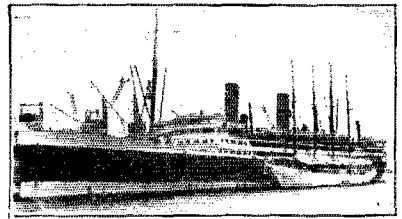

GDVB, THE M. S. "AORANGI" WELL KNOWN ON SHORT WAVES

ALL HAMS ATTENTION!

The Holland amateurs are in trouble. They have asked that we notify all amateurs outside of Holland not to supply the QRA's of Holland stations to *anyone*; also that any QSL cards or reports to them be sent under cover in an envelope.

Strays

BCL: "Look here, your raw A.C. is causing too much interference." c1CO: "Sorry, sir. I will see that the matter is rectified."

Even though our A.R.R.L. Publicity Department has been disbanded, the "Inkslingers" in the Midwest Division haven't quit work. Far from it, they have reorganized as the Midwest Division News Bureau, with L. Boyd Laizure as Manager, and are carrying on the good work. L. R. Huber, 9DOA, is assistant for Iowa, H. J. Becker, for Missouri, and R. E. Veverka, for Nebraska. They have their own "Inkslinger" and are doing the job up brown. FB!

Correspondence

The Publishers of QST assume no responsibility for statements made herein by correspondents



Regeneration Control

Norwood Avenue,
Schenectady, N. Y.

Editor, QST:

Some of the gang may be interested in some of my recent experiments with a different type of regeneration control for a short-wave receiver. These experiments cover a period of about two months and during this time the receivers were tried on all ham bands except the 5-meter one.

The main idea lies in the use of a resistance to control regeneration and oscillation in the detector tube. This, if properly done, has several advantages. The relative merits of the circuits shown are as follows:

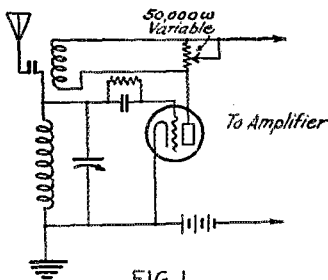

FIG. 1

1. Good signal strength, but signals erratic. Control is noisy and uneven. Generally poor.

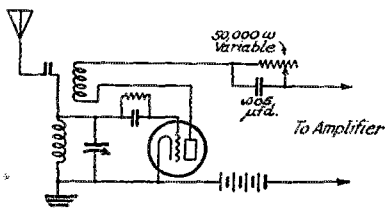

FIG. 2

2. Much better. Excellent signals; control very smooth and practically free from contact noises as resistance is varied.
3. Best of all. Control very smooth, excellent, much greater sensitivity, less extraneous noises.

While I do not claim any originality for any of these circuits nevertheless I do not

believe I have seen a comparison of them in QST. One additional advantage in the resistance control method lies in the fact

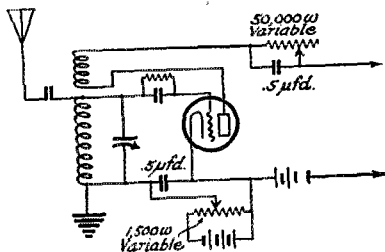

FIG. 3

that the expense of the regeneration condenser is eliminated and since this condenser is not necessary, the receiver may be built into a smaller panel.

I might add that I tried over 70 different tubes in these sets. The UX 199 was by far the most sensitive detector of them all. I have several tubes of each type and am sure that the sensitivity of the 199 was not due to freak characteristics of any one particular tube.

—E. H. Hobbs, 2ADM

QSL, OM, QSL

18 Prospect Hill Avenue,
Somerville, Mass.

Editor, QST:

We Americans, pioneers in the advancement of amateur radio, may feel justly proud of our achievements. We have made a creditable record in the relaying of messages by the establishment of relay routes. Our League is recognized the world over as the greatest organization in its field and we certainly have set an example in international communication.

There is one thing of which we cannot feel proud and that is the answering of QSL cards. A QSL card is something more than sixteen square inches of wall paper; it is a symbol of co-operation, a token of appreciation.

I do not expect that every station I work should send me a card. I do not send a card to every station I work, myself. Yet when a card is received I answer it. I have received cards from fellows, mostly B.C.L.'s, less than five miles away. Some of these

cards were so crude they were thrown away, but all of them were QSL'd

Maybe you have unlimited power, maybe you have a pair of fifties, maybe you punch out a wicked signal clear to Australia and do not appreciate cards from the East coast, but how about the fellow who would appreciate a report but is denied one because of your selfishness?

I have been in communication with several fellows in Kentucky and since I have never received a card from a station in this State I would appreciate a card from them. But I am not DX enough for them or because they feel that since my card is already secure on their wall (or in their wastebasket) it does not need an answer. Is this indolent "I don't care" attitude what we want the A.R.R.L. members to show?

Maybe you don't believe in sending out cards yourself, but if anyone takes the trouble to secure a card, look up your address, put a stamp on the card and put in a box just remember that he is waiting for an answer.

—Joseph R. Corisk, 1CV

Bugs

City Club,
Barberton, Ohio.

Editor, QST:

Every bit of transmission from stations 6CMS and 6CMU during 1925 was sent on a bug, without, as far as I know, any trouble about copy at the other end, and the secret is this:

Use at least three weights on the lever of the bug and have them on the very end of the lever. Or if you have no extra weights, use both weights and wrap an ounce of wire solder around them. With this arrangement it will be very hard to send faster than 12 words per minute. Because you can send about 40-per on a bug is no reason why you shouldn't slow down. But don't buy one and get right on the air with it. I practiced on a buzzer for three months before I ever got on the air with mine.

If more of the "nerve" senders would get bugs, slow 'em down and learn to use 'em, the air would sound better at night. A bug properly operated can't be told from a good straight first except that the bug is somewhat better.

I crave discussion on this matter and lots of it.

—W. H. Hardy, 8CJW, ex6CMS

Plug-In's

150 Aberdeen Ave,
Hamilton, Canada.

Editor, QST:

The present day fad for all things "plug-in" reminds us of new uses for the old and

obsolete honeycomb coil plug. Two of them with a little care and some electric tape (to cover up the binding screws) make dandy polarized connectors for the power supply line of your transmitter or test table, if the voltages are not too high. One fastened to the breadboard of your transmitter and another connected to some lamp cord makes an A-1 "plug-in" for your key, microphone, voltmeter or what ever you have to be plugged-in. By carefully sawing one plug down the center between the two contacts you will have the plug and jack for one terminal of the coil on that "plug-in" coil receiver.

—C. Hartley Hunter

Postage Due

54 Penn Avenue N.,
Minneapolis, Minn.

Editor, QST:

Perhaps it has not occurred to many in the amateur fraternity that the card question is an item of considerable expense to some of us. We often receive envelopes with postage due and with post office stamps similar to this one:

"This letter was posted insufficiently prepaid. Please advise your correspondent that the rate on letters to America and foreign countries is first ounce 3d, each additional ounce or fraction thereof 1½d."

This appeared on a letter from Australia. On the day this letter came in, nine cards or letters were received from foreign countries; a good share had postage due on them.

When we figure that it costs 4 cents in stamps to answer these, plus 5 cents postage due to receive them, plus the cost of the card of about 2 cents, we find the total to be 11 cents a card. It is entirely possible that on a day like last Saturday, the card expense for the day to foreigners only would amount to 99 cents.

Some of us like to spend a little of our money on our sets and a dollar a day is a good deal of expense for cards. Accordingly the writer, along with many others, appreciates very much the recent steps you have taken in the QSL card problem. At the present time cards are being answered in accordance with this schedule, which by the way is pretty heavy.

—D. C. Wallace, 9ZT-9XAX

More Flowers

Boston, Mass.

Editor, QST:

The latest number of QST reached me last night and I have neglected my family and my business since its arrival. How do you fellows manage consistently to make each number better than the preceding one?

Months ago *QST* was by far the best of the radio magazines—the others aren't in the running now. Seriously, although I am little interested in transmission (experimenting in receiving work takes all of my time) yet *QST* is the most fascinating reading that comes to me. The informal way of handling the articles, the frankness with which you acknowledge past mistakes and the way the T.E. takes into his confidence in his footnotes are so refreshing and so novel that I can't help bubbling over with delight as each new issue comes to me.

Please accept my best wishes for continued success in your work, and give my regards to the rest of the bunch.

—Arthur V. Getchell, 8LO

Low Loss Lead-Ins

Shinnston, W. Va.

Editor, *QST*:

In looking over pictures of different stations in *QST* I notice that very few hams use good low loss lead-in insulators. Here is an insulator that should satisfy the lowest low-loss fiend in the world. It is also of great value to those who are unable to bore holes in the walls or window casing.

Figure 1 shows an ordinary window frame which has been cut down to fit a plate glass eight and one half inches wide. The frame should fit the window through which the lead-in is to be brought. Holes are bored through the plate glass about six inches from each end. The plate glass is then put into the cut down frame in the same manner that any window pane is put in. This frame is then placed under the old window frame as shown in Fig. 2. Custard cups with holes through their bottoms are next put on each side of the window pane. The holes can be drilled from specifications shown in past issues of *QST*. The antenna and counterpoise wires can be used to hold the cups in place, or better still a length of threaded brass rod can be run through a cup, through the hole in the pane and then through the other cup. Nuts on the inside and outside will hold the cups securely in place. With an arrangement of this sort rain and snow are kept off and a very efficient lead-in insulator results.

—Paul D Tennant 8JZ

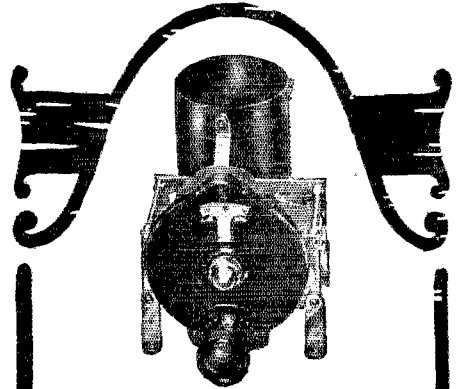

BD-1B Includes the NATIONAL Equicycle (straight line wave length) Condenser and the genuine BROWNING-DRAKE Inductance Coil with the new Type B Dial. Price \$9.25

THE NEW NATIONAL Tuning Units

Comprising the genuine BROWNING-DRAKE SPACE WOUND TRANSFORMER

and the NATIONAL Velvet Vernier

Dials and Condensers

Are now in the hands of your dealer. Their beauty and efficiency will greatly surprise you. See them at your dealer's.

Send for Bulletin 105 Q.S.T.

See our exhibit at the Hudson Division

Convention NATIONAL COMPANY, Inc. W. A. READY, President, 110 Brookline St., Cambridge, Mass.

BD-2B Includes the NATIONAL Equicycle (straight line wave length) Condenser and the genuine BROWNING-DRAKE Transformer with the new Type B. Dial. Price \$12.75

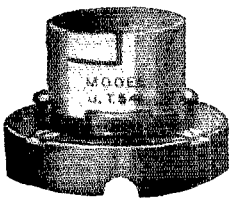
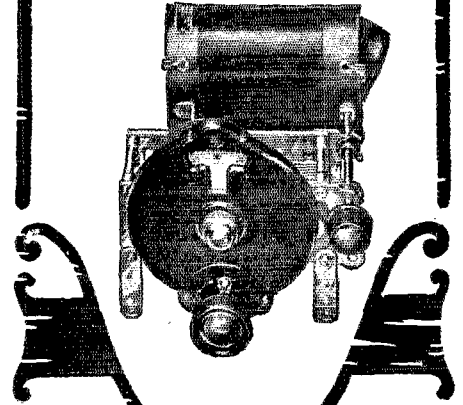

50 WATT SOCKETS



Model UT-541



These Porcelain Sockets are ideal for use in short wave work on account of their low specific inductive capacity and their high insulating quality.

NEW. You can afford a few extra sockets at **OUR SPECIAL PRICE \$1.10 EA.**

AMERICAN SALES CO.,

21 WARREN ST., N. Y. C.



What Size Grid and Plate Blocking Condensers?

You have always used .002 mfd. for blocking condensers but who knows that it is the best size for short waves? The builders of KFUH believe .000036 mfd. better for their tuned grid 'n plate circuit. Our UC 1015 condenser gives eleven different capacities between .0002 mfd. and .001 mfd. so you can select the best size for your set. Why not try them?

Price \$1.25 postpaid

General Electric Gridleaks



We also sell General Electric blue enameled gridleaks at \$1.25 for 5000 ohm size and \$1.75 for 10,000 ohm unit.

UTILITY RADIO CO., 58 No. 6th St., Newark, N. J.

The S-C SILVER COCKADAY "All Wave Receiver"



Send for this
New Hookup

THE NEW 4-TUBE RECEIVER

Sponsored by Popular Radio, endorsed and described by Radio publications and Newspapers from coast to coast. Perfected Single Control—Unlimited wavelength range—Volume equal to 6-tube receivers—Quality unsurpassed and hair-line selectivity. Easily assembled by even a beginner with just a screw driver and pliers.

REPRESENTED MANUFACTURERS:

Belden Mfg. Co.—S-C Wiring Harness.
Central Radio Laboratories—Central Resistance.
Polymet Mfg. Corporation—Fixed Condensers, Leak and Leak Clips.
Pastor & Co.—Drilled and Processed Front Panel and Drilled Sub-Panel.
Silver-Marshall, Inc.—Variable Condensers, Coil Sockets, Coils, Tube Sockets, Vernier Dial, Mounting Brackets.
Thordarson Elec. Mfg. Co.—R200 Power Transformers.
Yaxley Mfg. Co.—Rheostat, Jacks, Switch.

Send 25c for S-C Building Instructions today or see your dealer

S-C MERCHANDISING CO.

730 Lyon & Healy Bldg.

Chicago

DON'T FORGET TO GET
THAT AUTO EMBLEM!
SEE PAGE 84

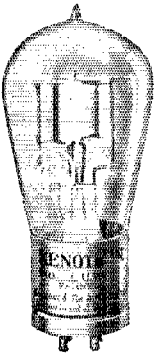

GENUINE Kenotron Rectifying Tubes Model UV-216



THESE Tubes are the GENUINE R.C.A. Kenotron Rectifying tubes. Filament voltage $7\frac{1}{2}$ volts and will safely stand A.C. input of 750 volts. Four of these tubes will run a 50 watt.

These Rectifying tubes will pass plenty of current and voltage for your transmitter and also are very efficient for use in "B" Eliminators.

STANDARD BASE, EVERY TUBE BRAND NEW AND PACKED IN ORIGINAL CARTONS.

List price \$7.50 ea.—**Extra Special \$1.85 ea.**

AMERICAN SALES CO., 21 Warren Street, N. Y. C.

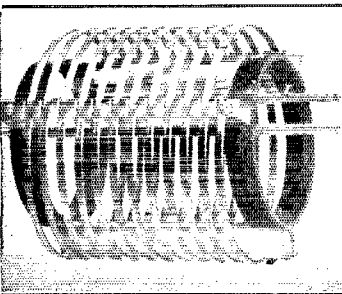

TRANSMITTING INDUCTANCE FLATWISE WOUND ON GLASS

ENDORSED BY LEADING AMATEURS AS THE IDEAL INDUCTANCE FOR C.W. TRANSMITTERS.

Type "L"—5" Dia—11 1/3 turns—for 40-80 and 150 Meter Bands.
Type "S"—3" Dia—11 1/3 turns—for 20 Meters and lower.

Single Units with 3 Clips—Price \$5.50
Two Units (Pri. & Sec.) with Two Glass Coupling Rods—Price \$11.00

RADIO ENGINEERING LABORATORIES

27 THAMES STREET, NEW YORK N. Y.

Sending the News of Marion Talley's Triumph

With the Improved Martin



Lopez Photo Courtesy
New York Herald Tribune

While thousands of clapping hands acclaimed Marion Talley's triumphant debut into Grand Opera, her father sat in the wings of the Metropolitan Opera House New York, and with an Improved Vibroplex sent the news to the folks back home.

Reg. Trade Marks
Vibroplex
Bug
Lightning Bug

VIBROPLEX

The World's Greatest Sending Device

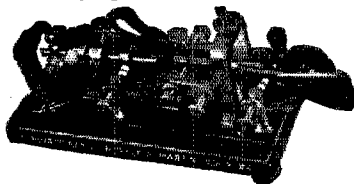

Japanese Base
\$17
Nickel-Plated
Base
\$19

The Improved Vibroplex always is the choice of operators on land and sea, because it transmits clear clean-cut signals—the kind they like to hear, with less than a third of the labor of key sending.

You simply press the lever—the Vibroplex does the rest. Saves the arm. Prevents cramp. Enables the "ham" to send with the skill of an EXPERT. Used by over 100,000 Morse and Wireless operators.

A special model Vibroplex designed for use without relay is now ready. This model is equipped with to break high current. Just what every Wireless operator needs **\$25**

For Continental, Morse or Navy Codes

Whether amateur or licensed operator, you need an Improved Vibroplex to be up-to-date. **ORDER YOURS NOW!** Sent anywhere on receipt of price. Money order or registered mail.

See the Vibroplex at the Hudson Division Convention

THE VIBROPLEX CO., Inc.

325 Broadway, New York

Silence the Thunder of the Near-by Station

Bring in the Ones You Want
KFI WCCO WEAF



Filtrola

THE STATION YOU DON'T WANT



GROUND IT OUT!

No longer need your radio set, if it is fairly selective, remain at the mercy of some near-by station whose signals are audible at all points on the dials. The Filtrola will "drop out" for you the station to which it is tuned, leaving the air as clear as though the near-by station had signed off.

Price \$15

ALL-AMERICAN RADIO CORP.
Pioneers in the Industry
Belmont Tripp & Kenosha Aves., Chicago
Owning and Operation Station WENR—266 Meters

ALL-AMERICAN

Radio Built for the Years to Come
SAY YOU SAW IT IN QST—IT IDENTIFIES YOU AND HELPS QST

Use Type 719 across the transformer secondary

Circuit diagram for Raytheon plate supply

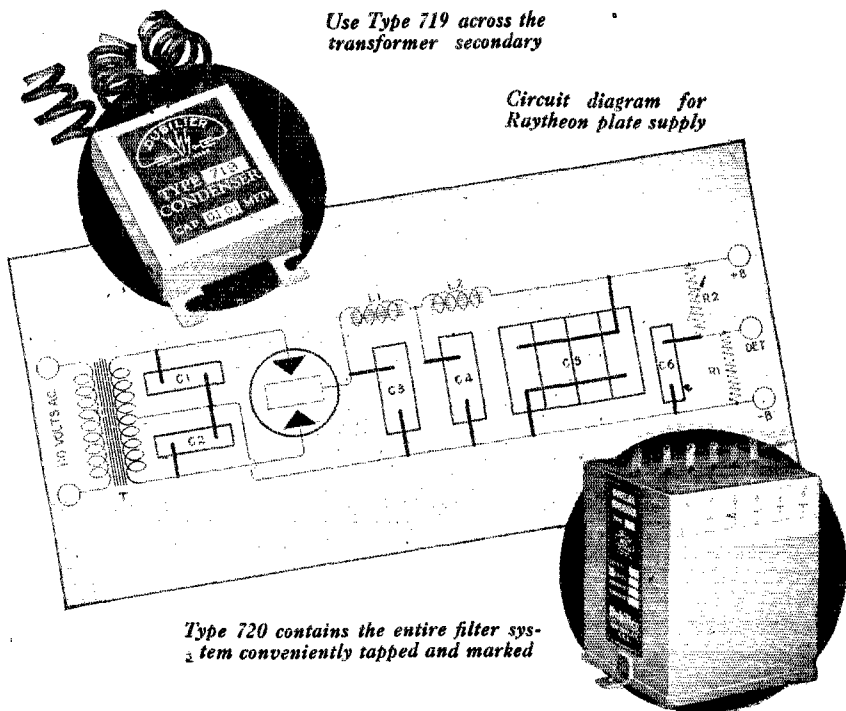

Type 720 contains the entire filter system conveniently tapped and marked

Your filter condensers must be right!

One of the most popular types of home-built "B" battery eliminators uses the Raytheon tube as a rectifier.

As in every other type of plate supply unit, lasting satisfaction and safe operation depend on the use of proper filter condensers. Due to the high voltages impressed on the filter circuit by the input transformer, only condensers especially designed for this work will give permanent service. Ordinary By-pass condensers should not be used in filter circuits.

Dubilier Filter Condensers, Types 719 and 720 contain all capacities necessary for constructing a Raytheon plate supply unit. These condensers were specifically designed for this circuit.

You can't build right unless your parts are right!

*Insist on getting DUBILIER Filter Condensers.
If your Dealer cannot supply you write directly to*

Dubilier

CONDENSER AND RADIO CORPORATION

4377 Bronx Boulevard, New York, N. Y.

*Only the
hard facts
mean anything*

To you radio technicians who know the difference between a micromicrofarad and a microfarad, there is also an obvious electrical and mechanical difference between Benjamin Radio Parts and just radio parts. Benjamin Electric Mfg. Company's first aim is to attain the radio authorities' approval on the quality and results secured with Benjamin Radio Parts. Then it is sure to secure the acclaim of the layman. Even you, when you know Benjamin Radio Parts, will be enthusiastic about the facts of their fine quality and substantial performance.

*Get our literature on Super Products
for better all the year 'round radio*

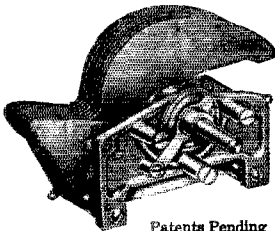

Patents Pending

Benjamin Straight Line Frequency Condensers

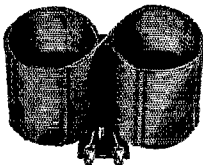

Patents Pending

*Benjamin
'Lekeless' Coils*



Patented July 25, 1925
May 2, 1911

*Benjamin
Cle-Ra-Tone Sockets*

Benjamin Electric Mfg. Co.
120-128 So. Sangamon St.

New York Chicago San Francisco
247 W. 17th St. 448 Bryant St.

Manufactured in Canada by the Benjamin Electric
Mfg. Co. of Canada, Ltd., Toronto, Ontario

BENZAMIN
TRADE MARK

The *why* ADVANCE "SYNC" RECTIFIER

is preferred by amateurs all over the world

1. The ADVANCE Sinc Rectifier actually does what any other rectifier claims to do.
2. Can be easily and quickly filtered.
3. Meets all requirements for heaviest duty.
4. Speedy starting because of Advance Bakelite wheel.
5. Requires no attention—always ready.

Its prevailing use in international transmitting is evidence that, although lower in price, the advance Sinc Rectifier is superior in quality.

Revolving disk is moulded bakelite six inches in diameter. Nickel plated brush holders with adjustable gauze copper brushes. Convenient control handle. Disk, aluminum brush arm support and brush holders perfectly insulated.

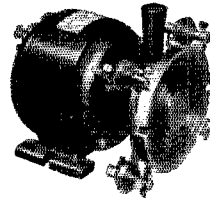

Price complete with Westinghouse $\frac{1}{2}$ H. P. Synchronous Motor ... \$40
Rectifying wheel with complete brush assembly and mounting ring to fit your own motor ... \$15

We Pay All Transportation Charges in U. S. A.
ADVANCE ELECTRIC COMPANY
1260-1262 West Second St., Los Angeles, Calif.

This is the new
**TOBE MS IV — 8
Watt Transmitting
Tube.**

OPERATING DATA

Filament volts—6.
Filament current—2
amps.
Maximum plate volts—
800.
Plate current—40 M.A.

1. This tube is characterized by extreme hardness.
 2. Careful and rugged internal construction.
 3. Bakelite base.
- Unexcelled for technical precision and durability.

Price—\$6.00

At your dealers, or
send check or money
order to

Tobe Deutschmann Co.

Cornhill, Boston, Mass.

We sell transmitting condensers, too.
Send for literature.

QST readers will be welcome at our booth at the Hudson Division A.R.R.L. Convention. Come in and get acquainted.

The
first man
who saw a
"B" battery
work in
Radio . . .

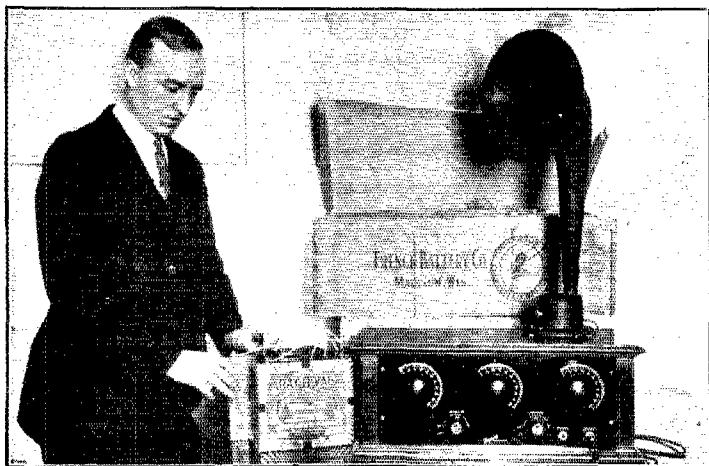

endorses this low resistance battery

ABOVE is a photograph of Mr. Charles V. Logwood. He is the Chief Research Engineer of the Electrical Products Manufacturing Company, makers of Dymac "Selecto-Five" Radio receivers.

What has he done in radio? He is co-inventor with Dr. Lee de Forest of the audion tube, which made broadcasting possible. Mr. Logwood alone discovered the audion amplifier, which came into use in 1912. He directed the installation of the first three broadcasting stations in the United States. He was the first man to listen to sound transmitted by an audion tube. He knows, if any man knows, what is necessary to make radio tubes work—at their best, day in and day out.

He says, "'B' batteries *must* have low in-

ternal resistance in order that the detector tube can work without creating distortion in the audio stages. It gives me a great deal of pleasure to endorse the Ray-O-Vac battery for its long life, and its low resistance efficiency in detector and audio amplifying circuits."

This opinion from such an authority as Mr. Logwood is significant, because it indicates what leading experimenters are doing for current supply. They are using Ray-O-Vac batteries and avoiding a lot of the trouble that comes from high internal resistance in other kinds of current supply.

You will find that Ray-O-Vac radio batteries give you similar advantages in transmitting as well as receiving. And in all kinds of radio work—reception, transmission, experimentation—Ray-O-Vac batteries have *staying power*. They cut down operating costs while giving better service. You buy Ray-O-Vacs less often.

You can undoubtedly get Ray-O-Vac radio batteries from the stores where you usually trade. If you have any difficulty, write us for the name and address of a nearby dealer or jobber who can supply you.

FRENCH BATTERY COMPANY Madison, Wisconsin

Ray-O-Vac "B" Batteries in all standard sizes, both flat and upright.

Ray-O-Vac "A" batteries recuperate during rest periods, lasting longer and giving excellent reception.

Ray-O-Vac 4½ volt "C" batteries with 3 variable terminals, give voltage adjustments of 1½, 3 and 4½ volts.



ANNOUNCING
The New
**FROST-RADIO
GEM-JAC**

The Jewel of all Radio Jacks

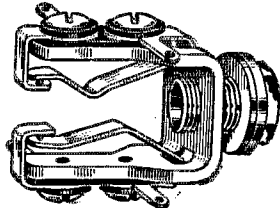

List:
50c

FROST-RADIO

No. 951 Double Circuit Gem-Jac

THE NEW **FROST-RADIO GEM-JAC** is ready! It is the smallest and most compact radio jack made. An entirely new principle in spring design. The GEM-JAC projects only 1 inch back of panel. Has extremely low capacity effect, self-cleaning contacts, Bakelite insulation, sterling silver contacts, nickel plated brass frame. **FROST-RADIO GEM-JAC** gives you more room in your set for other parts. Order from your dealer now

No. 953 Open Circuit type, 40c
No. 954 Closed Circuit type, 45c
No. 951 Double Circuit type, 50c

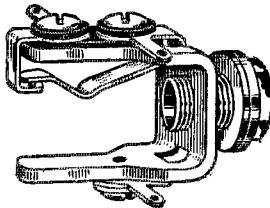

FROST-RADIO
No. 954
Closed
Circuit
Gem-Jac
List:
45c

FROST-RADIO
No. 953
Open
Circuit
Gem-Jac
List:
40c

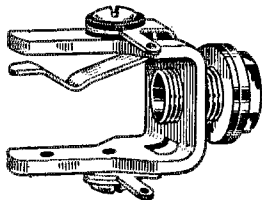

HERBERT H. FROST, Inc.
314-324 WEST SUPERIOR ST., CHICAGO
New York City Cleveland Kansas City
Los Angeles

Export Office: 314 W. Superior St., Chicago

EAGLE



All That's Best in Radio

Eagle Owners have the satisfaction of knowing they have the best Radio Receiver made, regardless of cost.

Ask Your Dealer



EAGLE RADIO COMPANY

16 Boyden Place Newark, N. J.

Let Us Supply

Your Transmitting and Receiving Equipment

AND BE ASSURED OF LATEST DESIGN AND HIGHEST GRADE WORKMANSHIP AND MATERIALS

BROADCAST MICROPHONES, INPUT AMPLIFIERS AND SPEECH AMPLIFIERS FOR ALL PURPOSES

CRYSTAL-CONTROL UNITS, CRYSTALS AND MOUNTINGS

FARADON CONDENSERS, WESTON AND JEWELL METERS, ETC.

COMPLETE COMMERCIAL AND AMATEUR TRANSMITTERS DESIGNED AND BUILT TO SPECIFICATIONS
LET US QUOTE ON YOUR REQUIREMENTS

W. P. HILLIARD & CO.

Arcade Building, Joliet, Ill.

Thordarson Equipped!

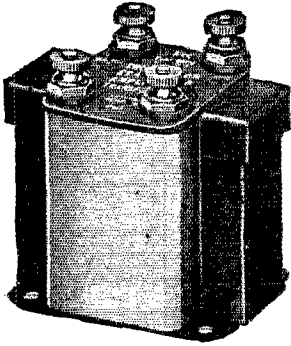

2:1 Ratio \$5.00
 3½:1 Ratio 4.00
 6:1 Ratio 4.50

Month after month, season after season, these leading receiving set makers continue to specify Thordarson Amplifying Transformers.

They have learned that Thordarsons will "stand the gaff"—that in tone quality they satisfy even the most fastidious—that even in hardest service they will not break down—that they are designed right, built right, and sound right.

Build or replace with Thordarsons.

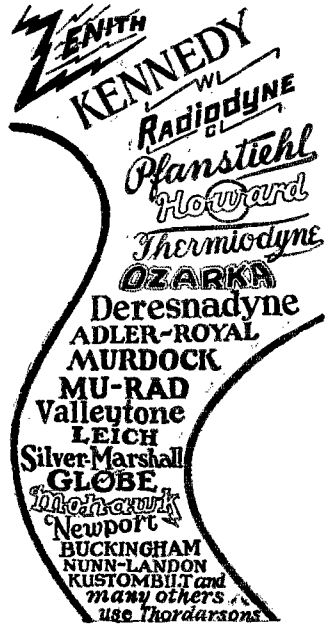

Write for Descriptive Circulars

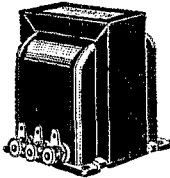

AUTOFORMER
 All frequency amplifier. Best base note reproducer made.
 Price, each \$5.00

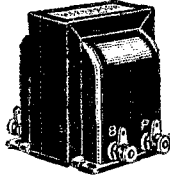

R-200 AMPLIFYING TRANSFORMER
 Super sized. Gives good musical reproduction.
 Price, each \$8.00

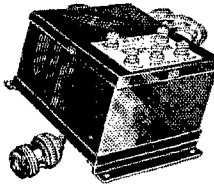

B-ELIMINATOR TRANSFORMERS
 For Raytheon Eliminators. Large capacity.
 Price, each \$7.00

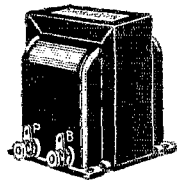

B-ELIMINATOR CHOKES
 30 henries, completely shielded. Capacity 60 milliamperes.
 Price, each \$5.00

THORDARSON

ELECTRIC MFG. CO.

Transformer Specialists Since 1895

World's Oldest and Largest Exclusive Transformer Makers

CHICAGO, U. S. A.

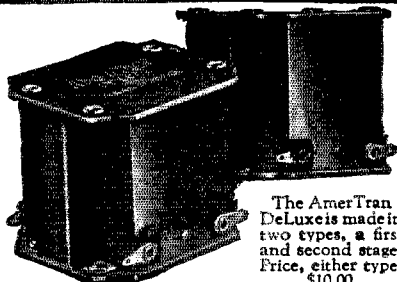

The AmerTran DeLux is made in two types, a first and second stage. Price, either type, \$10.00.

A New Standard of Excellence in Audio Amplification

The realism of this new audio transformer is outstanding. Realism of this kind results from the uniform amplification of the fundamental tones of the lower register. The AmerTran DeLux makes possible the natural reproduction of not only the Overtones, but all of the transmitted Fundamental tones.

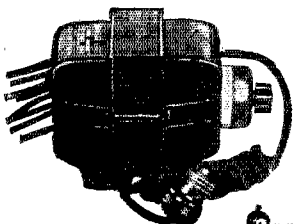

AmerTran Power Transformer type PF-45, Price \$15.00, type PF-52, Price \$18.00.

The AmerChoke type 854 is a choke coil or impedance of general utility. Price \$6.00.

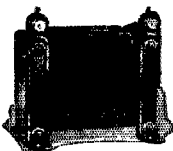

A Good Audio Amplifier

Requires enough plate and grid bias voltage on its tubes to prevent them from being overloaded by the signal voltage.

The AmerTran PF-45 or PF-52 with the half wave high voltage rectifying tubes now available and suitable condensers and resistances—together with three AmerChokes Type 854 will furnish these proper voltages. This combination will give real quality loudspeaker volume. AmerTran Power Transformers also supply A. C. filament current for the last audio tube.

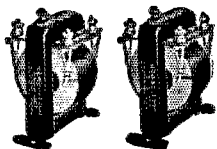

AmerTran Audio Transformers type AF6 (turn Ratio 5) and AF7 (turn ratio 3 1/2) are the leaders in their class. Price, either type, \$5.00.

Write for booklet describing these and other AmerTran Products—with recommendations on their use. It's free on request. All prices are F. O. B. Newark, N. J.

Sold Only at Authorized AmerTran Dealers.
AMERICAN TRANSFORMER CO.
 178 Emmet Street, Newark, N. J.

Transformer Builders for Over Twenty-Five Years

WANTED QUICKLY

FIVE COPIES
of the
DECEMBER, 1923
issue of
QST

WILL PAY
\$2
per copy

Write Carl Crouse,
 821 Monadnock Block Chicago, Ill.

RAJAH SOLDERLESS SNAP TERMINALS

Instantaneous in Operation—Positive Contact. For Panel, Ground and Battery Connections.



Patented—Sept. 23rd, 1924.

The Base Stud is tapped and furnished with 8-32 screw and washer. This fits all "B" Batteries with screw posts.

RAJAH
 Ground Connection

Used on TUNGAR, RECTIGON, PHILCO and EXIDE.

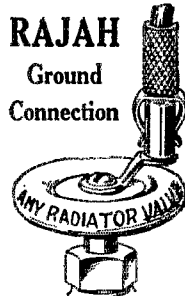

Terminal, complete, either style15c
 Extra Base Studs5c

RAJAH AUTO SUPPLY COMPANY
 Bloomfield, New Jersey

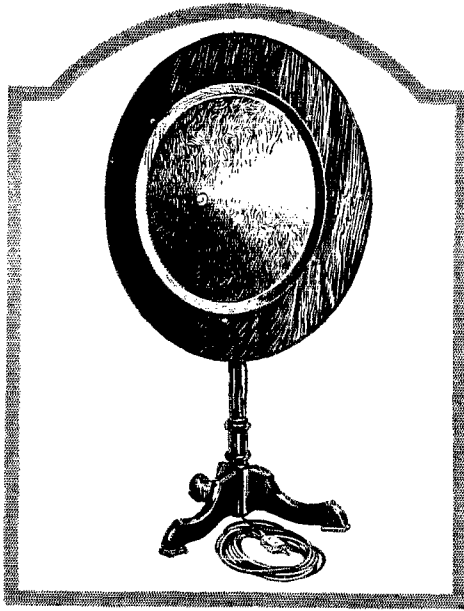

No. 5—A Cone Speaker. Tip-Top Table Type. Soundboard and pedestal finished in Mahogany. For any high grade receiver, 5 or more tubes, using semi-power tubes and 135 volts "B" battery. Equipped with plug and 20 foot cord. Prices: East of Rockies, \$35; Pacific Coast, \$40; Canada, \$49.

Licensed under Lektaphone patents 1271527 and 1271529. Other patents pending.

“The

Violin Soundboard”

To the epic achievement of Stromberg-Carlson's No. 601 Receiver is added that of their announcement of the New Cone Speaker. Produced after exhaustive research and experimentation, this speaker embodies an idea, old to Stradivarius and the other master creators of musical instruments, but new to radio—that of a *soundboard*.

The soundboard which functions the same on the new cone speaker as on a piano or violin—accomplishes the same purposes—that of giving true pitch and modulation to notes over the *entire* musical register. Whether it is reproducing the majestic roll of the organ, or the piping of the flute, this soundboard liberates the true beauty of intonation and phrasing which the music lover desires and appreciates.

By applying the principles of the soundboard to this new cone speaker, Stromberg-Carlson has united the old maestro's genius to the marvels of present day science.

Stromberg-Carlson Telephone Mfg., Co.
Rochester, N. Y.

Stromberg-Carlson

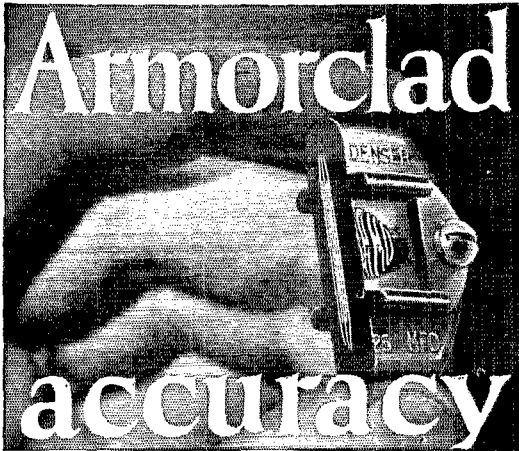

BE careful when choosing fixed condensers, if you want supreme results in radio. Look for permanent accuracy. These little valves must measure with perfect precision. If too much or too little energy is released at one time, the rest of the circuit chokes or starves.

SANGAMO Mica Condensers

are accurate—and they stay accurate forever, being molded in an armor of bakelite that gives complete protection against heat, cold, moisture, corrosive fumes, or accidental contacts with tools. Not a crevice in the armor into which moisture can creep, for the accuracy of a condenser can be utterly ruined by dampness absorbed from the atmosphere.

The sustained accuracy of Sangamo Condensers makes an immense difference in the tone, range, volume and selectivity of any well-built receiver. There is no finer looking or more accurate condenser on the market—that's why Sangamos are used by so many professional builders of radio sets.



6132-3

Approved by all nationally recognized radio laboratories

SANGAMO BY-PASS CONDENSERS

Surges won't break them down. Sizes to meet your requirements.

Sangamo Electric Company Springfield, Illinois

RADIO DIVISION, 50 Church Street, New York

SALES OFFICES—PRINCIPAL CITIES

For Canada—Sangamo Electric Co. of Canada, Ltd., Toronto.
For Europe—British Sangamo Co., Ponders End, Middlesex, Eng.
For Far East—Ashida Engineering Co., Osaka, Japan

Sent Prepaid Anywhere in the U.S.

Spaces Perfectly
\$7.50

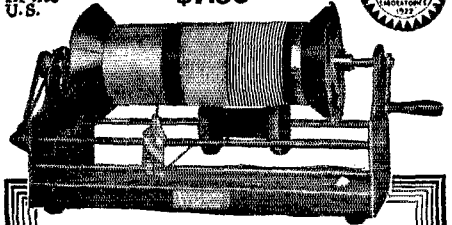

WIZARD WIRE WINDER

eliminates the most trying and difficult job in building sets. Saves hours in time and waste! Winds automatically and uniformly any thickness of silk, cotton and enameled wire into practically any style coil from 1/8 in. to 4 1/2 in. diam., and up to 10 1/2 in. long. Full instructions with each machine. Ready for instant use. Nickel plated throughout, strongly built.

Send No Money

we'll send you WIZARD C.O.D., or enclose \$7.50 with your order—either way we pay the postage. Wizard Wire Winder Co. 3812D Central Ave. Los Angeles, Calif. Dealers! Investigate!

Sold on an Absolute Money Back Guarantee

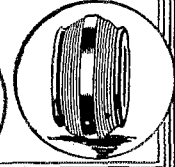
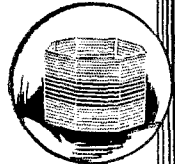
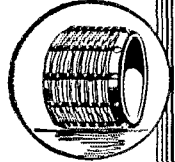

SEE THAT SCREW



A screw-driver adjusts an X-L in crowded places.

X-L VARIO DENSER

Results in easier tuning, more distance, volume and clarity—greater stability Indorsed by leading radio authorities.

Model "N"

A slight turn obtains correct tube oscillation on all tuned radio frequency circuits. Neutrodyne, Roberts two tube, Browning-Drake, McMurdo Silver's Knockout, etc., capacity range 1.8 to 20 micro-micro farads. Price \$1.00

Model "G"

with grid clips obtains the proper grid capacity on Cokaday circuits, filter and intermediate frequency tuning in heterodyne and positive grid bias in all sets. Capacity range .00018 to .00055 and .0003 to .001 micro farads. Price \$1.50

X-L Push Post

Push it down with your thumb, insert wire, remove pressure and wire is firmly held. Release instantly. Price 15c.

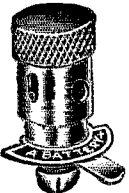

X-L RADIO LABORATORIES
2428 Lincoln Avenue N. Chicago, Ill.

The CUP WINNER

NEW YORK CITY NEW YORK LONDON CHICAGO BOSTON TORONTO SINGAPORE

DOUBLE DAY PUBLICATIONS
THE COUNTRY LIFE PRESS
GARDEN CITY, NEW YORK

1200 MADISON AVENUE
COUNTRY LIFE
GARDEN CITY, N.Y.
RADIO RECORDS, 121
WEST 57TH ST.
NEW YORK
THE COUNTRY LIFE PRESS
GARDEN CITY, N.Y.
1200 MADISON AVENUE
NEW YORK

Freud-Eisemann
Manhattan Drive
Brooklyn

WESTERN UNION TELEGRAM

RECEIVED AT 313 FULLON STREET, BROOKLYN, N.Y.

1935 FEB 14 7 52PM URGENT 5105 1/60

IN GARDEN CITY, N.Y. JAN 14 1935

FIELD BUREAU RADIO CITY
ATTENTION: R. R. SMITH, MANHATTAN DESIGN PLANT BLDG. # 1

ON THE OCCASION OF THE PRESERVATION OF THE SILVER CUP FOR THE
BEST RECEPTION OF A FOREIGN BROADCAST RECEIVED DURING THE
INTERNATIONAL RADIO BROADCAST TESTS FOR WIRELESS SHORT WAVE
RADIO BROADCASTS HELD AT RADIO CITY, NEW YORK, N.Y., ON JANUARY 14, 1935,
THE INTERNATIONAL TESTS WERE CONDUCTED BY RADIO BROADCAST
MAKING IN ADVANCE. THE RESULTS OF THE TESTS HAVE BEEN
INDICATED IN THE FOREWORD AND REPORT WHICH HAVE BEEN
AND THE ENTIRE RADIO LIBRARY FROM A COMPLETE UNDERSTANDING OF
THE COMING OF BROADCASTS TOGETHER AND INTERNATIONAL BROADCASTING HAS
MADE IT NECESSARY AND INTERESTING FOR US TO GIVE A THOUGHT TO
OUR INTERNATIONAL BROADCASTING TESTS.

WILLIS & WAGO RADIO BROADCAST
2157



PAUL C. VASEL
ROCKVILLE CENTER
NEW YORK

Mr. P. C. Vasel was awarded the silver cup for the best log. He used his **Freed-Eisemann NR-7** six-tube receiver.

International Broadcast
week record contest

Official confirmation by Double Day,
Page & Co., Publishers of Radio
Broadcast and other magazines.

FREED-EISEMANN



Pioneers— Now Leaders

Since B-Eliminators first attracted the eager experimenters Dongan has pioneered in the building of transformers and chokes. Today we are supplying leading manufacturers—and hundreds of fans too

TRANSFORMERS

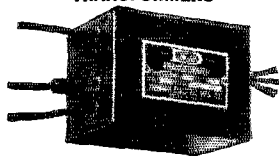

—with Dongan B-Power Units. Dongan B-Power Units are one of the most important factors in the operation and performance of Raytheon B-Eliminators.

Manufactured in 25, 30, 50 and 60 cycles.

- 509 Full Wave For Raytheon Tubes.
 - 537 Full Wave For UX 213 Tubes.
 - 538 Half Wave For UX216-B Tubes.
 - 561 For R.C.A. UX216-B Tubes.
- To be used with Power Amplifier Units.

CHOKES

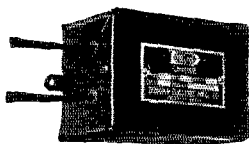

514 20 Henry at 70 Mil. \$6.00.
Specification 539
Choke is adapted for bridging across loud speaker.
Raytheon Tubes \$6.00.

FANS

Build your own B-Eliminators with Dongan B-Power Units— easily constructed and inexpensive.

If Your Dealer Cannot Supply
You Send Money Order Direct

Dongan Electric Manufacturing Co.

2999-3001 Franklin St., Detroit, Mich.

TRANSFORMERS of MERIT for FIFTEEN YEARS

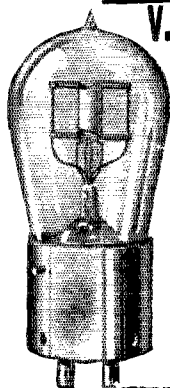

V.T.14 Transmitting Tubes

Rated at 5 Watts

(MFD BY GENERAL ELECTRIC CO.)
NEW, IN ORIGINAL CARTONS

Filament voltage 7½ Volts.
Filament current 1½ amps.
Normal Plate voltage 350 Volts.
Plate current 40 milli-amps.

Also Used as Power Amplifying Tube
STANDARD BASE

PRICE ONLY \$1.50
EA

American Sales Co.,
21 Warren St., N. Y. C.

TOAZ DUBBELUGS

May now be had in highest quality tinned stock in nominal lengths of 1, 2, 3, 4, 5 and 6 inches, corresponding to ¼, 1½, 2¾, 3½, 5 and 6¼ between holes.

**LET'S YOU BUILD
WITHOUT SOLDER**

**Price \$7.50 Per M
Nominal Inches**

SPECIAL PACKAGE

**Nominal 125 Inches
Any Assortment**

\$1.00 Net

Toaz Engineering and Sales Co.,
11703 Robertson Ave., Cleveland, Ohio.

FOR BETTER TUNING

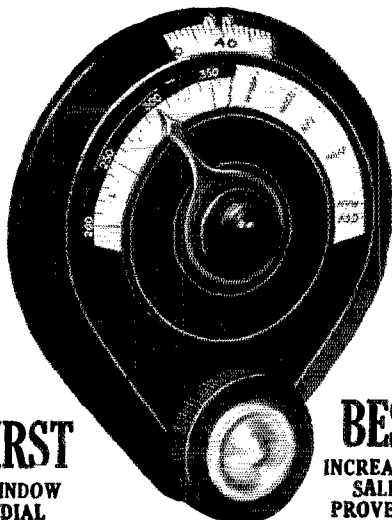

**FIRST
WINDOW
DIAL**

**BEST
INCREASING
SALES
PROVE IT**

Only dial that answers for condensers turning either way

BLACK AND GOLD FINISH \$2.50 BROWN AND GOLD FINISH \$3.50

BREMER-TULLY MFG. CO.
532 SO. CANAL ST., CHICAGO, ILL.

Cardwell

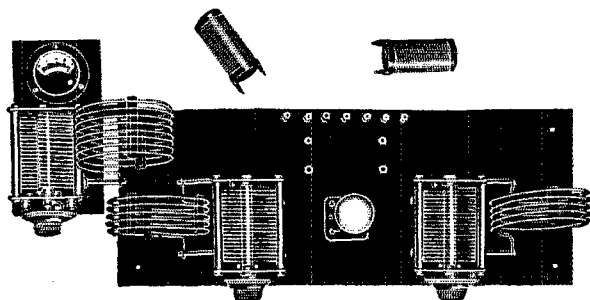

THE Tuned-Plate-Tuned-Grid Set which was the only transmitter to succeed in getting out of the Hotel Pennsylvania at the Second District Convention.

A folder gives complete constructional details. Write for it, giving your call letters.

2QA

To keep in closer touch with the amateur and his problems The Allen D. Cardwell Manufacturing Corporation has decided to go on the air with an experimental amateur station under the call of 2QA.

This station is expected to commence regular operation about the 25th of April, and will be glad to QSO any amateur stations. Experimental work will be undertaken on all amateur wave lengths, but regular schedules will be maintained in the 40 meter band.

One of the major reasons for establishing this station was to expedite the solution of many problems which require facilities and apparatus not available to many amateurs. With the well known Cardwell Laboratory

within easy reach, it is hoped that 2QA will be a source of real benefit to the amateur world.

Calls and letters from the amateur fraternity will be welcomed. Always give your call letters.

Cardwell radio instruments need no advertising, but for the convenience of users we have a thirty-six page hand-book and catalog giving many useful formulas and facts as well as prices of Cardwell products. A post card brings it.

**The Allen D. Cardwell
Manufacturing Corporation**
81 Prospect Street, Brooklyn, N. Y.



QST Low Power Transmitter. Cardwell Condensers specified, as always, because of their obvious superiority.

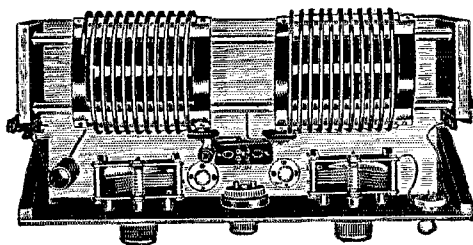

You are cordially invited to visit us at our booth at the Hudson Division Convention

Condensers



**LOW REL WAVE
PLUG-IN COILS**

For all low wave circuits. Cover every wavelength from 10 to 110 meters.

COMPLETE SET

Comprises 3 secondaries, 2 primaries, base and 2 flexible connectors.

PRICE \$4.50

Most short wave stations now use REL coils.

RADIO ENGINEERING LABORATORIES
27 Thames Street, New York, N. Y.

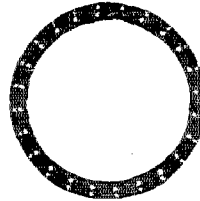

Patented Sept. 8th, 1925

Introducing the
**"CAGE ANTENNA
SPREADER"**
Diameter 7"

Provision has been made so that either a four, six or eight wire Cage Antenna System can be erected in less time, and with less effort than was ever before possible.

Price \$4.50 per dozen,

\$2.50 for a half dozen

No order accepted for less than one-half dozen. No stamps or C. O. D. orders accepted. Immediate delivery.

A descriptive circular, giving full details will be mailed upon request, and will also accompany each shipment.

CHARLES F. JACOBS

Radio 2EM, Pre War 2EE 279 Park Place, Brooklyn, N. Y.

To Our Readers Who Are Not A. R. R. L. Members

Wouldn't you like to become a member of the American Radio Relay League? We need you in this big organization of radio amateurs, the only amateur association that does things. From your reading of *QST* you have gained a knowledge of the nature of the League and what it does, and you have read its purposes as set forth on page 6 of every issue. We would like to have you become a full-fledged member and add your strength to ours in the things we are undertaking for Amateur Radio, and incidentally you will have the membership edition of *QST* delivered at your door each month. A convenient application form is printed below—clip it out and mail it today.

.....1926

American Radio Relay League,
Hartford, Conn., U. S. A.

Being genuinely interested in Amateur Radio, I hereby apply for membership in the American Radio Relay League, and enclose \$2.50 (\$3 in foreign countries) in payment of one year's dues. This entitles me to receive *QST* for the same period. Please begin my subscription with theissue. Mail my Certificate of Membership and send *QST* to the following name and address.

.....
.....
.....

Station call, if any

Grade Operator's license, if any

Radio Clubs of which a member

Do you know a friend who is also interested in Amateur Radio, whose name you might give us so we may write him about the League?

..... Thanks!

Contents of Acme B-Eliminator Kit

Wiring Diagrams with
complete instructions

Baseboard

- 1 Acme B-4—Transformer
- 2 Acme B-2—30 Henry Chokes
- 1 Acme Condenser Block
- 1 Bradleyohm
- 1 Raytheon Tube and Socket

Wire

Price 39.50

Photo below of factory-made Acme B-Eliminator Type E-1—110 Volts, 60 cycle—
Type E-2—110 Volts, DC \$20.00

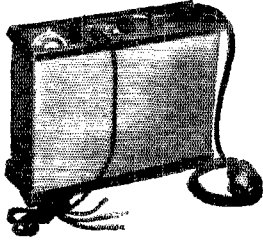

**Price
\$50.00**

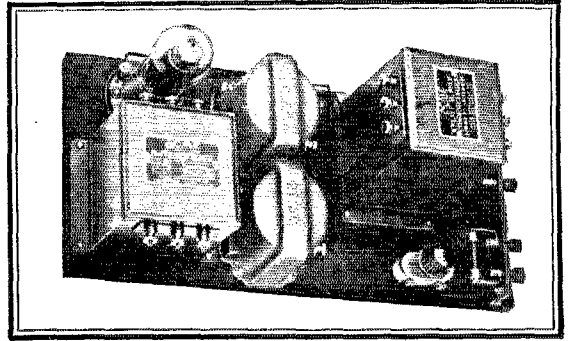

Acme B-Eliminator, assembled from Kit

You can easily make this Acme B-Eliminator yourself

*The new Acme B-Eliminator Kit contains
complete instructions and all the parts*

GET one of the new Acme B-Eliminator Kits—take it home and lay out the full size diagrams on the table in front of you. It takes only a few minutes to fasten the parts to the baseboard and connect them up. All the parts are there and the baseboard, too, and easily-followed instructions that explain each step. It's as easy as rolling off a log. You fellows who have tinkered with radio will do it in less time than it would take to tell about it.

Then you'll have an Acme B-Eliminator and save the difference between the cost of the Kit and a factory-built Acme B-Eliminator.

Advantages of the Acme B-Eliminator

You get better quality and more distance, more volume, and no hum and no distortion. You can be sure of that. Also the Acme B-Eliminator maintains its voltage at all times and you get voltages up to 180 volts which prevents any chance of over-

loading. It will supply sets using up to 10 tubes.

A permanent B-Supply

When you invest in an Acme B-Eliminator you get a permanent B-Supply. No more running out to get new B Batteries. There's nothing to wear out—the Raytheon Tube used has no filament to burn out and will last for thousands of hours—the current cost is practically nothing.

Send coupon for both booklet and circular

Send 10c for our booklet, "Amplification without Distortion" which will tell you some things about improving the quality of your radio reception, together with special free circular on the B-Eliminator Kit, or ask us to mail the free circular. Check the Coupon.

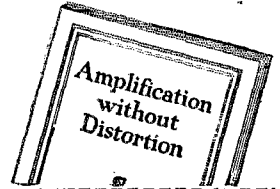

ACME APPARATUS COMPANY,
Dept. E16, Cambridge, Mass.

- I enclose 10c for copy of your booklet, "Amplification without Distortion" and circular on the B-Eliminator Kit.
- Please send only free circular on B-Eliminator Kit.

Name

Street

City State

ACME

~ for amplification

Radiohms and Potentiometers

Centralab non-inductive, variable resistances are controls of graphite type that insure smooth, noiseless tuning and permanent service. A single turn of the knob gives stepless variation of resistance from zero to maximum. Centralab Radiohms have two terminals, and can be furnished with maximum resistances of 2,000, 25,000, 50,000, 100,000 or 200,000 ohms. Centralab Potentiometers have three terminals, and are furnished in resistances of 400, 2,000 and 500,000 ohms. There is a type adapted to every radio circuit for control of oscillation or volume.

Write for literature describing these and other Centralab super-quality controls.

Central Radio Laboratories
20 Keefe Ave., Milwaukee, Wis.

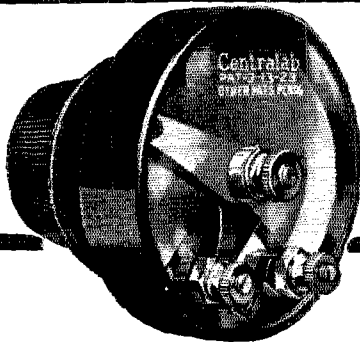

Centralab

TYPE SM 316 CONDENSER

SM Type 316 Condensers are furnished, all brass plates, die-cast frame and double adjustable cone bearings. May be ganged by placing one socket behind another, the shafts interlocking in any desired relation. SLF .00035 mfd. capacity for all types of SM. Interchangeable coils. Price \$5.75

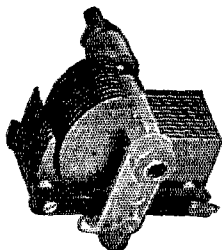

SEE Handle S-M Parts at your Dealers. Find out for yourself exactly why they are selected by experts and engineers.

SILVER-MARSHALL, Inc.
858 W. Jackson Blvd., Chicago

RADIO OPERATORS WANTED

Radio Operators are needed on board ships sailing for Europe, The Orient, Africa, South America, etc. THE EASTERN RADIO INSTITUTE can train you quickly and thoroughly because:

MODERN and EFFICIENT METHODS
THOROUGH yet Simple INSTRUCTION
New and UP-TO-DATE APPARATUS
THIRTEEN Years a RADIO SCHOOL

The OLDEST, LARGEST, and MOST SUCCESSFUL school in New England. RECOMMENDED BY THE A. R. R. L.

Day or Evening Classes Start Every Monday.
Write for Illustrated Prospectus

EASTERN RADIO INSTITUTE
899 BOYLSTON STREET
BOSTON, MASS.

Laboratory Product



**CRESCENT
LAVITE
RESISTANCES**

For Distortionless Amplification.

Insure distortionless amplifications and clarity of tone. Dual grid leaks for De Forest "H" tubes. \$3.50 each

Crescent Radio Supply Co., Liberty St., Jamaica, N. Y.

FILAMENT AND PLATE TYPES



Famous BH Transformers Transmitting Transformers

We specialize in the manufacture of transmitting transformers.

Write for Our Catalogue

Benjamin Hughes Electric Company
298 LaSalle Street St. W., Montreal, Can.
Transformer Builders Since 1910

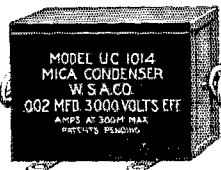

FARADON MICA CONDENSERS

.002 - 3000 VOLTS MODEL U. C. 1014

Used as Grid, Radio Frequency By-Pass, or Blocking Condenser. BRAND NEW IN ORIGINAL CARTON.

Our Special Price \$1.10 Ea.

AMERICAN SALES CO., 21 WARREN ST., N. Y. C.

PIEZO-ELECTRIC CRYSTALS

A NEW FIELD FOR THE EXPERIMENTER

Crystals cut to any practicable dimensions. Precise orientation with respect to electrical axes and piezo-electrical properties guaranteed.

QUARTZ SECTIONS FOR EXPERIMENTAL USE—

3/4" x 3/4", 0.50 to 5.00 mm. thickness—\$10.00.

JOHN T. ROONEY, Consulting Chemist.

31 Calumet Bldg., 52 W. Chippewa St., Buffalo, N. Y.

"Ten years of crystallographic experience"

THE JEWELL "TRIO"

Most Amateurs are using this Trio of Instruments Nos. 54, 64 and 74 on their Transmitting Sets.

Send for Jewell Literature for Amateurs. Order from Dealer.

JEWELL ELECTRICAL INSTRUMENT CO.
1650 Walnut St. - Chicago

"25 Years Making Good Instruments"

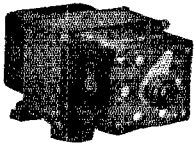

POWER TRANSFORMER, UP-1016.

Supplied with a winding for lighting the filaments, a winding for the plate source, and a winding for the KENOTRON filaments. Will operate 1 or 2 50-watt tubes. List, \$38.50. **OUR PRICE, \$11.50.**



RCA TRANSFORMERS

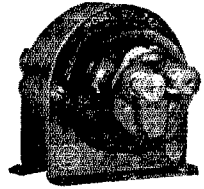

Audio Transformer, UV-712
Shielded in metal. Ratio 9/1. Useful frequency range, 60/3000 cycles. List, \$7.00. **OUR PRICE, \$1.00.**



Filament Transformer, UP-1658.
Output, 75 watts. Will operate 1 to 4 5-watt tubes. List, \$15.00. **OUR PRICE, \$5.50.**

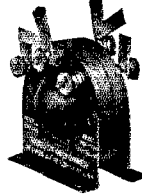

R. F. Transformer, UV-1714
Range 200 to 500 meters and 500 to 5000 meters, provided for by a tap on each winding. List, \$6.50. **OUR PRICE, 75c.**

Intermediate Wave Transformer UV-1716

The ideal transformer for superheterodynes.

Range 5000 to 25000 meters available without taps. List, \$8.50. **OUR PRICE, \$1.10.**

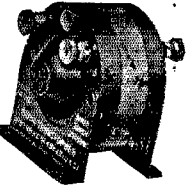

Oscillation Transformer UL-1008

May be used in any set-up using conductively coupled circuits. 25 turns of copper strip, nickel plated

mounted on a wooden base. List, \$11.00.

OUR PRICE, \$7.50.

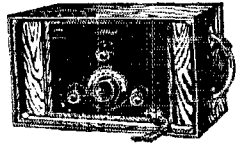
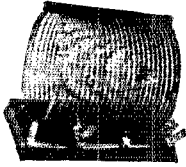

Federal Portable

A 4-tube set of unusual sensitivity, with mahogany cabinet. List, \$140.00. **OUR PRICE, \$30.00.**

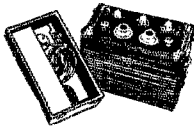

Kennedy Portable

A sturdy little 3-tube set, light and compact. Neat leatherette covered case. List, \$111.50 **SPECIAL, \$22.50.**

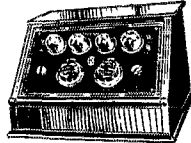

Kennedy 4-Tube

A surprisingly powerful set, in a cabinet of genuine mahogany, with gold-enraved sloping panel. List, \$105.00. **OUR PRICE, \$25.00.**

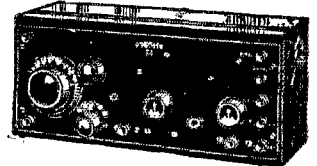

Crosley 3-Tube No. 52

Simple, compact, and effective. List, \$30.00. **OUR PRICE, \$9.50.**

Rectifying Tube

Can be used in any B-Eliminator. (Not a filament tube). A gas content tube made under a completely new design. Practically unlimited life. **PRICE, \$4.00.**



Federal Headset, 2200-Ohm

The product of 12 years of scientific experiment. List, \$7.00. **O U R PRICE, \$2.00.**

Lincoln 3-Circuit Tuner

Consists of tuner and condenser, operating individually from one dial. Will make a set with addition of one socket and rheostat. List, \$10.00. **OUR PRICE, \$1.95.**

Jewett Super-Speaker

Adjustable. Fibra horn. List, \$30.00. **O U R PRICE, \$9.75.**

Musicmaster Loudspeaker Unit

List, \$10.00. **OUR PRICE \$3.25**

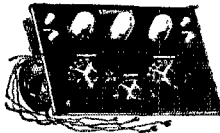

ECHOPHONE 3-tube CHASSIS

The same set that sold for \$50.00 in its cabinet. **O U R PRICE, \$7.75.**

Dictogrand Speaker

Adjustable; ebony finish. List, \$24.50. **OUR PRICE, \$6.75.** 6668.

King Cardwell Condenser .00035.

Dual condenser for control of R. F. sets with one dial. List, \$7.00. **OUR PRICE, \$1.95.**

Storage BATTERY. Genuine 100-amp. with 11 full-size plates. Guaranteed. **\$10.75.**

TUBES, Guaranteed, 201-A type, 55c.

BLUE TUBES, 201-A Type, 65c

Dongan Parts for Building B-Eliminator Transformers

No. 509. Full Wave; for Raytheon tubes.
No. 537. Full Wave; for UX-213 tubes.
No. 538. Half Wave; for UX-216-B tubes.
Our Price \$6.65

Chokes

No. 514. 20 henry.
No. 506. 30 henry.
No. 539. 50 henry.

Our Price, \$4.75

ANTENNA WIRE, No. 22, tinned copper, 7-strand, 100 ft., 75c.

EXTENSION CORDS, 20-ft. for loudspeaker, 45c.

5-WIRE BATTERY CABLES 45c

Q.S.T. Oscillating Crystals

NEW LOW PRICES

BROADCAST BAND

Crystal ground to your assigned frequency accurate to better than 1/10 of 1% for \$50.00. Prompt deliveries.

AMATEUR BANDS

We can furnish a crystal guaranteed to oscillate at some frequency in the bands with its frequency known accurate to 1/10 of 1% as follows:—

150	200	meter band	\$20.00
75	85	meter band	\$30.00
37	42	meter band	\$50.00

We can furnish a crystal to your specified frequency in other frequencies not listed above.

SCIENTIFIC RADIO SERVICE,

Box 86 Radio-3AJL MOUNT RAINIER, MD.

D. C. VOLTMETERS

0-500 VOLTS

MFD. BY GENERAL ELEC. CO.

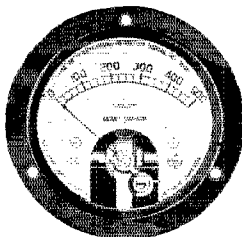

3 1/2" diameter shock proof case, zero adjuster located in the front.

Internal high resistance of 94 ohms per volt.

BRAND NEW IN ORIGINAL CARTONS

LIST PRICE \$22 EA

OUR PRICE

\$6⁵⁰ EA

AMERICAN SALES CO., 21 Warren St. N. Y. C.

A. R. R. L. APPARATUS

Essential equipment for every live amateur station

AMERICAN RADIO RELAY LEAGUE
LOG OF STATION

Sheet No. _____

DATE	CALLER	CALLED BY	NAME	ADDRESS	PHONE	REMARKS

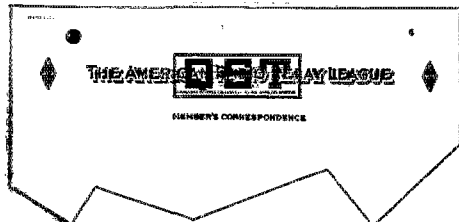

THE AMERICAN RADIO RELAY LEAGUE
HARTFORD, CONN., U. S. A.
RADIOGRAM

City of origin: _____ State: _____

To: _____

Address: _____

Back: _____ Sent: _____

THIS MESSAGE WAS RECEIVED BY THE AMATEUR STATION WHOSE ADDRESS APPEARS ON THE REVERSE SIDE (PLEASE FOLD THE OTHER SIDE)

MESSAGE DELIVERY CARD FOR
RADIOGRAM
BY
AMERICAN RADIO RELAY LEAGUE

From: _____ Date: _____

To: _____

At Radio Station: _____

THE AMERICAN RADIO RELAY LEAGUE IS A VOLUNTARY ORGANIZATION OF AMATEUR RADIO OPERATORS WHOSE INTEREST IS IN THE PROMOTION OF THE INTERESTS OF AMATEUR RADIO OPERATORS.

A. R. R. L. Log Sheets

Designed by hams for hams. 8 1/2 x 11 bond paper, punched for standard three-ring loose-leaf binder. 125 sheets postpaid for \$1.00 or 500 for \$3.50.

Members Correspondence Stationery

Write your radio letters on League letter-heads—it identifies you with the biggest radio organization in the world. Lithographed on 8 1/2 x 11 heavy bond paper. 100 sheets postpaid for 75c or 250 sheets for \$1.70. Sold to members only.

Official A. R. R. L. Message Blanks

Most convenient form. Designed by the Communications Department of the A. R. R. L. Well printed on good bond paper. Size 8 1/2 x 7 1/4. Put up in pads of 75 sheets. One pad postpaid for 30c or four pads for \$1.00.

Message Delivery Cards

Neatest, simplest way to deliver a message to a near-by town. On U. S. stamped postals 2c each. On plain cards (for Canada, etc.) 1c each postpaid.

American Radio Relay League, 1711 Park St., Hartford, Conn.

DON'T MISS IT, FELLOWS—EVERYBODY'S COMING!

**The First Annual
ATLANTIC DIVISION
A. R. R. L. CONVENTION**

**HOTEL LAFAYETTE
BUFFALO, N. Y.**



**JUNE 24, 25, 26,
1926**

**Technical Talks---Contests
Government Exams---Real
Short - Wave Dope**

**Special Illumination of
Niagara Falls
Banquet---Stunts---Fun**

SEND IN YOUR RESERVATION TO

**The Radio Association of Western N. Y.
598 Masten Street, Buffalo, N. Y.**

**When results are *vital*
“PYREX” insulation is used**

Reg. U. S. Pat. Off

The MacMillan 1925 Arctic Expedition depended on Pyrex insulation for sure radio transmission.

The Byrd 1926 Arctic Expedition is using Pyrex insulation on its transmitting and receiving sets

The Coast Guard Ice Patrol Service uses Pyrex antenna insulators.

The U. S. Lighthouse Service employs Pyrex insulators for signal and communication work.

The radio beacons of the Air Mail Service are equipped with Pyrex insulators.

Sixty broadcast stations have Pyrex insulators on their antennae.

To improve your signal strength use Pyrex insulators.

Catalog on request.

**CORNING GLASS WORKS
Industrial and Equipment Division
Corning - - - New York**

RADIO RESULTS—Just a Twist of the Switch!

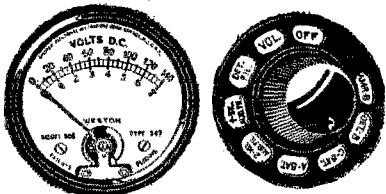

WESTON MODEL 506

Voltmeter and Universal Bi-Polar Switch

AN instantaneous and complete check-up on voltage conditions of your set—regardless of make or type!

Just a turn of the switch and filament and battery voltages appear on the dial of the double range voltmeter, (140-7 volts).

This new Weston instrument combination insures economical operation, and best results from the set.

Any leading radio dealer will show you the Weston 506 Voltmeter, and Universal Bi-Polar Switch Combination, or for further information address

WESTON ELECTRICAL INSTRUMENT CORPORATION
158 Weston Avenue, Newark, N. J.

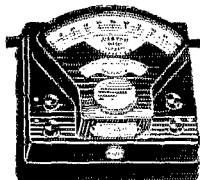

STANDARD THE WORLD OVER
WESTON

Pioneers since 1888

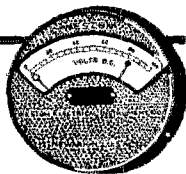

 If your radio does not do the music and the voices full justice it might be well to try a



\$14.75
CROSLY MUSICONE

Write Dept. 18 for Booklet
The Crosley Radio Corp., Cincinnati, O.

1 TUBE 5 TUBE
Crosley Radios \$9.75 to \$75

Prices slightly higher west of the Rockies

CARTER

All Metal "IMP" Rheostat

(PAT. PEND.)



HALF SIZE

All Resistances
3 to 50 Ohms

Same Size
Potentiometer
200 or 400 Ohms
\$1.25

"Hi-Ohm" Universal
Volume Control
500,000 Ohms \$2



Thousands of users have found this rheostat an unbelievable improvement. Small in size 1 1/2" dia. No moulded parts to break or crack. A contact arm that is positive yet works smoothly and without noise. Performs equally well on all circuits. Complete with knob.

Any dealer can supply

In Canada—Carter Radio Co., Limited, Toronto



"BREAKING IN" with QST's LOW POWER TRANSMITTER

Built in Accordance to Specifications Given in the April Issue of QST
by John M. Clayton, Ass't Technical Editor

COMPLETE KIT INCLUDES:

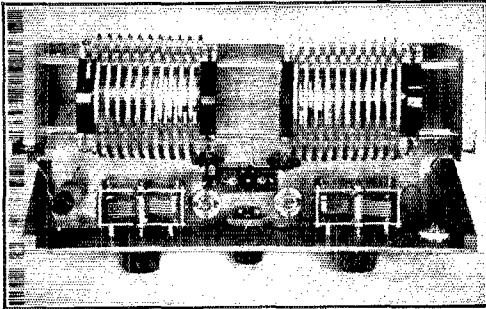

7 1/2 Watt Transmitter for 20, 40 and 80 Meters

The New REL Transmitting Inductance is Included in This Popular Set

Specially priced for sale to the amateurs **\$24.50**

See us at the Hudson Division A.R.R.L. Convention. This kit will be completely assembled at our booth.

RADIO ENGINEERING LABORATORIES

27 THAMES STREET

NEW YORK, N. Y.

- | | |
|--|--|
| <ul style="list-style-type: none"> 1—Maple Front Panel—drilled and engraved 2—Maple Panel supports 2—Maple Inductance supports 1—Maple Baseboard with grooved end pieces 1—REL Inductance—flatwise wound on glass. One primary and one secondary coil with two glass rods 2—Cardwell .00025 Mfd Variable Condensers 2—3 Inch Dials 1—2 ohm Amseco Power Rheostat | <ul style="list-style-type: none"> 1—REL Radio Frequency Choke Coil 1—REL UX Base Socket 1—4 Post engraved Binding Post Strip 1—2 Post engraved Binding Post Strip 1—5000 Ohm Lavite Grid Leak 1—.001 Sangamo Condenser 1—.002 Sangamo Condenser 3—Porcelain Miniature Lamp Sockets 1—3.5 volt Lamp 2—6 volt Lamps 2—lengths of Bus Bar 5—feet flexible rubber covered wire All necessary mounting screws |
|--|--|

Regular Price on These Parts When Purchased Individually \$35.00

GET THIS ^{10 DAY} FREE TRIAL INCREASE YOUR LOOP EFFICIENCY

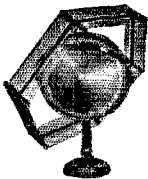
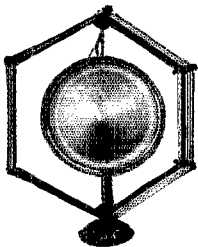

Vogue Cone Loop
\$37⁵⁰

Let us prove to you that the VOGUE UNIVERSAL CONE LOOP can greatly increase the efficiency of your Set without any risk on your part—if you don't like it, send it back.

UNIVERSAL CONE LOOP

The UNIVERSAL CONE LOOP has both horizontal and vertical action. Your reception is clear—interfering stations are cut out entirely.

Aim the LOOP the same as you would a gun—the truer your aim, the better your reception. Static can be reduced to a minimum, signal strength greatly increased—the best LOOP made for fine tuning. A \$30.00 standard make Cone Speaker is used.

Doesn't take up any more space than the regular Horn speaker—can't tip or fall—adjustable to every conceivable angle. If your Set isn't designed to work with an inside Loop, ask us how to change it over.

10 DAYS' FREE TRIAL

This offer is for a limited time only. Send check or money-order. If you aren't more than satisfied, return to us in ten days, and we will refund the full amount—provided, of course, the merchandise is received by us in good condition.

RICHARD T. DAVIS, INC.
5248 BROADWAY, CHICAGO, ILL.

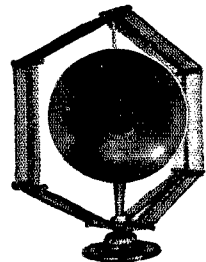

\$10⁰⁰

Vogue Horn Loop

Fits any regular Horn speaker—can be installed in a few seconds. No adjustments necessary—makes two units into one—fits snug around base of horn. 110 feet of 68 strand No. 36 silk covered wire used.

AIR COOLED

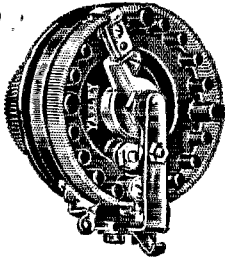

A marvel in design and construction! Coil air cooled, exposed on all sides. Adjustable contact sliding lever. No vernier required. One nut mounting.

All sizes from 2 to 100 ohms

Complete with knob, \$1.35

At all good radio dealers

YAXLEY

APPROVED RADIO PRODUCTS

YAXLEY MFG. CO., Dept. Q
9 So. Clinton St., Chicago, Ill.

There's Money in Commercial Radio

Our practical courses qualify you for Radio Operator, Mechanic, Dealer, etc. Home study or attend classes at our completely equipped school—arc, spark, and vacuum tube transmitters in operation.

Write Now for free booklet. **YMCA Radio Institute**
"OPPORTUNITIES IN RADIO" 159 East 86th Street
New York

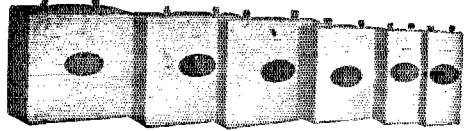

TORR Transmitting Condensers. Tested for voltage breakdown and capacity individually labeled with date of test. Capacities guaranteed within 5%.

Capacity Mfd.	SIZES AND PRICES	
	1000 Volts	2000 Volts
.1	\$1.10	\$2.25
.25	1.20	—
.5	1.40	3.25
1.0	1.75	4.50
2.0	2.85	7.50

We sell construction diagrams for all types of B Eliminators, Raytheon and Thermionic.
All parts for B Eliminators, condensers, chokes, transformers, sockets and resistances.

Send check or money order to
M. E. S. SALES COMPANY, Dept. A
23 School St., Boston, Mass.
Exclusive Radio Mail-Order Service

RARE GAS AND HIGH VACUUM PRODUCTS

Neon, Helium, Argon, etc.

We specialize in construction and development of all types of special thermionic valves, Neon glow lamps, Neon arc lamps, Mercury arc lamps, hot cathode and gas filled rectifiers, tubes utilizing the alkali and alkaline earth metals, and photo sensitive apparatus.

Also, high vacuum pumps, manifolds, etc., made of lead, lime glass or quartz glass. Special high frequency apparatus for electronic bombardment.

Flashlamps

1. Neon flash lamps for oscillographs, wavemeters, etc. Price \$3.50.
2. We are the makers of Hyvo—the really safe high voltage indicator.
3. Newest developments in photoelectric cells. Price \$15. Complete equipment for high vacuum work installed.

RADIO ELECTRICAL WORKS
Research Division, 23 Union Sq., New York, N.Y.

The A. R. R. L. Diamond Is the Emblem of a Real Amateur!



The League Emblem comes in four different forms. Its use by Members is endorsed and encouraged by the League. Every Member should be proud to display the insignia of his organization in every possible way.

THE PERSONAL EMBLEM. A handsome creation in extra-heavy rolled gold and black enamel, 2" high, supplied in lapel button or pin-back style. There are still a few fellows who are hiding their light under a bushel. Wear your emblem, OM, and take your proper place in the radio fraternity. Either style emblem, \$1.00, postpaid.

THE AUTOMOBILE EMBLEM. Will other hams know you when they meet you on the road this summer? Show 'em you're proud to be a ham. 5 x 2½", heavily enameled in gold and black on sheet metal, holes top and bottom, 50c each, postpaid.

THE EMBLEM CUT. A mounted printing electrotype, the same size as the lapel button, for use by Members in any type of printed matter, letterheads, cards, etc. \$1.00 each, postpaid.

THE "JUMBO" EMBLEM. You've taken care of yourself, your car and your printing. How about the shack wall or that 100-footer? Think of the attention this big gold-and-black enamel metal emblem will get! 19 x 8¼", same style as Automobile Emblem. \$1.25 each, postpaid.

Mail your order and remittance NOW to

The American Radio Relay League : : Hartford, Conn.

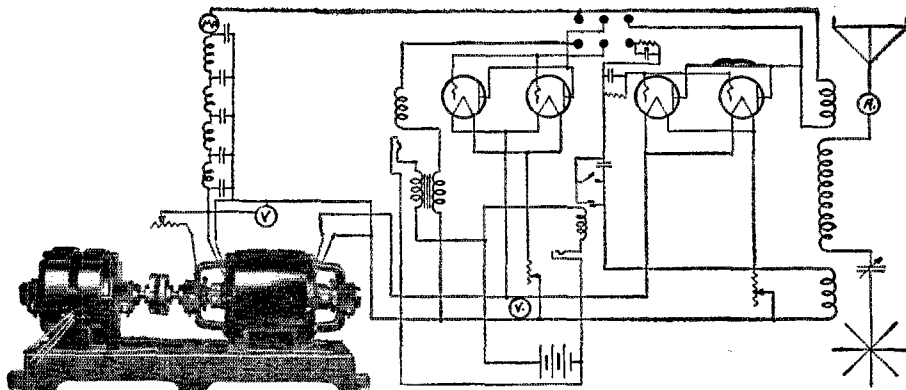

Item 37 2 unit four bearing set, delivering 1000 volts, 600 watts for plate and 12 volts, 300 watts for filament. The "ESCO" Set is shown here furnishing Power Supply for 4—50 watters in a phone or telegraph set. This is the Item used by CBZ8 in pioneer achievement of the first two way amateur wireless communication between North and South America.

ELECTRIC SPECIALTY COMPANY

Manufacturers of Motors, Generators, Motor-Generator Sets, Dynamotors and Rotary Converters for all radio purposes. Have you got your copy of Bulletin 237B and ESCO Filter facts? If not write for them.

TRADE "ESCO" MARK

225 South Street

Stamford, Conn., U. S. A.

"ESCO" Engineers will help you solve that Generator problem

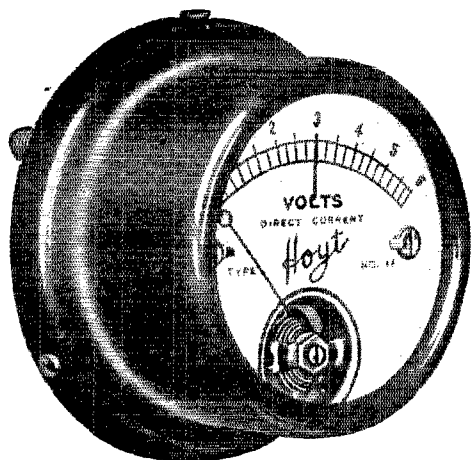

Hoyt 2" Type 17 Front of Panel Mounting
Voltmeter
(Shown full size)

Hoyt

Type 17 Meters Front of Panel Mounting

The Hoyt Type 17 Precision Moving-Coil Voltmeters, Ammeters and Milliammeters for Radio are now built in FRONT of PANEL MOUNTING cases. They are only 2" in diameter, with hand-calibrated scales, of simple and pleasing appearance, and are very easily mounted by drilling two small holes in the Bakelite or hard rubber panel. They project no more from the panel than a condenser-dial, and are recommended especially for amateurs.

Standard Ranges

0-6, 0-10, 0-150, 0-200 VOLTS
0-15, 0-25, 0-50 MILAMPERES
0-7.5 AMPERES

PRICE STANDARD BLACK FINISH (without multipliers) \$7.00
Also made in 2 ranges and special scales at slightly greater prices

BURTON - ROGERS - COMPANY

26 Brighton Ave., Boston, Mass.

National Distributors

Send for Book B "Hoyt Meters for Radio"

Gross Short-Wave Plug-in Coils

General Radio Jacks and Plugs used. Most efficient plug in arrangement on the market.

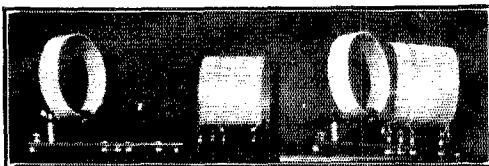

Minimum amount of dielectric insures lower losses resulting in stronger signals and sharper tuning.

Can be handled freely without fear of injuring coils, also making possible permanent calibration of set.

Price for 80 Meter Band complete with Base (58 to 115 meters) \$5.50.

Price for 40 Meter Band (30 to 60 meters) \$5.50. Complete with Base.

Separate coils only for 20, 40, or 80 meters \$3.00.

Without question the most rugged receiving coil on the market.

Spaced winding insuring minimum distributed capacity.

GROSS WAVEMETER

Built into neat cabinet. Range 20 to 200 meters. Low Loss inductances and condensers insure a low resistance wavemeter. Accurate calibration checked against crystals. Can be used with both receiving and transmitting sets.

PRICE WITH FLASH LAMP \$18.75

PRICE WITH GALVANOMETER \$33.75

The original short wave Pancake inductance Transmitting 20, 40 or 80 meters \$6.00. Quartz Crystals \$6.75.

Transmitters—anything from a peanut tube to a 1000 watt installation. Send stamp for circulars describing complete line of short wave transmitting and receiving apparatus manufactured.

J. Gross & Co.

907 Fox Street

Bronx, N. Y., City

Laboratory, 74 Dey Street

"FOR SALE"

"75-Mil Henry Inductance"

Made by International Radio Telegraph Co., Pittsburgh, Pa.

AT ATTRACTIVE PRICES

Also:

Armatures, Buzzers, Coils, Elements, Storage Batteries, Generators, Hydrometers, Insulators, Sets, Switches, Transformers, Voltmeters, Panels, and Headsets.

U. S. Signal Corps Material can be inspected in New York. Write, Wire or Phone.

SUPREME SUPPLIES COMPANY, Inc.

150 Nassau Street, New York City
Beekman 7280

Amateurs! ← Amrad "S" Tubes

Type 4000-1

Now in stock—\$10.00 each, sent Parcel Post—C. O. D. and charges.

Thomas Martindale & Co.
25 N 10th St. 926 Filbert St.
PHILADELPHIA, PA.

Faradon



MODEL T All-Metal-Mica Condensers
For Receiving Sets

Also **Faradon** For

By-Pass, Filter, Blocking
and
Interference elimination
applications

Complete data and quotations furnished promptly upon receipt of advice as to requirements.

19 Years Specialization in the Radio Field
See our exhibit at the Hudson Division Convention.

Wireless Specialty Apparatus Co.
JAMAICA PLAIN, BOSTON, MASS., U. S. A.
ELECTROSTATIC CONDENSERS FOR ALL PURPOSES

A BETTER AND DIFFERENT PLUG-IN COIL

Note its advantages listed below—and try and do without it!

1. Positive contact is secured through General Radio plugs and jacks.

2. With 3 Coils, continuous, gapless range is secured from 140 to 16 meters. One of the 20-40-80 meters amateur bands is located in the middle of the tuning range of each of the 3 coils. (For this a SFL Condenser, 140 mmfd. max. cap. is essential.)

3. Operation of regeneration condenser has no effect on the tuning; the 2 controls are completely independent.

4. Antenna coupling is adjustable; by a primary coil

and not through a condenser. Secondary coils are specially constructed so that setting of primary coil does not need to be changed when secondaries are exchanged.

5. Coils are space-wound solenoids on skeleton frames.

6. Both tickler and antenna coil are at filament end of the secondary.

7. These coils cover the 3 U. S. Amateur Bands, all European Amateur Bands, Short-Wave Broadcast, U. S. Naval and Commercial Short-Wave Stations, etc.

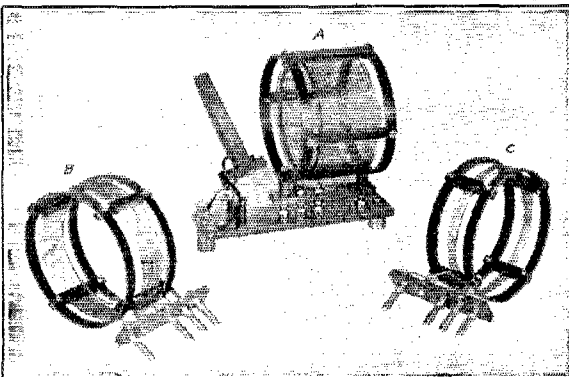

The Kit Illustrated Covering 15 to 133 Meters Complete **\$12.50**

Coll. No. 4, 125-250 M

Price \$4.00

Coll. No. 5, 235-350 M

Price \$4.00

These coils are essential to the most efficient operation of your station. Order your TODAY.

AERO PRODUCTS INCORPORATED, Dept. 16, 1768-1772 Wilson Ave., Chicago, Ill.

THE SUPER-SYNC

The Synchronous Rectifier That Can Be Filtered

The Super-Sync is the only synchronous rectifier that can be filtered with ordinary type of filter. Tests show that it will stand up under constant use requiring very little attention.

When filtered the Super delivers a pure, direct current which is often mistaken for battery plate supply.

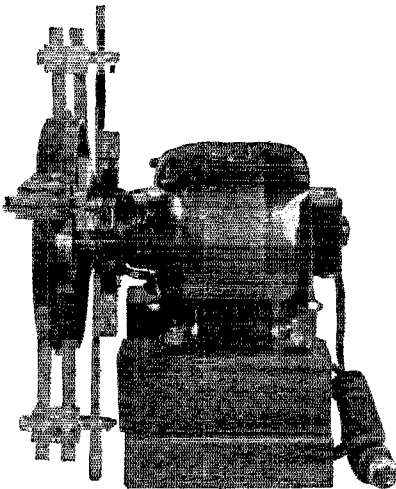

The Super Sync is rated at 4000 volts 250 M.A. This is usually sufficient to supply the average amateur transmitter.

The commutator on the Super is eight inches in diameter and is driven at a synchronous speed by a $\frac{1}{4}$ H. P. motor. This motor can be supplied for either 110 or 220 volts 50 or 60 cy.

PAT. PENDING

PRICE \$75.00 F. O. B. ST. LOUIS

MARLO ELECTRIC CO., 5241 Botanical Ave., St. Louis, Mo.

HAM-ADS NOTICE

Effective with the July, 1926 issue of *QST* the policy of the "Ham Ad" Department will be altered to conform more nearly to what it was originally intended that this department should be. It will be conducted strictly as a service to the members of the American Radio Relay League, and advertisements will be accepted under the following conditions.

(1) "Ham Ad" advertising will be accepted only from members of the American Radio Relay League.

(2) The signature of the advertisement must be the name of the individual member or his officially assigned call.

(3) Only one advertisement from an individual can be accepted for any issue of *QST*, and the advertisement must not exceed 100 words.

(4) Advertising shall be of a nature of interest to radio amateurs or experimenters in their pursuance of the art.

(5) No display of any character will be accepted, nor can any typographical arrangement, such as all capital letters, be used which would tend to make one advertisement stand out from the others.

(6) Contracts for "Ham Ad" advertising which are now in force, and which have until later than July, 1926, to run, will be completed in accordance with the understanding under which they were made, but cannot be renewed.

(7) No new contracts will be made for "Ham Ad" advertising after March 20, 1926.

(8) The "Ham Ad" rate will be 7c per word, and remittance for full amount must accompany copy.

(9) Closing date remains as heretofore; the 25th of second month preceding date of publication.

(10) This notice will be published in the May and June, 1926 issues of *QST*.

TELEGRAPHY—Morse and Wireless—taught at home in half usual time and at trifling cost. Omnigraph Automatic Transmitter will send on Sounder or Buzzer unlimited messages, any speed, just as expert operator would. Adopted by U. S. Govt. and used by leading Universities, Colleges, Technical and Telegraph Schools, throughout U. S. Catalog free. Omnigraph Mfg. Co., 13M Hudson St., New York.

MOTORS—New G. E. $\frac{1}{4}$ HP \$12.50, $\frac{1}{2}$ HP \$28.50, 1 HP \$45. **GENERATORS**—Radio Transmission 500V \$28.50. **Battery Chargers**—Farm Lighting generators all sizes. Lathes, Drill Presses, Air Pumps other Garage and Shop equipment. Wholesale Prices. New Catalog. **MOTOR SPECIALTIES CO.**, Crafton, Penna.

"The Hawley." An alkali un-acid rechargeable "B" storage Battery of 22 $\frac{1}{2}$ volts. Not an unassembled battery but ready to use—no extra parts to buy. Uses the largest sized tested Alkaline elements (Edison). Heavy cased top glass cells. Chemical electrolyte included and shipped separate. Any detector or amplifying voltage easily had. Special offer. 4-22 $\frac{1}{2}$ volts (90 volts) \$10.00; 112 $\frac{1}{2}$ volts \$12.50; 135 volts \$14.75; 157 $\frac{1}{2}$ volts \$16.80. For those wishing to put their own together buy the knock-down kits. Put up in all voltages at still greater savings in price. The only battery of its kind sold on a 30 days trial with complete guaranteed satisfaction or your money returned in full without any ifs, ands, or buts. Further guaranteed 2 years. Order direct—send no money. Simply pay expressman its cost plus the small carrying charges. Patent pending. Same day shipments. Write for my guarantee testimonials and literature. It's free and it's interesting. Complete sample cell 35c prepaid. B. Q. Smith, 31 Washington Ave., Danbury, Conn.

WHO'S SMZS? International Amateur Radio Call Book tells you. See hamad below.

MORE THAN THREE THOUSAND FOREIGN CALLS IN OVER THIRTY COUNTRIES: Canada, England, South Africa, Philippines—all others except U. S. The International Call Book Co., Drawer 205, Station "A", Hartford, Conn., sells it for fifty cents. Copy mailed day order received. No C.O.D. Please don't send stamps; we have a million already.

EXCHANGE—What NEW RECEIVING parts do you want? Can use perfect, latest model RECEIVING parts, in new condition, in exchange. No sets. **RADIO EXCHANGE, KENT, OHIO.**

EVERYTHING in RECEIVING apparatus. 25% discount to "hams". Over 2 pounds data, catalog, etc.—prepaid—25c. Kladag Laboratories, Kent, Ohio.

Jewell Meters, 20% discount. Acme transmitting and receiving apparatus, National transmitting and receiving condensers, with type A and B velvet vernier dials. Genuine Nathaniel Baldwin phones and speakers. Philco A and B batteries and battery eliminators. Tobe Deutschmann condensers. 12 and 14 enameled wire. Margnet wire, Bakelite panels, rods and tubing, all sizes. Victoreen Super Heterodyne Kits are the last word in supers. Some RCA apparatus left. Bulb type chargers, special. Rectigon bulbs, Amrad S Tubes. Also Hydrometers, Keys, Buzzers, Omnigraphs, Celatsite Wire, insulators, amperites, German litz wire, Yaxley and Centralab products. Be sure to get the new National Type B velvet vernier dial. We allow discounts to A. R. E. L. members and dealers only. Give your call letters. Write us when you need anything. We carry it in stock. Roy C. Stage, Wholesale Radio, Montgomery & Burt Sts., Syracuse, N. Y.

WHAT ARE YOU FEEDING YOUR SET, THE PURE STUFF OR POISON BOOTLEG? READ FEBRUARY QST PAGE 23 AGAIN, LET IT SINK IN, THEN ORDER A STEEL ALKALINE LIFETIME EDISON B. (THE 8 ML KIND). NOT SLAPPED TOGETHER BY KIDS OR GUM-CHEWING TESSIES. NO JOINTS—ELECTRICALLY WELDED FOR ABSOLUTE QUIET. 54 VOLT \$8.25, 100 VOLT \$15.00. OTHER SIZES, OAK CABINET, RUBBER MAT. LARGEST ELEMENTS. REAL EDISON SOLUTION. A BIG BEAR OF A B—2000 MLIAMP HOUR FOR THE MULTITUBE SET. 105 VOLTS \$24.00. ASSEMBLED CELLS 24c. SAMPLE 30c. QUANTITY DISCOUNTS. PEPPY EDISON A ELEMENTS 5c. WELDED PARTS 74c. GIANT SUPERCCELL 4000 MLIAMP HOUR 40c. SAMPLE 50c. GET SET OF THREE FOR YOUR 199. ANNEALED TEST TUBES $\frac{3}{8}$ " x 6"—8c, 1"—4c. SHOCKPROOF JARS 1" x 6"—4c, 1 $\frac{1}{4}$ " x 6 $\frac{1}{2}$ "—5c. PUREST SOFT .032 NICKEL 1c ft., .034 (HEAVY) 14c FT. RUBBER SEPARATORS $\frac{1}{2}$ c. REAL EDISON ELECTROLYTE (THAT'S NO LYE) LITHIUM COMPOUND \$1.25 MAKES 5 LBS. WILLARD COLLOID. A REAL B CHARGER \$2.00. JUMBO \$3.00 (PULLWAVE USE 2). BRING YOUR AERIAL UP TO QST SPECIFICATIONS WITH NO. 12 SOLID COPPER ENAMEL AERIAL WIRE, 75c 100 ft. FOR A PERMANENTLY PERFECT AERIAL PYREX INSULATORS. LEAD-IN BOWL TYPE PYREX \$1.50. PRESCRIPTIONS FOR ALL AILING B'S.

FRANK M. J. MURPHY
4337 Rockwood Road
CLEVELAND, OHIO

FOR A GOOD NOTE AND GOOD DX

General Electric 24/1500 volt 288 ampere 6000 RPM 112 segments unused \$45. Slightly used \$25. IDEAL FOR BATTERY PLANTS. \$3 additional for belt drive. Use any speed motor. Results equally as satisfactory. Crocker-Wheeler 24/1500 volts 450 watts \$45.00. GE 12/350 volts 148 mills and Holzer-Cabot 12/500 volts 70 mills \$18. All ball bearing machines. Navy Keys with Blinker light. \$2.00 Crocker-Wheeler 500 cycle motor generators. Ship to any part of globe. Henry Kienzle, 501 East 84th Street, New York.

URECO 7½ WATERS GUARANTEED \$6.60. G. E. Hot wire ammeters, \$1.50. One (1) power transformer (ACME) Two filament windings NEW \$15.95. LOW POWER TRANSMITTERS—C.W. or phone built to order. Send us your requirements. LAING & BOWDRE, RADIO 9DBN, 209 RICHMOND STREET, JOLIET, ILLINOIS.

SELL "S" tubes, sockets. Thomas Wildman, Nichols, Iowa.

GREBE 13—give offer. Harry Biederman, Osseo, Minnesota.

SLIGHTLY used Murad MA-15 six tube receiver and new Magnavox TRF-5 receiver with new M-4 Magnavox re-producer must absolutely be sold regardless of price. No reasonable offer refused. Palmer Craig, Physics Department, University of Cincinnati, Cincinnati, Ohio.

Reg. U. S. RKUMA YRLSBUG, Pat Off. DODGE RADIO SHORTKUT with APPENDIX and HELPFUL HINTS FOR BETTER KEY WORK. Kills Hesitation in Reading Transmitted Code. Cultivates and Develops Legible Transmission.

Will fix Code Signals in mind to Stick. QUICK GAIN IN RECEIVING SPEED Reported by 9BYL Hammond, Ind. Speed was 10; now 18. Did it quickly.

9CHEM Le Mars, Iowa. Speed 7; now 15. Spare time few days.

9DMK Fond du Lac, Wis. Speed 8; now 15. Few days only.

9KM Kansas City, Kans. Doubled speed plus in few days.

9BKX New Ulm, Minn. Shortkut helped me speed up quick.

9CSK Carrier Mills, Ills. In two hours good increase.

9ASP Redfield, S.D. Speed 10; now all can hear clearly.

9CMW Hickman, Ky. Speed 15; now 25. Attention 3 evenings.

9BNT Creston, Iowa. Speed 8; now 20 and did it quick.

9BUQ Mentone, Iowa. Speed 4; now 10. After once reading above reports; 200 others; quarter coupon; 25 cents (or cts).

SHORTKUT; Appendix; Key Work; Reports \$3.50 KEY WORK; Appendix; Reports; \$1.50 No COD's REGISTERED mail del'y—Send MONEY ORDER DODGE RADIO SHORTKUT, MAMARONECK, N. Y.

BARGAINS—New Acme 600 watt transformer \$23.50. 200 watt \$16.00, used \$10.00. DeForest H. Tube like new \$13.00. UP1627 Filter Reactors 300 mills new \$10.00. R. Burrows, 3107 Durbin Pl., Cincinnati, Ohio, 8AMT

BRASS ribbon for pancake Helices for 20-40-80 meters; ¾" wide, .064" thick, 6c foot, 30 foot lots, 7c foot for less. Prepaid to 4th zone, 1c foot more beyond. Geo. Schulz, Calumet, Michigan.

Why do Hams from every civilized country on the globe order from 9ALD? The answer is simple: our service and goods are unexcelled. East, north, south, west, the foreign orders roll in. If you have never ordered from us before, try it and find out why for yourself. WE MAKE EDGEWISE WOUND COPPER STRIP, 1/16"x¾", wound 6" inside diameter, 12c per turn. 4" 10c, straight strip 5c per foot; ALSO THAT PHOSPHOR BRONZE INDUCTANCE CLIP (SEE JANUARY QST, PAGE 27), 20c EACH; Genuina Beldenamel antenna wire, best obtainable. Note new method of pricing, postage prepaid on all antenna wire to any point, up to 25% of value. No. 12, \$1.00 per 100'; No. 14 65c per 100'; 7x22 stranded enameled \$1.05 per 100'; Pyrex 7¼" insulators \$1.50, 12¼" \$3.50, 6" lead-in bowl \$1.50; Sure Fire 20" porcelain insulator \$1.00; Pindlay 6" stand-off insulator 50c; WARD-LEONARD 5000 OHM GRID LEAKS, CAPACITY 200 MILLIAMPERES, GOOD FOR 500 WATTS OR MORE. \$2.00; Radioleak, variable transmitting grid leak, high enough resistance for DeForest H tube, \$5.00; Ward-Leonard 2500 ohm grid leaks, 80c; 4000 ohm, 95c. SAY YOU SAW IT IN QST—IT IDENTIFIES YOU AND HELPS QST

Radiostat, primary filament rheostat \$6.50; Acme 2 mfd 2000 volt filter condensers \$6.50, 2 mfd. 750 volts \$2.50; Acme .0001 mfd. variable transmitting condenser \$5.50; Acme chokes and transformers, all sizes in stock. NATIONAL TRANSMITTING AND RECEIVING CONDENSERS, ALL TYPES. 50 watt tube sockets, \$2.50; Pyrex sockets for UX tubes 70c; Fleron porcelain socket 65c; Erla 1000 cycle audio transformer \$6.50; Thordarson 450 watt plate transformer \$18.00, 100 watt \$13.00; 150 watt filament transformer \$10.00, 80 watt \$7.00; special plate and filament transformer for one 5 or 7½ watter, \$7.50. CITIZENS CALL BOOKS, AMATEUR EDITION 75c, broadcast 50c. BALLANTINE'S RADIO TELEPHONY FOR AMATEURS \$2.00 Raytheon tubes and B-eliminators parts. HAVE SOME MORE RCA O-5 HOT-WIRE AMMETERS \$1.25, former list price \$6.50. WE RENT OMNIGRAPHS, SEND FOR TERMS. EVERY HAM SHOULD HAVE A COPY OF OUR NEW "HAMALOG". Have you yours? Include postage on your orders please, with exception of antenna wire. E. F. JOHNSON, 9ALD, Waseca, Minnesota.

EDISON ELEMENT STORAGE "B" BATTERIES AND PARTS IN STOCK FOR IMMEDIATE SHIPMENT. REASONABLE PRICES. SEND FOR COMPLETE LIST. J. ZIED, 904 N. 5th ST., PHILA., PA.

\$12.50 Marconi hand driven C. W. magneto generators, 2500 rpm. Can be adapted to C. W. We have \$10,000. worth of United States Government Aircraft Department Radio Transmitting Receiving Sets and Parts. Get our new and latest reduced price list. Send stamp for list. Mail orders answered all over the world. WEIL'S CURIOSITY Shop, 20 South 2nd St. Philadelphia, Pa.

ROICE 5-WATT DX BABIES \$3.15 postpaid. WESTERN ELECTRIC 50-WATERS \$16.50. CURTIS-GRIFFITH, FORT WORTH.

Special motor generator bargains. New motor generator sets at less than secondhand prices. We have in stock a few New Westinghouse double commutator 750 V. 200 W. D. C. generators direct connected to 110 V. 60 cycle A. C. motors \$45.00 each. Field rheostat extra \$4.50 each. 25% with order, balance C. O. D. express inspection allowed. Subject to prior sale. QUEEN CITY ELECTRIC CO., 1734 GRAND AV., CHICAGO, ILL.

FOR SALE—complete 50 watt transmitter, write for particulars. 9CKH.

SPECIAL FOR LOW WAVES, fifty watt A tubes with heavy grid lead, \$20.00 prepaid, cash or C. O. D. Wilbur E. Gemmill, 101 Fourteenth St., Troy, N. Y., 3AAO.

HAMS. A PENNY FOR YOUR THOUGHTS, IS A TRITE EXPRESSION, "BUT" TWO PENNIES ON A POSTAL CARD ASKING FOR PRICE LIST OF TRANSMITTING PARTS, WILL PROVE TO BE A MONEY SAVER. FOR INSTANCE, PLUG IN COILS ARE QUITE TROUBLESOME TO BUILD, UNLESS YOU HAVE SOME GENERAL RADIO COIL MOUNTING ACCESSORIES. THEY ARE ADAPTABLE TO ANY TYPE OF COIL, SEND YOUR QRA TO THE ONLY HAM STORE IN THE FIFTH DISTRICT. FORT WORTH RADIO SUPPLY CO. FORT WORTH, TEXAS.

THREE element chemical rectifiers—1 takes the place of 2 jars, or use both sides of A. C. in same jar 99.7% aluminum electrodes ¼"x¼" rubber cover, pint jars 3" inside diameter, sample 75 cents plus postage on 2 lbs; dozen lots 60 cents each plus express on 15 lbs. Ready for delivery May 15th. Cash with order, satisfaction or money back. Pure ammonium phosphate, the best chemical for Rectifiers, \$1.15 lb. prepaid enough for 12 jars. Geo. Schultz, Calumet, Michigan.

QST! HAMS PREPARE FOR SUMMER DX! IMPROVE YOUR STATION WITH AMATEUR RADIO 'SPECIAL-TIES'. PANCAKE COUPLED INDUCTANCE wound with heavy brass on kiln dried maplewood—absolutely No-loss—maximum energy transfer—20 and forty meter sizes \$5.45—80 meter size \$5.95. Cardwell double spaced transmitting condensers—will withstand 3,000 voltflash-over test—just the thing for primary or series circuit—.00025 MFD SPECIAL \$3.95. Acme mounted modulation transformers \$4.95. Fleron 8 inch glazed porcelain strain insulators \$.50. Ward Leonard 5,000 ohm grid leak (100 millamp capacity) \$1.90. Allen-Bradley Radiostats large, \$6.45, small (E-210) \$3.85. Bakelite panels 18x14x¼ inches \$3.50. OUR STANDARD SHORT WAVE RECEIVER HAS NO COMPETITION IN REGARD TO EFFICIENCY, WORKMANSHIP AND PRICE. BUILT WITH THE BEST APPARATUS AVAILABLE. USES THE FAMOUS R. E. L. PLUG-IN COILS, HAMMAR-

LUND (ISOLANTITE INSULATED) S. L. F. CONDENSERS, MARCO DIALS, BENJAMIN SHOCK ABSORBING SOCKETS, SANGAMO FIXED CONDENSERS, RADION PANEL, SUBPANEL AND BRACKETS. DETECTOR WITH ONE STEP AUDIO. TUNES FROM 10 TO 110 METERS. DESIGNED AND BUILT EXPRESSLY FOR THE SHORT WAVES—NO DEAD-SPOTS—NO DEAD ENDS—NO LONG LEADS—NO BODY CAPACITY—ABSOLUTELY LOW LOSS THROUGHOUT. COMPLETE IN MAHOAGANY CABINET \$38.00. FULL LINE OF ACME, THORDARSON, JEWELL, WESTON, PYREX, ALLEN-BRADLEY, GENERAL RADIO, FARADON, RCA. ALL APPARATUS AT GREAT SAVING. NEW AERO SHORT WAVE COILS ON HAND. SEND STAMP FOR OUR LATEST BULLETIN AND PRICE LIST. IT PAYS TO DEAL WITH 'A. R. S. CO.'—WE'RE DEVOTED EXCLUSIVELY TO THE HAM. ALLOW POSTAGE WITH YOUR ORDER—WE SHIP C. O. D. IF YOU WISH. AMATEUR RADIO SPECIALTY CO., 77 CORTLAND STREET, NEW YORK CITY.

FOR SALE—ESCO 2000 Volt 1000 Watt 800-1200 Volt double commutator 110-220 Volt 60 cycle single phase ring oiled motor generator and field rheostat like new. First P. O. Money order for \$300.00 takes the works. H. G. Jamison, 147 Mayflower St., Pittsburgh, Pa.

ICHQ Press, 424 Park Road, West Hartford, Connecticut
—“Quality Cards for Hams.”

HELP! POLICE! Our Mailman QUIT from overwork. HERE'S WHAT CAUSED IT. Lo Loss Pancake inductances 20-40 meters \$4.95. 30 meters \$5.25. CARDWELL rebuilt DOUBLE SPACED CONDENSERS \$3.95 RADIO-LEAK transmitting GRID LEAK \$4.95. CUNNINGHAM CX 201A \$1.50. 50 Watt Sockets \$1.25. REL coils \$4.25. JEWELL METERS 20% OFF. SHORT WAVE RECEIVER 10 meters up \$38.00. R. E. L. Pyrex INDUCTANCES \$5.50 AS Described in QST with rods \$11.00. LOOK! KEYS from \$1.95 up. UX 210 7 1/2 Watter \$7.95 TUNED RADIO FREQUENCY KIT list \$16.50 SPECIAL \$3.95. General Radio Wall insulators 23 cents. General Radio 1 ohm 2 1/2 amp rheostat \$5.50. SAY OM we have everything you want if you just let us have your card we'll mail you list with prices—THAT'LL KNOCK YOU OFF YOUR FEET. COMON BOYS WE GOT A NEW MAILMAN. LETS SEE YOUR CARD. Hudson Radio Company 1416 Wythe Place, New York City.

Single variable condensers all sizes, 3 plate to 43 plate .78 each. Acme A-2 Audio transformers \$2.35 each. Send for our Bulletin. Raphael-James, Story City, Iowa.

GRIDLEAKS. Brand new General Electric 5,000 ohm and 10,000 ohm enamelled units. Order one and keep your plate from melting. Price \$1.25 for 5,000 ohm; 10,000 ohm for \$1.75. Utility Radio, 58 North Sixth Street, Newark, N. J.

750-WATT TRANSFORMERS 1500 each side. FOR DEFOREST H-TUBES \$15.00. CURTIS-GRIFFITH, FORT WORTH.

1000-volt, 400-watt, four-bearing, ring-oiled Escro motor-generator, 110-220, 60-cycle AC drive just completely overhauled by Escro and guaranteed perfect \$75 express collect. 2WC.

Motor Generator Bargains. Western Electric 110-220 V. Alternating Generator 1500 Volts 600 Watts \$135.00. Robbins & Myers 220 V. 60 cycle three phase; generator 750 V. 400 Watts \$60.00. Escro 110 V. Generator 350 V. 100 Watts \$30.00. Robbins & Myers 110 V. 60 cycle single phase; Generator 750 V. 400 W. \$70.00. Escro 220 V. 60 cycle 3 phase 1750; Generator 400 V. 100 W. \$25.00 110 V. A. C. 260 V. D. C. \$25.00 220 V. Direct Current Generator 1500 V. 500 W. \$75.00. All above machines are ring oiled. Also many others including several 3000 and 4000 V. machines. New 1/4 H.P. 220 V. 60 cycle 3450 Speed motors \$8.50, 110 V. \$9.50 1/2 H.P. 220 V. 3450 R.P.M. \$17.50 1/2 H.P. 110 V. 3450 R.P.M. \$18.50. Write us for prices on anything in motors, generators and motor generators, stating kind of current, voltage etc. QUEEN CITY ELECTRIC CO., 1734 GRAND AV., CHICAGO, ILL.

NEW Western Electric Power Amplifier complete with horn and tubes, \$55.00. Box 1450, Springfield, Mass.

Complete 50 watt short wave transmitter 20—190 meters. including W. E. 216A tube, 3 jewel meters, separate acme filament and plate transformer, mounted on 1/4" bakelite

base. Also Grebe CR-13 receiver, extra 1 step audio amplifier. Everything in A-1 condition. Complete if taken at once \$150.00. Rev. C. B. Liedgens, L'Anse, Michigan. 9BOM.

HAMS! 1CDM-2CMJ selling out. New 203-A \$25. Jewell Thermo-couple 0-8 and 0-2.5 \$5 each. Thordarson Power Transformers 1500 plate, 12 filament voltage, together \$15. Other bargains in transmitting apparatus. G. Battey, 1308 Yale Station, New Haven, Conn.

SACRIFICE—Grebe CR9 \$15.00 WE7a Amplifier three tubes \$20.00. Acme Filament Transformer 60c 300w \$7.50. All best condition. Platten Radio, Green Bay, Wisconsin.

EDGEWISE wound copper ribbon, the only really satisfactory antenna inductance .350" wide; 3/4" outside diameter 10c turn; 4 1/4" 13c turn; 5 1/4" 15c turn; 6 1/4" 17c turn; 7 1/4" 20c turn, prepaid any number turns in one piece; Geo. Schulz, Calumet, Michigan.

AMRAD S tube for sale-special-\$4.95. A large stock of generators on hand. Central Radio Company, 193 Center Street, New York City.

DOUBLE spaced transmitting variable condensers built to order with 3 1/2" Bakelite dials, hard rubber end plates, brass parts nickel plated, aluminum plates 17 plate \$3.50, 23 plates \$4.00 postage and insurance prepaid, 1/2 cash with order. Satisfaction or money back. Geo. Schulz, Calumet, Michigan.

THORDARSON 650-VOLT POWER-FILAMENT TRANSFORMERS for 5-WATERS \$6.90. CURTIS-GRIFFITH, FORT WORTH.

NEW GENERATORS, rated at 275 volts 120 watts will give 500 volts \$8. UC1831 variable 4000 volt condensers \$1.50. Bakelite 2 coil honeycomb, geared mountings \$1.50. Western Electric microphones \$1. VT2s \$4, VT1s \$3. Used generators, 30 volt direct current input, output 300 volts \$8. 500 cycle 200 watt \$10. 1/2 KW \$15. SEND STAMP for list. R. Wood, 38 Way Ave., Corona, New York.

SELL—NEW DEFOREST H TUBE \$12.00. PAUL KAROW, DEFOREST, WISCONSIN.

REAL BARGAINS:—New and perfect UP-1016, 750 watt Power Transformers, 3000v with midtap; Filament winding 10v with midtap, \$10.00; UP-1656, Filament Transformers 75 watt, 7.5v with midtap, \$4.00; UP-1658 Filament Transformers 150 watt, 10v with midtap, \$5.00; .0005 \$2.50; Signal R-48 Telegraph Keys \$2.25; Jewell UV-712 Audio Transformers 9/1, \$2.00; UC-1831 4000v Variable Transmitting Condensers, \$1.50; UC-1808 Antenna Coupling Condensers, \$1.50; Genuine Holtzer-Cabot No. 4 Headphones, 2200 ohms, double pole, high grade, \$3.00; Signal Cardwell Type 123-B Variable Condensers .0005 \$2.50; Signal R-48 Telegraph Keys \$2.25; Jewell Meters for immediate delivery, send for catalog. UC-490 Filter Condensers 1750v, 1mf, \$3.25; UC-1014 Grid Condensers, \$2.25; 1000v Mica Condensers, .001 mfd. Bakelite mounted, 25c. Bakelite Navy Key Knobs, 25c. Cutler-Hammer Variable Grid Leaks, 35c. AMRAD NO. 2796 Lightning Switches mounted on 5" porcelain posts, \$1.50. Day-Fan Balanced Vernier Condensers, 7 or 13 plates may be used, Bakelite ends, \$1.50—F-F Battery Chargers 6 amps, 110v AC 60 cyc. \$9.00. Send for discount sheet and keep in touch with bargains. 25% deposit on C. O. D. orders. All items under 4 Lbs. postpaid. STATE RADIO CO., 236 Columbia Road, Dorchester, Mass.

30-220 Two tube receiver \$12.00, omnigraph—\$10.00, 12-350 dynamotor \$12.00, 10-650 volt transformer \$6.00. Oliver Kirchner, Carthage, Illinois.

FOR SALE—genuine CX-310 tubes, \$6.85 each. 9DI, Tobias, Nebraska.

PURE ALUMINUM and lead rectifier elements, holes drilled with brass screws and nuts per pair 1/16" 1"x4", 13c. 1x6, 15c. 1 1/4"x6, 17c. 1 1/2"x6, 19c. single elements half price. Sheet aluminum 1/16" \$1.00, 1/8" \$1.90. Lead \$1.00 square foot all prepaid. Pure ammonium phosphate \$1.15 lb. prepaid to 5th zone. Enough for 12 pints. Geo. Schulz, Calumet, Michigan.

½ KW Packard Transformer for sale. Guaranteed perfect. Homemade case. Roland Porter, Newtown, Pennsylvania.

Eliminator parts. Audio transformers. Impedance amplifier units, for replacing transformers without changing wire. Change over that last stage and make a latest model. Write for list. M. Leitch, 32 South Park Drive, West Orange, N. J.

"ANNOUNCING THE SECOND EDITION OF THE HAM CATALOG WITH NEW LOWER LOSS PRICES THAT MEAN REAL SAVINGS. To reduce overhead expense to the fellows who really want equipment. The new catalog is 6c (actual cost). It will be the best 6c you ever invested, OM. Here are some samples: ROICE 5 WATERS \$2.85. THORDARSON 5 WATT SPECIAL PLATE AND FILAMENT TRANSFORMERS \$6.35. Roice new POWER AMPLIFYING TUBES change these DX Sigs from QRZ to QSA. Storage TYPE UX 112, \$2.50. DRY BAT TYPE UX-120, \$1.50. Isolantite Sockets for X and Standard type tubes now 55c. NATIONAL TYPE 150 TRANSMITTING CONDENSER \$5.25—WITH VELVET VERNIER DIAL \$6.90. Postage on equipment extra." THE HAM SHOP 5-01, RUSTON, LOUISIANA.

JUST TO KEEP RECORDS STRAIGHT
Must confess errors in March Ham Ad.
7IE read 7EL—8BTC read 8DTC—9APS read 9ASP—
9AIQ read 9AIU—9EJI read 9EIJ.
DODGE RADIO SHORTEKUT, Mamaroneck, N. Y.

TWO KILOWATT SPARK IS OBSOLETE. NOW CONVERTED TO ICW FOR MARINE WORK. DRAW THE NEW CIRCUIT FOR YOUR COMMERCIAL EXAM. COMPLETE BLUEPRINT AND DESCRIPTION ONE DOLLAR. COMMERCIAL RADIO TRAFFIC MANUAL—ONLY BOOK PUBLISHED COVERING THIS SUBJECT—ONE DOLLAR. BOTH \$1.50. Howard S. Pyle, 1922 Transportation Building, Chicago, Ill.

Grebe CR130 to 300 meters. First money order for \$65 takes it.
Whiting, 118 Wall Street, Bridgeport, Conn.

AMATEUR RADIO IS GOOD DURING SUMMER. DON'T BE DISCOURAGED. USE GOOD EQUIPMENT AND GET THERE. ENSALL RADIO LAB. EQUIPMENT IS GUARANTEED TO WORK. THE SHORT WAVE RECEIVER WITH RANGE FROM 5 TO 200 METERS WORKS SMOOTHLY OVER THE ENTIRE RANGE. ALL TRANSMITTERS ARE TESTED AND WORK. WE BUILD TO ORDER ANYTHING IN THE LINE OF RADIO. SPECIAL INDUCTANCES. WAVE METERS. TRANSMITTERS OF ANY POWER FOR ANY WAVELENGTH RANGE. ALSO RECEIVERS. WE SUPPLY BROADCAST EQUIPMENT AT A DISCOUNT. TRANSMITTING PARTS SUCH AS CARDWELL, GENERAL INDUSTRIES, CRESCENT RADIO, GENERAL RADIO, THORDARSON, ACME, JEWEL, WESTON AND MANY OTHERS. FOR ANYTHING IN RADIO DROP US A LINE. WE GUARANTEE ALL SUPER-HETERODYNE RECEIVERS BUILT HERE TO WORK. WE REPAIR AND BUILD TO ORDER THIS TYPE OF RECEIVER. MANY BROADCAST RECEIVERS AND PARTS AT A 50% DISCOUNT. IF IT'S AMATEUR RADIO LET'S HAVE THE DOPE. FOR ANYTHING IN RADIO DROP US A LINE. QUOTATIONS GLADLY GIVEN. GET QSO. THOS. ENSALL (ENSALL RADIO LAB.), 1208 GRANDVIEW AVE., WARREN, OHIO.
(Designers Of High Grade Amateur And Broadcast Radio Equipment).

WANTED used Omnigraph, give particulars and price. CHAS. LAPP, MT. OLIVER, P. O. CARRICK, PENNSYLVANIA.

QSL CARDS: 8BJT will be on the job during June. Send orders and inquiries for samples to R. J. Mumaw, Care E.M.S., Harrisonburg, Va.

SNYDER \$18.00 Loudspeaker \$14.40 to hams. 20% off to licensed amateurs on sets and parts. Radio Specialty Shop, 525 Park Avenue, Kent, Ohio.

TEN watt for sale. Write J. Ennis, Castleton, New York.

FOR SALE: High quality laboratory measuring instruments at half price. Send for list and quotations. HARDSOEG MFG. COMPANY, Ottumwa, Iowa.

SAY YOU SAW IT IN QST—IT IDENTIFIES YOU AND HELPS QST

2BIR SEZ: "The best fifty cents worth I ever got." Meaning of course the International Amateur Call Book.

FOR SALE: U. V. 204A. Excellent condition. A. H. Hardwick, Orange, New Jersey.

SELL 2000 volt DC MG, Good condition, \$125.00 Also two W.E. fifties \$20. Each or both for \$35.00. 9CP.

GRID AND PLATE CONDENSERS. Use RCA UC1015 mica condensers. The .001 mfd. connection is right for plate blocking. Try different capacities from .0002 mfd. up for grid and get a DC note on short waves. Stand 7,500 volts. Price \$1.25 postpaid. Utility Radio Company, 58 North Sixth Street, Newark, N. J.

SILICON Transformer Steel cut to order .014". 10 lbs. 25 cents, 5 lbs. 30 cents, less than 5 lbs. 35 cents per lb. 4 cubic inches to the lb. .007" for radio frequency transformers, 50c cubic inch, postage extra. At least ½ cash with order—balance C. O. D. Geo. Schulz, Calumet, Michigan.

MAGNAVOX LOUDSPEAKERS R2 \$20, R3 \$14. Want 1500 volt dynamotor. A. R. Ueleke, Jackson, Missouri.

RCA FIFTY WATERS—Two UV203 at \$10.00 each. Five UV203A at \$15.00 each. Slightly used. 8DAT, S. F. Northcott, 1204 N. Birney, Bay City, Michigan.

OMNIGRAPHS. ELIMINATORS, VIBROPLEXES, BOUGHT, SOLD. RYAN RADIO COMPANY, HANNIBAL, MISSOURI.

SOMETHING NEW—pure silver plated soft drawn No. 18 copper wire. Conductivity of silver is 100%. Great for low-loss coils, wiring up the set, etc. Only .75 per pound. Write for prices on other sizes. Radio 1AWW—T. F. Cushing, 78 College St., Springfield, Mass.

BETTER Edison Elements, welded connections, 7c pair. Sample cell 10c. Paul Mills, Woodburn, Oregon.

ATTENTION! NOSOTROS ESCRIBIMOS ESPANOL. THORDARSON POWER TRANSFORMERS 550 each side \$9.95. SPECIAL POWER-FILAMENT 250-WATT TRANSFORMERS 350-550 each side \$10.50. ALUMINUM square foot 85c. LEAD square foot 85c. JEWELL 0-15 AC VOLTMETERS \$7.50. "HAM-LIST" 4c. SERVICE—THAT'S US. CURTIS-GRIFFITH, 1109 Eighth Avenue, Fort Worth, Texas.

FOR SALE—Three-hundred cell Edison B Battery, with charging generator complete. Perfect condition. Heavy eypress case. \$35. D.C. 600 voltmeter \$5.00. Dynamotor \$5.00. Edison A elements 3c pair. 9DMI selling out. Sherman O. Myers, Nappanee, Indiana.

50 MOTOR GENERATORS ON SALE. 1000 volts 250 watts 3400 RPM wickoled with 110 volt 60 cycle motors. FOB Chicago, \$78.00. list price \$148.00. These sets are our latest model and designed to produce a smooth flowing DC easy to filter, with excellent results on long distance. Every set guaranteed—cash with order. Morton Electric Company, 4832 Rice Street, Chicago, Illinois.

SHORT WAVE couplers \$2.75. Prepaid cash with order. Martien Radio Shop, Galion, Ohio.

SELLING all equipment used less than two hundred hours—2 W.E. 50 watters, \$15.00 each. 2 RCA 50 watt sockets, \$1.00 each. 1 Thordarson 450 watt plate transformer, \$10.00. 1 Thordarson 150 watt filament transformer, \$5.00. 1 Radiostat, \$4.00. 1 5000 ohm 500 watt gridleak, \$2.00. 1 Jewell AC 0-15 voltmeter, \$5.00. 1 Jewell 0-300 milliammeter, \$5.00. 1 Weston 0-2 RF ammeter, \$8.00. Immediate shipment prepaid for cash. J. W. Hodgman, Coldwater, Mich.

No. 14 enameled \$4.75 per 1000 ft. No. 12, \$7. UM533 Hot-wire ammeters \$1. 1803 condensers .000025 mfd. 50c. 400 volt Federal 2mfd. \$1. 75 watt 1656 filament transformers \$3.75. 150 watt 1658, \$5.00. 750 watt 1016, \$11. 75 watt Acme \$6. Generators \$8. Postage extra. R. Wood, 38 Way Avenue, Corona, N. Y.

Elements! A's drilled, 4c pair. G's drilled, 3c pair. Rubber separators 5c dozen. Nickel wire 1c foot. Peppo solution \$1.00 for 100v. Prepaid. Wm. Woodore, 1417 Clairmount, Detroit, Michigan. 8DAC.

HEADQUARTERS FOR HAM STUFF: ASK FOR OUR CATALOGUE A-2. WE SPECIALIZE IN AMATEUR TRANSMITTING AND RECEIVING APPARATUS. NO. 12 "DYNEX" SOLID COPPER ENAMELED AERIAL WIRE, 1c FT. NO. 10 (FOR HEAVY DUTY), 1 1/4c FT. NO. 14, 3/4c FT. PYREX GLASS TRANSMITTING INSULATORS, 12", \$1.50; 7 1/4", \$1.50. RECEIVING SIZE 45c. PYREX LEAD-IN BOWLS, \$1.50. WE ALSO CARRY THE PYREX STAND-OFF INSULATORS, FLERON LEAD-IN INSULATORS, \$1.10. BARKELEW LIGHTNING SWITCHES, \$2.50. WARD-LEONARD 5000 OHM GRID LEAKS, \$2.00. ALLEN-BRADLEY RADIOSTAT, \$6.50. TYPE E-210, \$4.00. RADIOLEAK (VARIABLE TRANSMITTING GRID LEAK), \$5.00. ACME 2 MFD, 2000 VOLT CONDENSERS, \$6.50. 2 MFD 750 VOLT CONDENSERS, \$2.50. FEDERAL 1 MFD, 1000 VOLT, \$2.00. RCA, UC-490, 1 MFD, 1750 VOLTS, \$2.50. FEDERAL MICRAPHONES, DESK TYPE, \$6.50. HAND TYPE, \$7.00. NATIONAL AND CARDWELL TRANSMITTING CONDENSERS IN STOCK. ALL SIZES ACME CHOKES AND TRANSFORMERS. A FULL LINE OF JEWELL METERS. THORDARSON 30 WATT FILAMENT TRANSFORMER, \$7.00. 150 WATT, \$10.00. 300 WATT \$15.00. THORDARSON PLATE TRANSFORMERS, 100 WATT, \$18.00. 450 WATT, \$18.00. 900 WATT, \$30.00. LEAD AND ALUMINUM, 90c SQ. FT. "DYNEX" KEM ELEMENTS. 1" x 4", 6c EACH. 1" x 6", 7c. 1 1/2" x 6", 8c. BREMER-TULLEY PLUG-IN HAM TUNER, \$8.00. BRADLEYSTATS, \$1.85. GAROD-PYREX SOCKETS, \$1.50. PYREX SOCKETS FOR UX TUBES, 70c. NATIONAL, KARAS, GENERAL RADIO AND CARDWELL CONDENSERS FOR THAT SHORT WAVE TUNER. NATIONAL VELVET VERNIER DIALS, \$2.50. NO. 16 COTENAMEL, 75c LB. THE NEW CITIZENS RADIO CALL BOOK (HAM EDITION), 75c. "EVERYTHING FOR THE HAM" IS OUR MOTTO. "DYNEX FOR DX" OUR TRADEMARK. WE SHIP C.O.D. IF DESIRED. WE ARE THE "EIGHT THAT PAYS THE FREIGHT" EAST OF THE ROCKIES. NICHOLSON ELECTRIC CO., (OPERATING 8BIN), 1407 FIRST NORTH ST., SYRACUSE, N. Y.

BE AHEAD OF THE TIMES! WHAT'S NEXT? WIRELESS TRANSMISSION OF PHOTOGRAPHS! THE ESSENTIAL PART FOR TRANSMISSION OF PHOTOS IS THE PHOTOELECTRIC CELL. WE HAVE THE BEST THERE IS. THIS CELL WILL OPERATE WITH NO LAG AND WILL FIT INTO REGULAR NAVY BASE SOCKET. PRICE \$15.00. DIAGRAM FREE. SOME OF OUR OTHER SPECIALS: FEDERAL No. 61, 6-tube set, complete with headset, absolutely new and in original carton, list, \$223. Our price \$50.00. KENNEDY 3-Tube set, List, \$88.75. Our Price \$20.00. AMRAD 5-Tube NEUTRODYNE, List, \$85.00, Our Price, \$30.00. ATLAS GOOSENECK SPEAKER, List, \$30.00, Our Price, \$8.95. HOLTZER-CABOT PHONOGRAPH UNIT, Special type for each make of phonograph, List, \$10.00. OUR PRICE, \$3.45. GENUINE BROWNING-DRAKE EQUICYCLE KIT, \$18.75. SAMSON AUDIO TRANSFORMERS, \$3.85. COTOIL AUDIO TRANSFORMER, 95c. 7x18 MAHOAGNY CABINETS, \$2.00. DRY CELLS 3 for \$1.00. MURDOCK 4-WAY PLUG, List \$1.00, OUR PRICE, 75c. CARDWELL .0005 CONDENSER, List, \$5.00; OUR PRICE, \$1.50. RELIANCE HYDROMETERS, 49c. YANKEE VOLTMETERS, 65c. YANKEE VOLTAMMETERS, 85c. APO SILENT VIBRATING CHARGER, List, \$18.50; OUR PRICE, \$11.95. KENNEDY 3000-OHM HEADSET, Made by Western Electric, List, \$5.00, Our Price, \$1.75. COMPLETE ANTENNA KITS, \$1.60. PUDLIN FIXED GRID LEAKS 10c. AUTOSTATS, 10c. POLYMET 3-STAGE RESISTANCE COUPLED KIT, containing 1 Polymet Condenser Mounting, 3 Polymet Resisto-Couplers, 3 Polymet Fixed Condensers, .006MFD, 1 Polymet Fixed condenser, .002 MFD, 3 Polymet Resistors, 100,000 Ohms, 1 Polymet Grid Leak, 1 Megohm, 1 Polymet Grid Leak 1/2 Megohm, and 1 Polymet Grid Leak, 1/4 Megohm: OUR PRICE, \$3.80. E-Z AUTOMATIC PLUGS, 35c. E-Z PHONE CONNECTORS, 35c. ACME TRICKLE CHARGER, Complete with bulb, \$9.50. SIGNOLA LOOP, \$3.00. IF YOU DO NOT FIND WHAT YOU WANT HERE WRITE US! WE GUARANTEE EVERYTHING WE SELL. TERMS: 10% WITH ORDER. BALANCE C. O. D. BANK REFERENCE: LIBERTY TRUST COMPANY, BOSTON, MASS. RADIO SURPLUS CORPORATION, 11-19 STUART STREET, BOSTON, MASS.

WANTED—Frequency meter 250 cycles, also 1000 cycles. Charles C. Henry, Sonora Phonograph Company, 279 Broadway, New York City.

FREE! BLUEPRINT OF NOVEL TRANSMITTER! RADIO SURPLUS CORPORATION, 11-19 STUART STREET, BOSTON, MASS.

SAY YOU SAW IT IN QST—IT IDENTIFIES YOU AND

TOBE TRANSMITTING CONDENSERS 2 Mfd. 1000 volt \$2.65, 2000 volt \$7.50. Write us for information on high-grade HAM Equipment sold direct to you by mail. We send full information and literature. M. B. S. Sales Co. Dept. A, 27 School St., Boston, Mass.

WANTED—Small generator, 1000 cycles or greater. Charles C. Henry, Sonora Phonograph Company, 279 Broadway, New York City.

Q R A SECTION

50c straight, with copy in following form only: CALL—NAME—ADDRESS. Any other form takes regular HAM-AD rates.

1APD—Arthur E. Chase, 127 Huntington St., Hartford, Connecticut.

1BMG—Charles H. Stevens, 94 Prospect Street, Stafford Springs, Connecticut.

1CKM—C. D. Moir, Box 121, Shrewsbury, Mass.

1RD—J. Raymond Decker, 212 Winslow Road, Waban, Massachusetts.

1VA—J. Smith Dodge, 83 Willow Ave., Somerville, Mass.

1ZA—C. E. Jeffrey, Jr., 725 Commonwealth Ave., Newton Center, Massachusetts.

2ATM—John B. Trevor, Jr., 11 East 91 St., New York City.

2AVP—Ex 2AHI, Maurice Grayle Suffern, 607 West Beech Street, Long Beach, Long Island.

2CHX—Harold Sachs, 161 West 75th Street, New York City.

2LA—Robert Lawrence Fischer, 53 Glen Road, Larchmont Woods, New Rochelle, New York.

2MK—E. F. Reynolds, Central Valley, Orange County, New York.

2OU—John H. Baile, Jr., 422 Ocean Ave., Jersey City, N. J.

2PX—F. V. Broady, 35 Wagner Ave., Schenectady, New York.

3AIB—Bernard J. Mack, 1418 Hull Street, Baltimore, Maryland.

3AIJ—W. L. Snyder, Clarksville, Virginia.

3AIR—Fernand Causse, Box 81, Lester, Penn.

3AKD—Roger Causse, Box 81, Lester, Penn.

3AKQ—H. B. Doten, Virginia Beach, Virginia.

3KP—Roland W. Porter, Newtown, Penn.

3AME—Chester A. Baker, Morris County, Montville, N. J.

3PU—William D. MacLellan, 3536 Roland Ave., Baltimore, Maryland.

4FH—W. A. Wright, Coalfield, Tennessee.

4MW—H. Wall, 1407 Nance Ave., Tampa, Florida.

5AQF—Frank B. Beuhler, Box 373, Alexandria, Louisiana.

6BJI—Ex 7MU-70L, F. F. Taylor, c/o Lake Side Club, Roosevelt, Arizona.

8ALU—J. A. Carnes, M. D., 811 Plum St., Massillon, Ohio.

8CWR—F. Kelwin Kearney, 5053 South Martindale Ave., Detroit, Michigan.

8CWT—Quentin D. Bellas, 402 Armstrong Ave., Apollo, Pennsylvania.

8DOY—H. C. Morrison, 333 Rohrer Street, Greensburg, Pennsylvania.

8LA—C. O. Slyfield, Slyfield's Radio School, Frankfort, Michigan.

9ADZ—Henry M. Licht, 514 Powell St., Streator, Illinois.

9AGD—John W. Stillinger, 707 Fairview Ave., Albion, Nebraska.

9ASN—Lowell H. Harris, 610 So. Second St., Elkhart, Indiana.

9BGL—L. C. Campbell, Miller, South Dakota.

9DCG—Roland B. Cooper, 326 Nicholas St., Vincennes, Indiana.

9DR—O'Rourke & Diehl, 2415 South 50th St., Omaha, Nebraska.

RZ6QA (ex-7AA), A. A. Santos, Box 53, Maranhao, Brazil, S. A.

The following stations belong to members of the A.R. R.L. Headquarters gang. Mail for them should be addressed care A.R.R.L., Hartford, Conn.

- | | |
|---------------------|------------------------|
| 1BAO R. S. Kruse | 1KP F. Cheyney Beekley |
| 1BDI F. E. Handy | 1OA R. S. Kruse |
| 1BHW K. B. Warner | 1SZ C. C. Rodimon |
| 1DQ John M. Clayton | 1XAQ R. S. Kruse |
| 1ES A. A. Hebert | |

BECOME A RADIO EXPERT

Our unique home-study course in practical radio engineering makes you an expert quickly. You devote spare-time hours to fascinating study of world's greatest science. We show you how to earn as you learn. To get into this big-pay field on the ground floor. Full equipment furnished free, including: Superheterodyne radio set. Our training is superior for you learn to make money from the start. **LEARN HOW TO GET PAID SOONER!**

Our unusual plan shows you how to get the course free. Write for details. Whether you know radio now or not, we will teach you (Gift). If you can read the book you can read our text. Numerous illustrated lessons and get a diploma as a radio engineer. Thousands of positions with good money open to you. Write to the field that will make you rich. If you make good, we'll give you \$1000.00. It is free. Write me today and learn how to make \$100 to \$200 a week. 2-2-35

AMERICAN RADIO ENGINEERS, Dept. 213, Hearst Sq., Chicago, U.S.A.

A&B Battery Charger ONLY \$2

Charges any type of storage A or B battery, or auto battery, using a few cents worth of ordinary house current. Cannot injure battery and lasts for years. Complete directions enclosed—anyone can operate. No "Extras" to buy. Satisfaction Guaranteed

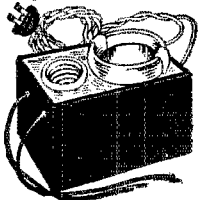

Why pay \$10.00 to \$18.00 for a charger when you can get this splendid GUARANTEED R. B. Charger by mailing us two dollars (bills, money order, check or stamps). Charger will be sent postpaid. If not satisfied, return in 5 days and we will refund your money. Act at once. TODAY.

R. B. SPECIALTY COMPANY

Dept. 809, 308 East Third, Cincinnati, Ohio

SAY YOU SAW IT IN QST—IT IDENTIFIES YOU AND HELPS QST

AEROVOX

By-Pass and Filter Condensers
"Built Better"

AEROVOX WIRELESS CORPORATION
489-491-493 Broome Street,
New York City

Branch Offices:
Chicago, Ill. Cincinnati, Ohio
58 W. Jackson Blvd. 304 Pal. Theatre Bldg.
Boston, Mass. Los Angeles, Cal.
104 Portland St. 324 N. San Pedro St.

THREE "E" STRAIGHT LINE RHEOSTAT

Perfect Control of Filament Temperature
Gives you a fine, smooth, dependable variation of filament temperature. Turns smoothly, is absolutely NOISELESS, and once set, "stays put!" Controls volume smoothly, and without distortion, over the entire range. Equally efficient for short and long wave sets. Its all means secure this precision instrument at once. Ask your dealer or order direct. Price \$2.50. Postpaid.

Illus. 1/2 Size 6-15-30 Ohms

ELECTRICAL ENGINEERS EQUIPMENT CO.
Radio Division
708 W. Madison St., Dept. 7 Chicago, Ill.
Information on Request

HERCULES AERIAL MAST

We pay freight

20 Ft. \$10. 40 Ft. \$25. 60 Ft. \$45.
All Steel Construction
Complete with guy-wires etc.

MAIL NOW FOR FULL DETAILS

S.W. HULL CO. Dept. D 2045 East 19th St. Cleveland, Ohio
Please send free the full details about the "HERCULES" Aerial Mast.

NAME _____ STREET _____ CITY _____

\$\$\$ \$

Prize contest

\$25
for five
words

First Prize:
Magnavox R₃ or
M₃ Loud Speak-
er; value \$25.00.

Second Prize:
Set of 5 Magna-
vox Tubes; value
\$12.50.

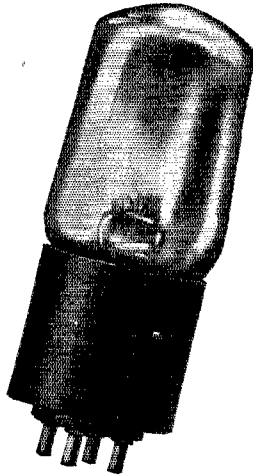

WE want a slogan to sum up the superiorities of the new Magnavox non-microphonic tubes. Perhaps you have used these tubes and have found some unusual feature. If so, put it in words and you may win a prize. If you don't know the Magnavox Tube, borrow one from a friend, read the following, ask the Magnavox dealer or write to us for full information.

The Magnavox Tube is ideal for short wave reception as its internal capacity is only 4.5 MMF. It oscillates freely on low wave lengths without unbiasing. Its amplification constant is very high, with low impedance. It is equally dependable for detecting or amplifying. It is backed by 15 years of radio manufacturing experience.

Rules of Contest:

1. Slogan must be non-technical —easy for laymen to grasp.
2. Must not be more than three to five words.
3. Contest closes June 15th. Announcement of winners will be made in QST, August issue.
4. The Magnavox Company will be sole judges.

Start right now to win one of these prizes. Address entries "Magnavox Contest."

THE MAGNAVOX COMPANY
OAKLAND, CALIFORNIA

24D10 In the Radio Business Since 1911 ©1926

\$\$\$ \$

SAY YOU SAW IT IN QST—IT IDENTIFIES YOU AND HELPS QST

—FOR YOUR CONVENIENCE—

QST'S INDEX OF ADVERTISERS IN THIS ISSUE

Aene Apparatus Co.	77
Advance Electric Co.	66
Aero Products Co.	87
Aerovox Wireless Corp.	93
All American Radio Corp.	84
American Radio Engineers	63, 68, 74, 78, 80
American Sales Co.	70
American Transformer Co.	70
A.R.R.L. Apparatus	80
A.R.R.L. Application Blank	76
A.R.R.L. Emblems	84
Benjamin Electric Mfg. Co.	66
Bremer Tully Mfg. Co.	74
Burgees Battery Co.	4th Cover
Burton-Rogers Co.	83
Cardwell Corp., Allen D.	75
Carter Radio Co.	82
Central Radio Laboratories	73
Coring Glass Works	80
Crescent Radio Supply Co.	78
Crosley Radio Corp.	82
Crouse, Carl	70
E. T. Cunningham, Inc.	2nd Cover
Davis, Inc., Richard T.	83
Deutschmann Co., Tohe	68
Dongan Elec. Mfg. Co.	74
Dubilier Cond. & Radio Corp.	65
Eagle Radio Co.	68
Eastern Radio Institute	78
East Side Y.M.C.A.	73
Electrical Eng. Equip. Co.	83
Electric Specialty Co.	85
Freed-Eisemann Radio Corp.	73
French Battery Co.	67
Frost, Herbert H.	68
General Instrument Co.	2
General Radio Co.	96
Grebe & Co., A. H.	1
Gross & Co., J.	86
Hilliard & Co., W. P.	68
Hughes Elec. Co., Benjamin	78
Hudson Division Convention	3d Cover
Hull & Co., S. W.	93
Jacobs, Charles F.	76
Jewell Elect. Inst. Co.	78
Karas Electric Co.	1
M. B. S. Sales Co.	84
Magnavox Co.	94
Mario Electric Co.	87
Martindale & Co., Thos.	86
National Carbon Co.	95
National Condenser	62
R. B. Specialty Co.	93
Radio Assoc. of Western N. Y.	61
Radio Elec. Works	84
Radio Engineering Labs.	63, 76, 83
Radio Surplus Corp.	79
Rush Au Co Supply Co.	79
Rooney, John T.	78
S-C Merchandising Co.	63
Sangamo Elec. Co.	72
Scientific Radio Service	80
Silver Marshall, Inc.	78
Stromberg-Carlson Telephone Mfg. Co.	71
Supreme Supplies Co.	86
Toaz Eng. & Sales Co.	74
Thordarson Electric Mfg. Co.	69
Utility Radio Co.	63
Vibroplex Co., Inc.	64
Weston Electrical Inst. Corp.	82
Wireless Specialty App. Co.	86
Wizard Wire Winder Co.	72
X-L Radio Labs.	72
Faxley Mfg. Co.	81

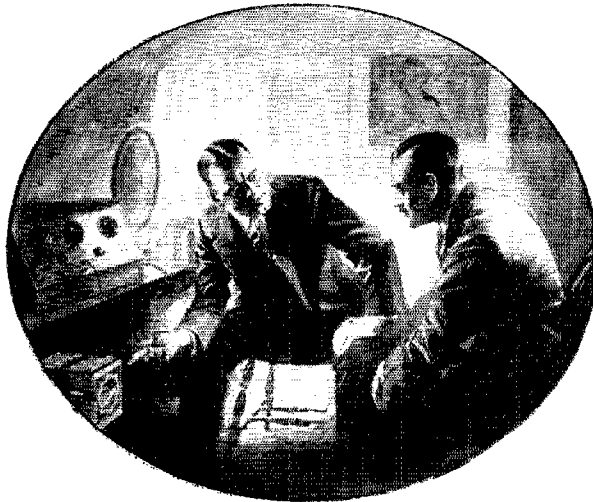

“The little wrinkle that makes my ‘B’ batteries last longer is using the right size Evereadys with a ‘C’ battery”

“I USED to think that because the Eveready ‘B’ Battery No. 772 cost less than either of the larger Heavy Duty Evereadys that I was saving money. As a matter of fact, on four or five tube sets, that was false economy.

“The right size Eveready ‘B’ Batteries to use depends on the number of tubes in your set. The life of the batteries depends on how much you listen in and on whether a ‘C’ battery is employed.”

To get the maximum of “B” battery life and satisfaction, follow these simple rules:

On 1 to 3 tubes—Use Eveready No. 772.

On 4 or more tubes—Use the Heavy Duty “B” Batteries, either No. 770, or the even longer-lived Eveready Layerbilt No. 486.

NOTE: A “C” battery greatly increases the life of your “B” batteries and gives a quality of reception unobtainable without it. Radio sets may easily be changed to permit the use of a “C” battery by any competent radio service man.

On all but single tube sets—Use a “C” battery.*

Follow these rules, and No. 772, on 1 to 3 tube sets, will last a year or more; Heavy Duties, on sets of 4 or more tubes, eight months or longer.

The average year-round use of a set is two hours a day. If you listen longer, your “B” batteries will have a somewhat shorter life. If you listen less, they will last longer.

Our new booklet, “Choosing and Using the Right Radio Batteries,” is free for the asking. It also tells about the proper battery equipment for the new power tubes.

Manufactured and guaranteed by
NATIONAL CARBON CO., INC.
New York San Francisco
Canadian National Carbon Co.,
Limited, Toronto, Ontario



LEFT—No. 486,
for 4, 5 or more
tubes. \$5.50.



RIGHT—Eveready Dry Cell Radio “A” Battery, 1½ volts.

EVEREADY

Radio Batteries

—they last longer—

Tuesday night means Eveready Hour—9 P. M., Eastern Standard Time, through the following stations:

WEAF—New York	WHA1—Cincinnati
WJAR—Providence	WEAR—Cleveland
WEEI—Boston	WWJ—Detroit
WTAG—Worcester	WGN—Chicago
WFI—Philadelphia	WOC—Davenport
WGR—Buffalo	WCCO—Minneapolis
WOAR—Pittsburgh	WCCO—St. Paul
	KSD—St. Louis

For Experimenters who prefer Impedance Coupled Amplification

*Type 369
Coupling
Impedance*

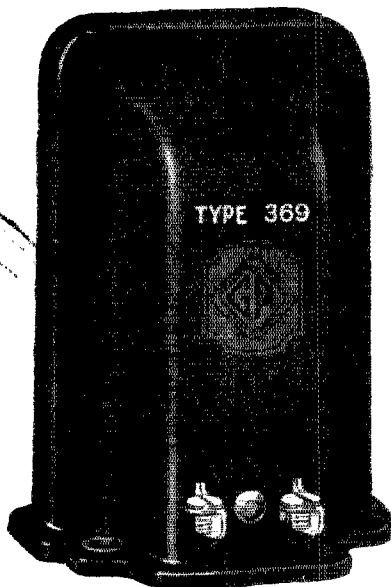

*Price
\$5.00*



The General Radio Company has endeavored to make it possible for the experimenter to obtain its products with a minimum of effort. A careful selection of distributors and dealers has been made. They are best fitted to serve you. If, however, you are unable to obtain our products in your particular locality they will be delivered to you, postpaid, direct from the factory upon receipt of list price.

In search for a perfect amplifier experimenters are now giving much attention to coupling impedances.

While transformer coupled amplification produces more amplification per stage than any other method under some conditions slightly better quality may be obtained by the use of impedances and resistances.

By using chokes of sufficiently high inductance, a quality of reproduction may be obtained equivalent to that produced by resistances.

The use of chokes has the added advantage of requiring considerable less plate voltage thus reducing operating costs of the set, and also giving greater amplification per stage.

A three stage amplifier using three General Radio Type 369 coupling impedances will give a combination of generous volume with exceptional purity of tone.

Write for our circular showing wiring diagram for a 3 Stage Impedance Coupled Amplifier and our latest parts catalog 924.

GENERAL RADIO

INSTRUMENTS

Behind the Panels of Better Built Sets

HUDSON DIVISION A. R. R. L. CONVENTION

A non-commercial meeting of A. R. R. L. Members

May 13th, 14th and 15th, 1926



United Engineering Societies Building
29 West 39th Street, New York



REGISTER AT ONCE!

HONORARY COMMITTEE OF SPONSORS

Chairman, Hiram Percy Maxim
President American Radio Re-
lay League

Senatore Guglielmo Marconi

Honorable Curtis D. Wilbur
Secretary of the Navy

Honorable Herbert Hoover
Secretary of Commerce

Donald McNicol
President Institute of Radio En-
gineers

Captain Ridley McLean, U.S.N.
Director of Naval Communica-
tions

Maj.-Gen. C. McK. Saltzman
U. S. A.
Chief Signal Officer, U. S. Army

Captain Tom C. Rives, U. S. A.
Liaison Officer, Army-Amateur
Net

Colonel Edward T. Hartmann,
U. S. A.
2d Corps Area Signal Officer

Captain John Autrey, U. S. A.
Assistant 2d Corps Area Signal
Officer

A Registration Fee of \$1.00 admits to all Convention activities.

Finest and most complete exhibit of amateur transmitting and receiving apparatus ever held.

The feature of the Convention is the Educational Courses:

The "A" Course for Licensed Amateurs—A complete resume of modern amateur theory and practice.

The "B" Course for Beginners—The elementary requirements for the beginner wishing to enter the amateur transmitting field.

Each course consists of nine hours of lectures and demonstrations in three sessions commencing at 8 p. m. on Thursday May 13th and Friday May 14th and at 3 p. m. Saturday May 15th. Courses will be limited in number; therefore register at once, specifying which course.

Registration open to League members only. If you are not a member of the League, fill out the blank on page 76 of this *QST* and send it along with \$2.50 to cover dues and *QST* subscription.

Convention Banquet at 8 p. m. Saturday May 15th, at Hotel Majestic, 72d Street at Central Park West. \$4.00 a plate.

\$5.00 covers entire convention activities including banquet.

Send all applications and registration fees to

DAVID TALLEY, Convention Treasurer
2222 Avenue O
Brooklyn, N. Y.

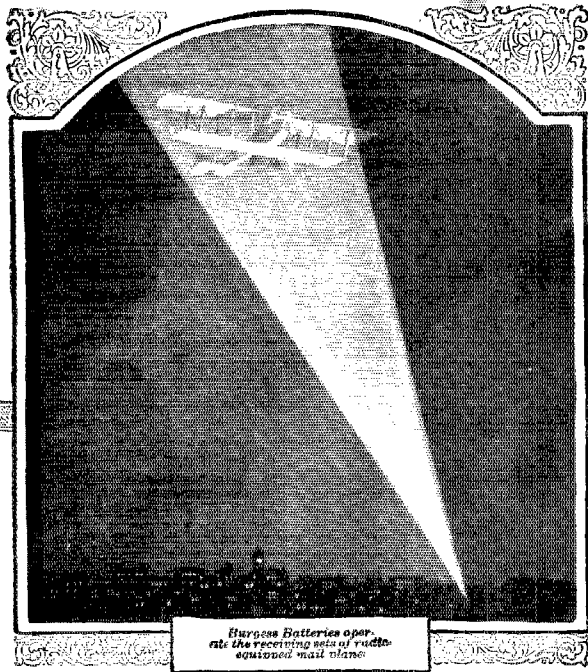

Burgess Batteries operate the receiving sets of radio-equipped mail planes.

An every-night adventure of Burgess Radio Batteries

ONE of the reasons why you should always buy Burgess Radio Batteries is that the batteries used by air-mail pilots—battleships—explorers and the majority of recognized radio engineers—are evolved in the Burgess Laboratories and manufactured in the Burgess factory.

These batteries are identical with the batteries sold by your dealer and thousands of other good dealers everywhere.

Ask Any Radio Engineer

BURGESS BATTERY COMPANY

GENERAL SALES OFFICE: CHICAGO

Canadian Factories and Offices: Niagara Falls and Winnipeg

BURGESS RADIO BATTERIES

The Communications Department

F. E. Handy, Communications Manager
1711 Park St., Hartford, Conn.

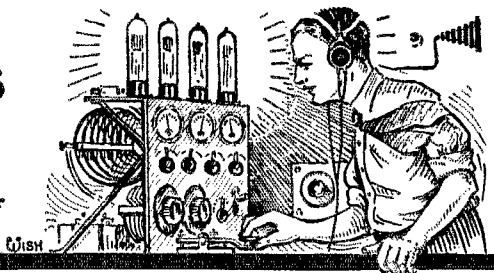

Australian Two-Way Reliability Tests

HOW many stations have we that can work Australia reliably? Who can work Australia anyway? Is 20 or 40 meters best? When? Can it be done on 5 meters?

We ask your heartiest cooperation in finding out the answers to those questions. If you think you can qualify, by all means write Headquarters for the test messages that will be given out to send to the Aussies.

The purpose of these tests is (1) to demonstrate to the world at large the advanced stage of amateur communication; (2) to provide further observations on the relative effectiveness of the 20 and 40 meter bands for Transpacific work; (3) to show the amount of work still undone; (4) to discover the most reliable and effective amateur station in each of the Australian and American states; (5) to establish definitely the hours during which reliable communication can be maintained across the Pacific; (6) to stimulate interest in short wave observations on 5, 10, 20, and 40 meters; and (7) to fill the air with signals of all shapes and forms to show that if no one else is alive the amateurs ARE!

The TESTS! The Wireless Institute of Australia have made all the necessary arrangements and announcements. Plenty of stations will be on the air with test messages of some length to transmit. The copies of Australian messages will be at Hartford where the messages you copy must be sent for verification. Each A.R.R.L. station owner who believes he can qualify will be provided with a similar test message of a few hundred of words. Copies of this test message will be on file at A.R.R.L. Headquarters as well as at the offices of the Wireless Institute of Australia. Transmitting stations participating in the tests will connect with Australian stations in the early days of each test and arrange schedules for the remaining periods during which as much of the text of the message will be put over as possible. The idea is, "Will you stand by and copy my message if I help you over with yours?"

As many stations as possible should be on the air for the whole 24 hours. Preferably half the stations should be on 20 and half on 40 meters so that a comparison of the work done on each band can be readily made. 20 meters has proved useful over these distances many times and we want to see a lot doing there this spring and summer. Perhaps the use of 20 meters at your station will mean that you win one of the certificates that will be given out after the dope on the tests has been analyzed. We urge that as far as possible stations in each state take shifts of several hours each so that there will be a good distribution of stations throughout the whole 24 hours. This matter will be taken up through Division Managers and Assistant Division Managers as the applications come in from those who are interested in making a name for themselves in these tests.

You will try to pass the test messages direct to an Australian station in the specified period. The accuracy with which the message is handled as well as the time taken will be considered in the comparison that will be made. Australian stations are all set for the tests and the test traffic.

Certificates will be issued all stations who get their long message over with at least 75% accuracy. If you sent a message over, you will get the "A" Class Transmitting Station certificate. If you worked an Aussie and copied a long message correctly, you will get the "A" Class Receiving Station certificate. If you are so fortunate as to have done both you will get "A" Class Transmitting and Receiving Station certificate. A report on the most reliable stations will appear in QST when the list is made up after the tests.

Pin this up in the shack.

DATES	TIME	PURPOSE
May 23—June 6	Starts 3 a.m. EST* (23rd) Finishes 3 a.m. EST* (6th)	500 - word-message handling competition for reliability determination. (two-week period)
May 29—30	Starts 3 a.m. EST* (29th) Finishes 3 a.m. EST* (30th)	24-hour 20 and 40 meter contact test—logs should be submitted to prove when 20 and 40 meter signals drop off and come to peak signal strength—special effort to get as many of messages through as possible in this period.
June 5—6	Starts 3 a.m. EST* (5th) Finishes 3 a.m. EST* (6th)	Australians will call "test" on 10 meters (30,000 kc) listening intermittently for replies on 20 meters. General two-way attempt to put over signals on 5 meters (60,000 kc).
May 26	Starts 3 a.m. EST* (26th) Finishes 7 a.m. EST* (26th)	
June 2	Starts 3 a.m. EST* (2nd) Finishes 3 a.m. EST* (2nd)	
May 27	Starts 3 a.m. EST* (27th) Finishes 7 a.m. EST* (27th)	
June 3	Starts 3 a.m. EST* (3rd) Finishes 3 a.m. EST* (3rd)	

What to do to get in on the fun!

1. If you think you can work Australia during the two-week period of the tests, drop a postal to ARRL HQ asking for a test message assignment.

2. Copy the schedules of the different tests and post them in the station.

3. Note carefully during which hours Australian signals are loudest and when the signals drop out altogether. If you hear or work Aussies between the dates of May 23 and June 6 note the time, date, wavelength, and signal quality and strength carefully. Report it to Headquarters to add to the mass of information and to get the credit due you for your work. The information on just what you heard will help us to check with Australian logs, so the more complete it is, the better.

4. Report any FIVE or TEN meter reception at once so we can check it. Also give Headquarters a log of your own 5 meter transmissions so we can supply a check should someone report your signals. Only reports that can be verified will count for anything in the tests. Something valuable will go to the experimenter who makes the first contact on these waves.

5. Report whatever work you do in the tests directly to Hartford so the information will be available for QST at an early date following the tests.

—F. E. H.

Army-Amateur Notes

FIRST CORPS Area—The amateurs here have shown a healthy interest in the Army Amateur Radio Station idea. About 100 stations, well distributed over the Corps Area have been issued certificates. All these stations transmit in either the forty or 80 meter band—many use both.

Skeleton nets cover all National Guard and Organized Reserve units. The headquarters of National Guard state and Organized Reserve Divisional nets are included in the Corps Area net with headquarters at Boston. These skeleton organizations are filling up rapidly.

An Ediphone Code Transmitter installed in Commonwealth Armory, Boston Headquarters, 26th Division, Mass. National Guard broadcasts code instruction on 80 meters every evening. Arrangements are being made to correct and grade all papers sent in by amateurs. Certificates are issued to all who qualify as radio operators. It is intended to expand this instruction soon enrolling amateurs in a correspondence course covering Army Radio Procedure and Army Radio Sets. While this instruction is primarily for amateurs within the Corps Area, students from other localities will be taken care of by these headquarters until similar instruction is given in their own Corps Area.

The following stations have been issued certificates to date: 1aab 1aae 1aal 1aav 1ac 1aci 1ack 1adi 1adl 1adw 1aed 1af 1afd 1aid 1aiv 1ajg 1alp 1ams 1amz 1aqa 1aps 1apu 1aql 1aqm 1arj 1ars 1asi 1asr 1asu 1atj 1atv 1auc 1avx 1aww 1axa 1axz 1ayj 1ayl 1bbj 1bbn 1bfq 1bft 1bvh 1bhh 1big 1bjk 1bjz 1bml 1brf 1bsg 1bsn 1bum 1bvz 1brv 1bvs 1caa 1cak 1caw 1cea 1cek 1cgd 1ch "chb" 1cln 1cax 1db 1dc 1dq 1eb 1ff 1hj 1il 1jl 1kp 1ky 1kz 1lp 1ny 1oc 1ok 1om 1py 1qm 1ok 1qy 1ru 1sk 1sl 1ul 1uj 1uu 1vf 1we 1wl 1wz 1xax 1yb 1yc 1zd 1zw.

Second Corps Area—Work on the Army Amateur plan is progressing satisfactorily. The Corps net station 2sc is working regularly on 77 meters. Army Amateur Net Control stations 2CXL and 2SC are making arrangements to exchange encoded or enciphered messages each Saturday night. Information regarding the methods used in deciphering or decoding these messages will be furnished all amateurs who notify the 2nd Corps Area, Signal Officer that they want it.

The following stations have received Army-Amateur certificates: 3xan 3zl 2zb 2adt 2at 2dx 2ka 2aho 2pe 2aza 2erp 2il 3ql 2awf 2pv 3hr 3atr 3bpm 3au 3kw 3dsi 2ks 3agd 2aoc 2nr 2evf.

Third Corps Area—No certificates have yet been issued in this Corps Area. Mr. Charles A. Miller, has been appointed ARRL contact representative and is selecting the most capable stations for appointment. Third Corps Area Radio station 3sn at Fort Howard, Md., works nightly on 8945 kc (76 m).

Fourth Corps Area—The work here is well under way. The present outlook is promising. Florida National Guard has made some progress in establishing the Governor's net. Mr. J. Morris, ARRL representative in this Corps Area has been ill with Grippe for the past six weeks. Three Organized Reserve Divisions have submitted a list of 69 amateur stations for appointment.

Certificates have been issued the following stations: 4io 4vf 4wj 4fx 5asu 4rf 4rr 4aa 5awf 4ib 5uk 5ac 4am 4aqf 5ajp.

Fifth Corps Area—8GZ is the control station for the Fifth Corps Area Net. A list of the common "Z" signals with their "Q" equivalents has been sent all amateurs who have written Corps Area Headquarters. 8GZ and 8BYN conducted a test broadcasting parts of instruction bulletin No. 1 to all interested amateurs who were instructed to send logs to Corps Area Headquarters to get a check on speed and accuracy. Appointment certificates are being sent as rapidly as amateurs are designated to certain units.

Sixth Corps Area—The Corps Net is complete with the exception of a station at Springfield, Ill. 9AWW is Net Control Station at Chicago. Mr. W. W. Birmingham, 9AFF, 2424 W. Monroe St., is his alternate carrying on as ARRL representative while Schweitzer is abroad. 8BMW is the net station at Detroit. 8ADW is alternate. 9DTK at Milwaukee has 3 alternates, 9VD, 9ATO and 9CQE. 9CCE handles this work at Madison, Wis. 9DOX, 9CBJ and 9BRM are in the Organized Reserve Net. A photostated map of the Corps Area and a list of appointed stations is sent out with the appointment certificate. March 25th a test message was sent all Corps Area Net Stations through 9AFF.

Seventh Corps Area—Mr. P. H. Quinby is ARRL representative for the Seventh Corps Area. National Guard nets are functioning in Kansas and Minnesota. Nebraska is being lined up and will begin operation in April. Certificates have been issued 9dpu 9bxx 9eel 9ego 9efg 9bnf 9egg 9dkr 9bxx 9cof 9coa 9af 9djjw 9btz 9bay and 9elc. Twenty-nine other stations are slated for appointment in the Organized Reserve Net.

Eighth Corps Area—The work is rapidly taking shape here. Amateurs are responding daily to the requests sent out and it is expected that all nets will be filled at any early date. The Governor's Radio Net has been organized and is in actual operation.

The following stations have been given Army Amateur Station Certificates: 6gk 5ajh 5lm 5ap 5zh 5ti 5amm 5aac 5ft 5zu 5zai 5zam 5abp 5io 5aq 5aab 5eo 5hy 5ael 5aji 5akn 5ajh 5se 5aim 5amb 5lf 5aky 5aec 5de 5av 5ot 5aei 5atz 5dr 5ahm 5gn 5dw 5al 5aq 5rz 5kv 5adi 5apw 5ox 5apv 5if 5oc 5adz 5qx 5ain 5ac 5hc 5he 5hs 5mm 5ux 5auy 5ph 5akl 5akz 5sd 5ajt 5lv.

Ninth Corps Area—Since the election of Mr. A. H. Babcock as ARRL contact representative, much work has been done in selecting Army Amateur Radio Stations. McGown's station, 6RI, was the first station appointed. This station is the principal radio station for the Headquarters Ninth Corps Area.

TRAFFIC BRIEFS

The Chicago Daily News—C.R.T.A. traffic service takes the prize position this month! The messages are mostly bona-fide business or personal and not broadcast listener applause traffic as mentioned last month. There follows a partial list of schedules of Chicago stations effectively handling the traffic:

Chicago Station	Days Times (CST)	Wave	Cities
9GE	Sun 2p	40	Milwaukee
9AAE	Daily 11p	174	Wilmere, Ky.
9APY	T, Th 7p	80	Indianapolis
9IX	Daily 11.30p	40	Brooklyn
9IX	Daily 11p	40	Jersey City
9IX	Daily 7p	40	Milwaukee
9IX	Daily 11p	40	Des Moines, Iowa
9IX	Daily 10a	40	E. Moline, Ill.
9QD	M, W, Sat 9.30p	88	Omaha, Neb.
9QD	Sun 6am	83	Burlington, Wis.
9QD	Daily 6pm	40	E. Moline
9CEJ	Daily 7.30p	40	San Diego, Cal.
9CEJ	Daily 2.35a	40	Bibourne, N. Z.
9WV	W, F, Sun 11.30p	80	St. Louis, Mo.
9ALG	W, Sat 9p	40	San Angelo, Tex.
9NV	Sun 9.30a	40	Sheboygan, Wis.
9NV	M, W, Fri 12.30p	40	Columbus, O.
9NV	T, Th 7p	40	State College, Pa. (8KE)

We are sorry that a list of the stations on the other end of these schedules is not available. We would like to see every large affiliated organization taking such a forward-looking step as this. 'Tis 'vy FB!! Several messages reached the coasts the same day they were filed. More reports on delivery are expected to show an improvement as the traffic committee work what troubles appear out of the present system, make more schedules and benefit from experience.

9DWH helped the Chicago Milwaukee and St. Paul R. R. during a recent snowstorm. When communication was cut off between Chicago and Kansas City he worked KC direct and got valuable information for the Chicago office. We have no report from the Kansas City end of the contact. Why not let us have details promptly when you do valuable work like this, gang?

Take a listen on 52.51 meters every Wednesday night. That is when the Canadian coast-to-coast "prayer meeting" is held. The weekly get-togethers do a lot to keep everybody acquainted and happy. Most U. S. amateurs have their local fun on 80 meters on Sunday afternoons. If you don't believe it just take a twirl over the eighty meter band. Get your transmitter going there, too. After getting QSO a dozen foreign countries, it seems good to chat with the fellow across the city and to run over and see his station.

By the way, the Canadian fellows have had their exclusive band extended to a width of ten kilocycles. (52.51-52.63 meters) 5700-5710 kcs).

Until June 15th Lee (4XE) will receive applications for 2 weeks training duty at Naval Radio Stations at St. Augustine, Jupiter, and Key West. This is authorized with full pay, full travel expense, and a dollar a day subsistence allowance. A wonderful opportunity for the gang, say we.

9CVC of Des Moines, Iowa is lining up stations from New York to San Francisco to establish a regular Trans Continental Relay Route. The Capitol City Radio Club are back of the work. Many fellows from coast to coast already belong to the Trans-Continental Relay Route Association. Everyone is boosting this move. Watch these pages for the accomplishments of the Association!

Club Activities

COLORADO—Stedman of 9CAA recently opened a series of discussions on radio amateurs for KOA, the Denver broadcasting station of the General Electric Chain.

ILLINOIS—The Chicago Radio Traffic Association has elected new officers. Mr. F. J. Hinds, 9APY, is now President. Mr. L. F. Pfeiler, 9EHS (9NV), a strong A.R.R.L. man attending Armour Institute, was elected Vice President. Mr. R. T. Prazak was re-elected as Secretary. Mr. H. Marquis, 9IX, was re-elected as Treasurer. 9AAN remains Sargeant at Arms and Housley remains Publicity Manager.

The free message service arranged in cooperation with the Chicago Daily News has proved the greatest traffic stunt in the history of the Association. The progress made on an elaborate system of schedules is recorded in *Traffic Briefs* this month. The Chicago Daily News has a circulation of over four hundred thousand and the messages collected through its channels are of real content and very "live" traffic. 9IX is chairman of the traffic committee. Message SERVICE is guaranteed with the scheduled cities.

INDIANA—The Indianapolis Radio Club held regular meetings in March at the Chamber of Commerce Building. Members were instrumental in locating interference for the Broadcast Listeners' Ass'n, thus bringing about cordial feelings on the part of both clubs. Naval Reserve officials have given the I.R.C. permanent quarters in the Naval Reserve building rent free. The fellows have fitted the place up in fine shape and now have one of the best amateur club rooms in the middle west.

The "Radio Club of Tri-State College" has just organized. The club is made up of amateurs, ex-commercial operators, and broadcast listeners, all students at the college. Code practise and radio theory classes are conducted for all the members and hold interest in good shape. A relay station is under construction at one of the college buildings and everyone looks forward to the time when it will get on the air to talk with other stations.

IOWA—The Capitol City Radio Club has started a message drive. Special message blanks have been distributed to all the local hotels.

MAINE—The Queen City Radio Club are holding regular meetings and growing fast. At a recent meeting at the University of Maine a "QST Advertising Contest" was held. Scores of clippings from different QST advertisements were flashed on a screen without the names of the advertisers. The object of the contest was to guess the names of the manufacturers represented. Advertisers would be surprised and pleased to learn the number of correct answers that were given. The winner had 80% of the answers right. The gang represented in the guessing "steer" a great deal of the buying for Bangor and vicinity. We will let the advertisers draw their own conclusions!!!

Results of the championship cracker eating contest will be available next month. The champion of the Poutney Vermont convention last fall has challenged the members of the Q.C.R.C. and they have taken him on. Watch this column for the next report!

MANITOBA—The regular meeting of the Winnipeg Radio Traffic Association was held March 30. An increased attendance showed the growth of the Association. March 16, at the previous meeting, c4CO gave an interesting paper on "Wire Resistances at High Frequencies". Buzzer practise followed the speakers, after which the audience adjourned to several local stations for DX parties.

c4DE and c4DF gave an interesting talk on the design and construction of short wave tuners, while c4DY spoke on the short wave transmitter and on transmitting circuits in general. The Vigilance Committee report showed that in six cases of reported amateur interference the trouble came from other sources.

The W.R.T.A. News Bulletin has a steadily growing subscription list. The subscribers are selling ten raffle tickets each for 25c each to raise funds for continuing the Bulletin until it gets a big subscription list. A Monarch three tube, three circuit set goes to the lucky winner. If you want to see a live "ham" sheet better subscribe to the Bulletin.

MASSACHUSETTS—Worcester County hams had a blow-out Feb. 27 at the rooms of the Worcester Radio Association (1BKQ) at the Y.M.C.A. Numerous visitors from Springfield, Palmer and Plymouth were present. D. M. Cushing was the chief speaker of the evening and gave the gang some good dope. A lot of new amateurs were present and the evening was taken up with talks and hamfesting.

MICHIGAN—The Kalamazoo Radio Club meets every Wednesday afternoon and interesting meetings are planned for the future with crystal-control experiments and demonstrations. Join us at 911 Lay Blvd., Kazoo, OM.

MINNESOTA—Last month we mentioned the radio service inaugurated by the St. Paul Dispatch-Pioneer Press and the St. Paul Amateurs' Club. Here is the message blank which is placed at stores in different parts of the city for transmission via A.R.R.L.

MONTANA—Constituting itself jury, judge, witnesses, and prosecuting and defending attorneys, the Butte Radio Club held its last regular meeting in Judge Carroll's courtroom instead of at the regular club rooms. Willson and Carroll presented extensive arguments prosecuting Ground Current and Sun Spot for interfering with radio reception. After the court session Mr. Denison of M.I.T. entertained with vocal selections, telling the results of the Tech Phantom Radio Dinner, and outlining the communication courses of the Boston school. The secretary read interesting letters from prospective clubs asking information from the Butte organization on its nation-wide success.

NEW YORK—The Radio Club of New York University is on the air daily from 8 a.m. to 10 p.m. EST. With six operators, 2ACW, 2BAW, 2APB, 2AFN, Brunner (CZ) and Charlop (LC), and two transmitters working on 20-40 and 200 meters with a flock of 209A's, 2CCL is hitting on all six cylinders. A nifty shack is located on the roof of Washington Square College.

PENNSYLVANIA—From many sources we have had favorable reports on the big hamfest put on Friday evening March 12 in the Pittsburgh Post building, Pittsburgh, Pa., by the Amateur Transmitter's Association of Western Pennsylvania.

TEXAS—The Bexar County Radio Club gave a supper at the Original Mexican Restaurant and elected new officers for the year. Conroy of San Antonio is leaving to go back to sea as an "op". A bunch of new brass-pounders are filling up the ranks, so the club will carry on.

ON IMPROVING OPERATING

By C. R. Stedman, 9CAA

DURING five years of amateur experience, I have seen many messages of all kinds, some good, some bad, some indifferent. Things have steadily improved as far as the quality of messages is concerned. On the contrary, operating in general is not as good as it was three or four years ago, probably due to the many new fellows who are coming on the air nightly.

One fault in operating is quite common. How often one hears, "R ND QRM QTA." The second word directly contradicts the first. "R" means ALL OK. However, many fellows have the mistaken impression that it means one is hearing the signal but not necessarily getting a complete copy. Let's use "R" correctly. Not a night goes by but what some fellow misuses it with me. Watch 6RS, 9DXU and 9RR. Use "R" the way they do. Remember: "R" means, "your whole transmission was correctly received".

Another surprising thing is that many operators fail to keep a record of who they get a message from and who they give it to. About a quarter of the tracers I sent after messages recently were returned by some fellow with the explanation that he didn't know who he gave the message to. Make a note of the call, time and date right on the message when you acknowledge it, deliver it or send it to another station and get an acknowledgment.

For summer work, it becomes a problem to kick thru the QRN. Have you ever noticed that some stations are easier to read than others with almost an identical signal? Note these stations, and notice the heavier "flat". It makes more of a difference than you might think!

If you can copy the other fellow when he sends "single" save his and your time by telling him so. Never send "double" anyway unless it is specifically requested.

There were some mistakes and omissions on page 45 and 46 of April QST. There are five sections of the Atlantic Division under the caption "four sections." There are four sections of the Delta Division—Arkansas should send us a nominating petition for her Section Communications Manager. The Hawaiian Section of the Pacific Division was unintentionally omitted. The three sections of the Southeastern Division are as follows:

1. Florida. 2. Alabama. 3. Georgia, South Carolina, Porto Rico, Cuba, and Isle of Pines. There is still time to get in your nominating petitions for Section Communications Managers before May 15. Send 'em along.

How many fellows do you work within a radius of 50 miles? within 100 miles? Why not get a half-dozen postal cards and make some local dates over the air? Drop in at the stations across town and get acquainted. Why not get on more on 75-85 and 150-200 meters on Sunday afternoons for local work? Why not do some work like 4JR and 8CEO's (mentioned elsewhere in these columns)? An Old Timers' Week (also called Rag Chewers' Week) has been suggested. What do you think of the idea, OM?

We thought we had picked a winner when we mentioned 6BJX-pi1HR schedules here last month. We did. They have now been going six months without a break.

But for a mark to shoot at we call your attention to this one. 8CEO (McAuley of Oakmont Pa) and 4JR (ADM Morris-Gastonia, N. C.) have had a regular schedule for two years and four months (March 23, 1926)!!!! The original QSL card responsible for starting the schedule was submitted and has been returned to 4JR. A complete log of the work is available, too! The schedule is still going strong. If anyone can beat this we want to know about it in detail. Hats off to 8CEO and 4JR, everybody. Their operating is worth copying, too. Listen some night and start schedules of your own with the good stations you hear. Make some real friends by radio—the DX cards will take care of themselves.

Expeditions Again

Elsewhere in this number is announced the fact that the Byrd Arctic Expedition, SS Chantier, KEGK, has gone North. Besides keeping her daily schedules with NKF and 2ZV she has already been in touch with a number of amateurs. 2CXL worked her on 37.5 meters reporting signals "r3". Sgt. White of 2CXL adds that they will try to keep in regular touch all the way North including the time the Chantier spends in Norway. When YOU work KEGK drop us a card for Headquarters records. Be sure to forward messages you take just as instructed by the operator of KEGK. There will be some confidential press messages to be forwarded to the New York Times, night press rate and collect.

Wilkins Arctic Expedition. KFZG and KFZH, use 30, 40, and 80 meters. The messages go only to the NORTH AMERICAN NEWSPAPER ALLIANCE. Don't forget the proviso in your operators license regarding SECRECY OF MESSAGES!

The George Palmer Putnam Expedition will leave for Etah Greenland about June 1. This expedition will be about four months, depending on amateurs for general communication. 8FJ (Manley of Marietta, Ohio) will be chief operator in charge of the short wave outfit. The information regarding call, wavelength, and schedules will follow through the Official Broadcasting Stations, in bulletins and in QST. Who will be first to connect with Manley?

The Amundsen expedition will attempt a flight to the Arctic with a lighter-than-air machine. The dirigible Norges will carry long-wave radio equipment. We hope to have word that she can also work on short waves as this will be such an added assurance of good communication and consequent safety for the explorers.

9X1 is emphasizing the use of the following standard practices which all amateurs would do well to follow: 1. Adoption of cable-count as explained elsewhere in this number of QST. 2. UNLESS ASKED TO QSZ everything is sent SINGLE. 3. When important numbers, wavelengths, or complicated words occur, the operators emphasize the correct spelling and insure accuracy. The expression is

followed by "I I ?" (.) after which the expression is repeated. This is standard procedure in correcting mistakes in transmission also.

South American IAB and IAC say that they will not work an American amateur who is below the lawful wavelength band because this encourages interference with South American work. This is a reason for being sure you are within one of our assigned wavelength bands—to keep your record with the Department of Commerce clean is another—to keep your license from being suspended or cancelled by the Supervisor is a good third.

Mr. F. H. Blake, 8BRG, sailed for England on the Empress of Scotland April 13 taking a 30-110 meter receiver along. He will be glad to listen for any of the gang. Regular tests will be carried out with SAMY. 8BRG will be at Goring Hotel, Ebury St., London England until mid-July.

A few of the nominating petitions for the different Section Communications Managers have already been received. In some cases there is only one candidate for the office. This note is just to call your attention to the fact that the call for nominating petitions closes May 15. Be sure to read the notice in last

month's QST and to get your choice approved by five League members and in our hands before election time.

It is reported from reliable authority that 1HE-1ZY, speed merchant of the section of Boston is now 4MH as he, Wally Battison was married to one Miss Fay Leone Watkins at Jacksonville, Fla. April 3rd. Good luck, OM, and don't forget to teach her the code so 4MH can be continually on the air.

5WK suggests that all amateur stations in cities having a broadcasting station set aside two hours each week for gathering applause traffic through neighboring amateur stations. When there are several amateur stations in a city, a two hour watch at different stations EACH night will take care of the messages. He suggests 80 or 175 meters for this work. Why not get in touch with your local newspaper and the broadcasting station director, writing amateurs within 50 miles arranging schedules and asking them to take proper steps to get this traffic? Don't forget to let us know how it works so we can report it here, OMs.

Mr. Gronow, a3WG, Melbourne, Australia was guest at a recent C. R. T. A. meeting. We repeat some of his remarks that may be of general interest. "You fellows should be proud of QST. We pay 4c for it, but it would be cheap at \$1.44. The fellows at home all get QST. Meters, condensers, tubes and licenses are hard to get hold of.....your message relaying, army and railroad work certainly make amateur radio more interesting.... I wish we had the privilege of handing other than experimental messages. If any of you fellows come to Australia, make yourself known to any amateur and I can assure you of a good time."

3CGS has been ordering cattle for Porto Rican 4KTI He is on 40 meters using an H tube with S tube rectification. Speaking of practical uses for amateur radio tie this one! Messages handling and friendly contacts are certainly putting plain DX to shame, these days.

From the Minnesota Radio Bulletin (with apologies to 9BNK), "Wouldn't it be great if 9ZT would say, "Come on over and pound brass—and use your own call." That's what we say, too. Wouldn't it?

Effective March 30, 4NKF was shifted to 41 meters (7316 kc's). Officers and men of the Communication Division, U. S. N. R., Seventh Naval District, are requested to have both transmitters and receivers on the 40 meter band for all future drills. Most everyone is on the air on drill nights without fail. FB!!!

Official Broadcasting Stations

THE attention of the membership is again called to the League's broadcasting system.

The latest news and schedules are made into broadcast which is sent each operator of an Official Broadcasting Station weekly. The broadcast has a

release date slightly later than the mailing date so that the material to be sent can be in the hands of each operator at the beginning of the week of release no matter in what part of the country he is located.

Each station listed is putting the broadcast on the air on scheduled time and wavelength to the best of its ability. The operators of the various stations are willingly giving their time to this work. They will appreciate it if you will drop them a postal card saying that you copied the Official Broadcast Message from them on schedule, and we will be pleased to have any suggestions from you regarding ways of making this service through the Official Broadcasting Stations of more value to you.

OFFICIAL BROADCASTING STATIONS CHANGES AND ADDITIONS

(Local Standard Time)

Call	7.00 pm	10.30 pm	12.30 pm	Days of Transmission	Days of Week
IBFT	39		39	Sat.	Sun.
ICKP		39		Sat.	Wed.
IOC****				Fri.	Sat. Sun.
1XM*				Fri.	
2AGQ	81		39.5	Wed.	Fri.
2APV &					
2CQZ	Special schedules on 40, 80 and 180 meters				
2CTH	19			Mon.	Thurs.
2CTH****		38		Sun.	Thurs.
2WR	39.5			Every night	
3ALE	84	84	84	Mon.	
3ALE	84		84	Sat.	
3ALE	84			Wed.	Fri.
3BWJ	40			Mon.	Wed. Fri.
3LL	37.9			Tues.	Sun.
3XAN**					
WOAX***					
4TR	42.1	84.9		Mon.	Wed.
4TR		42.1		Tues.	
		84.9			
5ACY &&	38.64			Tues.	Thurs.
5ACY	38			Wed.	Sat.
5ACZ	39.6	39.6	39.6	Tues.	Thurs. Sat.
5ADA	37.5			Sat.	
5AGN	38.7	38.7		Fri.	Sat. Sun.
5GJ	83			Mon.	Thurs.
5ZK	81.5			Tues.	Thurs. Sat.
6BJX ???	40	40		Mon.	Wed. Fri.
6CCT				Sat.	Sun.
6CUX		38.5		Sat.	
6CUX	5-6 PM	38.5		Mon.	Wed.
6CUX	4:30 PM	38.5		Fri.	Sun.
7DF	37.5			Sat.	Thurs.
7NT	39.5	80		Wed.	
7OY	38			Mon.	Fri.
7UQ		38		Mon.	Fri.
8AUL	39.5			Tues.	Thurs. Sat.
8AKI	78		78	Mon.	
8AKI		78		Wed.	
8AKI \$\$\$		78		Sat.	
8BEM	40	80		Sun.	Wed.
8CEO	78			Mon.	Wed. Fri.
8DOO \$				Mon.	Wed. Fri.
8ZE		38		Tues.	Thurs.
8ZH	76			Mon.	
8ZH	155			Fri.	
8ZU			38.5	Sat.	
8ZU	38.5			Mon.	Wed. Fri.
8ABK	40			Tues.	Thurs.
9ADE	40	40		Thurs.	
9ADR			20	Sun.	
9APE	78			Mon.	Thurs.
9AIM	40			Mon.	Wed. Fri.
9AYK	41.4		41.4	Tues.	Thurs.
9ATO	80	80		Mon.	Wed. Fri.
9AGL	80	40		Mon.	Thurs.
9BFG	81			Mon.	
9BFG		81		Mon.	Wed.
9BXG	80			Tues.	Thurs. Sat.
9BKR	40			Daily	expt Thurs.
9BKJ	82			Tues.	Thurs. Sat.
9BUK	38			Wed.	Fri.
9BMR	37.5	37.5		Mon.	Wed. Sat.
9CJS	165		80	Tues.	Fri.
9CUR		58		Sat.	Sun.
9CFI	40		40	Mon.	Wed. Fri.
9DP \$			40.5	Sat.	
9DWK	200			Tues.	
9DWK		200		Sat.	
9DOA	85			Sun.	Fri.
9DPJ	82			Mon.	Wed.

9DPJ			41	Sun.	
9DME	42.6	42.6		Fri.	
9DZI	76.8			Tues.	Fri.
9DZI	39			Sat.	
9DZI			39	Sun.	
9ECC	38			Wed.	Fri.
9EGU	37.5			Mon.	Wed. Fri.
9EHT		38	21	Tues.	Fri.
9EHT			21	Sat.	
9HP	38	38		Wed.	Fri. Sat.
9KZ		80		Wed.	
9KZ			150	Sat.	
9RH	37.1	37.1		Mon.	Fri.
9RR		82		Tues.	Thurs.
9TJ	80			Sun.	Wed.
9TJ		40		Mon.	Wed.
9ZC		85		Sat.	
c3AFF&&&					
c3AZ	41			Tues.	Fri. Sun.
c3EL	52.5			Mon.	Wed. Fri.
c3EL ??					
c4BT	40			Fri.	Sat.
c4BT		52.5		Wed.	
c4DE*				Sat.	
c4DE		52.51		Wed.	
c4GH????				Wed.	Sun.
c4GT			37.9	Sat.	
pr4JE	38			Tues.	Sat.
?	7-7.30 pm.				
??	41 meters 7.30 pm.				
???	6 pm daily except Sunday—40 meters				
????	11.30 pm—80 meters.				
?	38 meters—12 m.				
?	40.5 meters—9 am Sunday.				
?	78 meters at midnight and noon Wed. & Sat.				
?	37.5 meters—Monday—7.30 pm—10 pm Thurs.				
?	84 meters—7.15 pm—Sat.				
?	12 pm—42.8 meters—Sat. Sun.—52.5 meters—11.30 pm Wed.				
?	11.05 pm 40 meters.				
?	1 pm Tues. & Fri.—40.5 meters.				
?	12.20 pm Thurs. Fri.—240 meters (voice).				
?	6.00 pm—83 meters.				
?	19 meters—12 am Sat. 2 pm Sun.				

The sectionalizing of the Dakota, Hudson, North-western, and Rocky Mountain Divisions and of Canada will be announced as soon as we have word from your respective Directors.

A NEW IDEA

1AUF originated the name of a new organization, The Maine Message Pushers' Club. 1BIG keeps the roster of member-stations complete and up-to-date. 1AYJ, 1AAV, 1ADI, 1KL, 1BNL, 1ATV, 1AUF, 1BTQ, 1AWQ, and 1BIG already belong. 1VF, 1BTT, 1ARV and 1SO have signified their intention of joining soon.

Every Maine amateur who will make a schedule or regular schedules with other Maine hams and who will handle traffic coming or going according to the rules of the A. R. R. L. Communications Department, is eligible for membership. The club's slogan is, "Every Maine ham a member of MMPC." More fellows are getting interested daily and message totals are on the increase. A complete list of schedules will soon be forwarded to each member by 1BIG.

Club members consider it a crime to send "double". The Bangor gang are getting interested and joining up, too. The best contact between the MMPC and the Queen city club is through schedules with 1KL on both 40 and 80 meters.

This shows how GOOD TRAFFIC MEN GET TOGETHER. The idea is spreading rapidly and schedules are functioning in wonderful order, connecting all Maine cities to a number of out-of-state points with good service.

1A1 is expected to start a Maritime branch of the MMPC covering the Provinces. Just at present he is busy taking 1BIG's European traffic and passing it to "Ole Joe" (1A1R) who shoves it along. We hear unofficially that weekly traffic routes are being lined up in parts of the Central Division.

This is mighty fine business. Such a net work of stations interested in reliable traffic handling ought to be kept in running order covering the entire country. It requires good supervision to put it over—a matter which is in the hands of your ADM or SCM. We are for it and if you are interested, too, be sure to drop a postal to your ADM and to Headquarters. Whenever there is sufficient interest in an activity, a way is found to put it over. In addition to expressing your interest in traffic-handling on the postal be sure to list the wavelength of your transmitter. Headquarters wants to see branches of the MMPC

Brass Pounders' League

Call	Orig.	Del.	Rel.	Total
9SE	31	12	750	793
3BWT	105	57	256	412
6BJX	102	107	146	355
6ANO	42	4	294	340
1ATJ	21	50	238	309
8CFY	267	27	6	290
6DAI	119	114	49	282
5YB	96	147	22	265
8EU	23	17	204	244
8XE	21	9	212	242
9BAY	229	5	2	236
9XI	42	30	156	228
pi-1CW	66	44	112	222
8AYP	12	69	140	221
9DTK	97	24	86	207
9DKS	137	54	14	205
1BIG	45	5	147	197
9BFG	37	26	125	188
9CDV	56	19	107	182
1AYJ	41	11	120	172
4DM	80	78	6	159
9ALM	51	53	52	155
3ABS-BAY	150	1	—	151
c8NI	68	62	20	150
9LX	43	28	76	147
6AFF	84	37	25	146
3BQ	7	4	134	145
2CDH	35	10	100	145
6BUC	134	5	4	143
3ZO	3	—	126	129
9LJ	10	8	106	124
1HJ	3	1	114	123
4JR	3	25	94	122
1ATV	103	12	1	116
9CZC	1	1	111	112
1YB	17	19	75	111
9AAE	54	50	3	107
1LM	3	4	100	107
9BOB	2	2	102	106
9CZL	1	79	10	105
9CTN	9	84	12	105
1YC	70	6	28	104
1AMZ	53	22	29	104
c8FC	46	47	10	103
6HJ	16	12	74	102
4BL	11	24	66	101
4GY	12	27	62	101
5ARB	88	—	12	100
5QZ	36	22	42	100

This month we have a little bigger B.P.L. We thought the Traffic Trophy had gone this time—but ND. 9SE was unable to produce his message file and disqualifies according to the Seventh Edition, ARRL Traffic Rules and Regulations, Standard Practice Rule 6, which states that only messages which can be produced, subject to the call of the DM or ADM shall count in the monthly report. 3BWT is next in line and gets the starred rectangle this month with 6BJX and 6ANO in close second and third places respectively.

While all message reports are accepted on the honor system, we must call attention to the fact that contestants for a valuable prize should keep their files in good shape ready for call, in fairness to the other contestants.

 E. W. Doane—3BWT
 132 Tennessee Ave. N. E.
 Washington, D. C.
 Orig., 10; Del'd.,—Ry'd., 1012; Total 1022

St. Paul Dispatch-Pioneer Press

Free Radiogram Special service by arrangement with St. Paul Amateur Club and

THE AMERICAN RADIO RELAY LEAGUE, Inc.

RECEIVED RADIO STATION STATION PHONE

No. Time STN. Located at Date Time Check Operator

From Date Via

To

Be sure to insert the correct time.

Sent

No. Time STN. Located at Date Time Check Operator

NOTICE TO ADDRESSEES: The station delivering you this message will be pleased to forward your reply without charge.

DIVISIONAL REPORTS

ATLANTIC DIVISION
E. B. Duvall, Manager

DUE to the changes in the League's Traffic organization, recently made by the Board of Directors, this will be my last report for the Division. The Board action calls for the sectionalizing of the Division. As announced in April QST, the old traffic organization will continue to function until the Division has elected its officers. Everyone can report as usual. The ADMs have been requested to compile the reports and send them to Hartford so they will appear in QST. In discontinuing my duties as Division Manager, I am free to take a rest from the paper work and can give more of my time to the operation and maintenance of my station and to my personal affairs. The Radio Association of Western New York, at Buffalo, N. Y., will engineer the convention. The programs so far submitted to me promise one of the greatest conventions the Division has known. While I am abandoning the idea of continuing the Atlantic Division Monthly Service Bulletin, and refunding the contributions so kindly offered, it is my earnest appeal to every man in the Division to attend the Division Convention. The Buffalo boys are going to show you a time that you will never forget or regret.

MARYLAND—3AGS on as regularly—3OP occasionally. 3LL worked England. 3SF worked Z and A stations with an indoor antenna. 3MF has forsaken the transmitting game for the camera. (How about some pictures?—DM). 3BMO uses phone on 83 meters. 3QT's 500-watt set still works good. 3GT has QSY'd to 40 meters. 3PH gets out equally well

in any direction. 3AHA is QSO foreign stations. 3AAM has turned Commercial operator for the time being. 3LG gets on occasionally doing his usual FB DX and traffic. 3OU will be on soon. Ex-3IB has a neat 40-meter set using an H-tube. H. S. Steinauer, a pre-war ham, and commercial op, will be on the air soon. 3WF has tired of 180 meter phone. He is ARRL A-A representative of the Third Corps Area. 3DQ is Radio Editor of the Baltimore American. 3BUR and 3PS are keeping things "ship-shape" at Annapolis. 3WA is doing wonderful work on 40 and 80. 3AEA is looking after a BCL outfit at WBAL. Traffic: 3CGC 52, 3CJ 10, 8VI 14, 3RF 4, 3PU 3, 3ACW 7, 3AIB 12, 3HG 24, 3DW 9.

SOUTHERN NEW JERSEY—In Raser's territory, traffic totals were good. All stations are showing good activity. All ORS reported this month except 3DH. Some new stations have been recommended for ORS. 3ABF is a good ARRL man, running a true "ham" station. 3BFH keeps Trenton QSO the world. 3RE has gone to 40 meters. 3BF is down on 80. He is one of the last of the 150 meters gang to dash down where the waves are low. 3HW has been rigging up a short wave antenna system. 3ZI has "canned" his 50-watter in favor of low power. 3SJ blew his lil' ole V.T.-2 and is going in for higher power. 3SK handles a lot of west coast traffic using only a UX-210. 3DH is on regularly taking part in the PRR emergency tests. 3BTQ works England most every night after supper with his new H-tube. 3KJ has gone into the radio business for himself. 3BWJ reports that the South Jersey gang have a set running at the Camden Radio Show.

FB. Filson reports from the 8th that 3ABS and 3BAY stood watch at the show in the ARRL booth.

Traffic: 3XAN 24, 3BTQ 25, 38J 25, 3CBX 8, 3BFH 19, 3JL 42, 3BWJ 2, 3VX 2, 3ABX-3BAY 151, 3JW 69, 3CO 6, 3BEI 16, 3KJ 8.

DISTRICT OF COLUMBIA—3BKT dropped from 80 to 40 meters. 3JO lost a tube and with it his interest in ham work. However, he found another tube and is back again. 3BWT with about a dozen 'ops' sure is pounding brass and is a station Washington is proud of. He has two transmitters on the air on 40 and 80 respectively. 3ASO and 3ACM were among the few newly appointed ORS in the city. Traffic: 3BWT 412, 3AB 38, 3HS 20, 3ASO 15.

EASTERN PENNA.—3ZO oiled up a good total and changed his wave to 40 meters. 3AUV was heard in Hong Kong. 3CHG continues to work the world. 3CHG worked 5 continents in two evenings, besides handling PRR work. 3BQP is trying a copper tubing lead-in. 3EU says his new YL won't cut his traffic totals. CM Bell says wait 'till next month. 3CCQ is still DXing. 3CGZ had some pre-4th fireworks when his plate transformer blew. 3AIY shifted to 40 metres. 3LW is another world working contender. 3NP, 3AFP, 3AVK, 3CGZ and 3MS are recently appointed ORS.

Traffic: 3AIY 5, 3LW 3, 3ABH 2, 3JN 14, 3FS 4, 3AWT 2, 3CGS 7, 3ZM 5, 3BLP 27, 3BQP 10, 3CHG 17, 3AUV 31, 3ZO 129, 3EU 244, 3CGZ 22, 3AVK 14, 3AFR 10, 3BPE 18, 3WH 9, 3BQ 145, 3BR 8, 3BSZ 44.

WESTERN PENNA.—3BRC reports on 81 meters that he handled some PRR emergency tests. He has schedules with 3CEO, 3GI, 3GU, 3ACE and 3XE every day. Needless to say, his totals are good. 3CPE will be on the air soon, on 80 and 40 meters using a 304-A tube. He is with Westinghouse at Sharon, Pa. Traffic: 3BRC 31.

WESTERN NEW YORK

3ADG, the Club president, recently returned from the 2nd district convention. He was QSO BA-1 this month. 3DDV worked a mile on phone with a WD-12. 3CYB is a new station. 3DSM announces that June will see another operator at his station, as he is going to be married. 3BCW says 3AOZ is working hard to establish an OBS. 3CPE, our newest ham, has been pushing his wicked 201A's on 40 meters with great luck. 3BQB is now at 207 Clyde Ave., Jamestown, N. Y. 3BHM is moving. 3BSF and 3CTX are back again. 3BQ handled PRR tests. 3UL has a schedule with 3FW. 3PJ is back with a new transmitter. 3HJ is active in PRR work. 3VW is working locals and states that several new stations are under construction. 3ADM reports not much traffic. He kept schedules with a-20S from March 1st to 13th with one night missing. 3DME failed to make his Hertz antenna work properly, so uses a vertical with a ball at the end. FBI 3AHC will be on again soon. 3CZP is handling traffic on low power. 3BIN and 3AWP have been off with the Flu. 3CTL has been off due to sickness, too. 3CNX almost made the BPL. 3DX had better luck with his 7 1/2 watt than with his 50. 3CNH did good with a 7 1/2 watt. 3BQK is pounding out on a '50.' 3DRJ worked Europe. 3DX and 3AVJ handle traffic with a 50 watt. 3ARS and 3AIL are doing fine work. We are recommending them for ORS. 3BGN knocked off a First Grade Commercial ticket. He has schedules with 3XAN, 3BPL, 3BTH and 3AFB.

3DSI handles his traffic with a 201-A. 3BEN uses a UX-210. 3BLP's AC got to Australia. He is using an indoor antenna. 3CNT reported for 3BOE. 3ABX is saving up for the convention. 3BZU-3EZ worked Germany, Italy and Spain. 3BOZ saved the tube but burned out his plate transformer. 3DFK handles traffic and has daily schedules with 3JN. ORS appointments are in store for 3AQK, 3AKS and 3AHX. Traffic this month is on the climb again as nearly every station reporting did its part.

Traffic: 3DX 5, 3DRJ 22, 3BQK 39, 3CNH 14, 3DXE 87, 3AKE 19, 3AIL 12, 3AVJ 6, 3HJ 8, 3BGN 45, 3BLP 2, 3DSI 7, 3DH 18, 3BEN 9, 3DFK 4, 3UL 18, 3QB 17, 3CTK 7, 3BSF 5, 3CNX 98, 3ADM 11, 3DME 56, 3CZP 16, 3BQB 2, 3BHM 27, 3BSE 5, 3CTX 7, 3DSM 27, 3ADG 4, 3AOZ 8, 3AKS 29, 3ACZ 18.

WESTERN PENNA.—Dist. 5—3DOF works his brother, 3ABZ, quite regularly. 3AYD is on. 3XE is busy with DX and BRR work.

Dist. 6—3DOQ is on the air nearly every night. 3BES is handling gall the PRR traffic in and out of Altoona. 3BAA is working for a BCL store and does

most of his key pounding at 8BES. 8DRA is off the air and wants to sell his fone. 3CCI is working on 3750 KC. 3AHK is off the air at present. 3AKI works once in a while with 15 watts on 3750 KC. when he can get away from WFGB. 3AS, the portable of 3AKI, is being rebuilt for the summer for the Ford.

Dist. 7—3CUI reports some traffic and says he is rebuilding his transmitter. 3AIC will be on the air soon with 7.5 watts. 3BZC is getting out well and handles some traffic. 3DRB bought WTAC's generator and expects to work a fifty with it soon. 3ABW is going strong but no traffic as yet. 3AUD bought a pair of 250-watt jugs and expects to use them on fone. 3BYI and 3AKI had a hamfest at 3BYI. 3BYI is still going strong on 40 and 80 with a fifty but not much traffic.

Dist. 9—We slowed up this month without doubt. Perhaps our club hamfest put a lot out of business. 3GI leads the district again but the DS gave him a close run. 3BRB is still busy with school work but is not out of the game by any means. 3CDV says that 3BKY and 3BBP have gone to Florida. 3BRM also reports. 3CWT worked 52A (QRA?) right off the bat. 3CKM is trying to get enough voltage for his 250 watt. 3CES is still looking for schedules with 9's, 5's and 4's. 3DLI is busy with garage work and wants his ORS cancelled. 3AGQ is training operators, offering prizes for best progress. 3AUC is helping out with PRR traffic. 3BBL reports regularly and handles some traffic. 3CEO has put in a 203-A and increased plate voltage. 3CGF is anxious for his ORS certificate. 3DNO is keeping schedules. 3DNF reported by long distance telephone. 3HY wants an ORS. 3CRK is getting a new tube. 3GLV blew his "250." 3AGO is handling PRR emergency work. 3BHL has a new aerial up and will be going soon. 3OW has another aerial up. 3DIO is grinding quartz crystal with no luck.

Traffic: 3GI 91, 3CIO 78, 3DNO 23, 3ARC 17, 3CDV 13, 3BRM 6, 3BBL 5, 3AGQ 5, 3CES 3, 3BRB 2, 3DOF 7, 3AXD 2, 3AEY 8, 3AJU 5, 3CTF 8, 3CC 8, 3BUY 11, 3XE 242, 3CLV 3, 3BZC 27, 3CUI 14, 3DYI 18, 3AGO 81, 3VE 15.

CENTRAL DIVISION C. E. Darr, Manager

KENTUCKY—9BUD and 9BCE are still rebuilding. 9CMW is working on 41 meters. 9CIS blew two filers and can't get the third one to "do its stuff". 9CJW is changing from two to five watters to an H-tube. Seems like that the U of Cincinnati is having trouble getting 9AMJ in operation, as nobody has heard it as yet. 9LH is about to round up a transformer. 9EP blew a fifty but got a five going—then the antenna blew down. 9BPR says 7000 volts is a "hot" rectifier problem that must be handled with care. 9EI is getting out in good shape. 9ATV is a new station. 9ALM is working on 150-200 meters and keeping schedules. 9CDN blew a "fifty".

Traffic: 9DTT 16, 9UW 26, 9HP 17, 9MN 18, 9ALM 155, 9EI 64, 9ATV 1, 9DK 34, 9OX 11.

MICHIGAN—Dist. 1 shows the worst drop this month than any previous month in two years, as no explanation comes from the ones not reporting it seems that cancellation of some ORS will be in order.

Dist. 3—3CQG is now trying the low power stuff on UV-201-A's with 45 to 150 volts of dry cells on plate with exceptional results. 3AOI is punching out a wicked signal with the H-tube. 3DGE is working a RCA-50 nearly to death. 3DSE has everything ready to go but has not burned the midnight oil lately. 3AOR punishes his pair of 6ers often. 3CVQ has a good note now using crystal-control on a pair of fifties. 3AQA has moved to Chicago and requests his ORS cancelled. 3BOK got a terrible set-back. The Radio Supervisor suspended his license till he could get a real filter built. 3DLX seems to be the only ham in Grand Haven active this winter. 3AUB and 3JG, Kalamazoo High School (Central) will soon have 3DCY going again with Weaver, 3BIC, at the helm. 3CPY is working the old fifty watt yet waiting for it to blow so as to use the new H-tube that is held in reserve. 3DKC will soon be testing every night installed in an aeroplane with an H-tube on 40 and 80 meters and will make extensive tests at all altitudes from 15,000 feet down.

Traffic: 3CPY 290, 3AUB 69, 3JG 77, 3CJT 5, 3COZ 5, 3DLX 12, 3COG 19.

WISCONSIN—9DTK has been appointed the principal Army Reserve station for Milwaukee with 9VD and 9ATO as alternates. 9DOL getting out good. 9BKR has a "fifty" perking. Also has Varsity News

schedule with 9XM weekly. 9RH hasn't found any "fivers" yet. 9BWO still using Hertz antenna and storage B batteries. 9EHM station to be out of operation until located at new QRA. 9CDT says better report next time. 9ATO hopes to be back soon again, as has received Army reserve appointment. 9CIB shot H tube and installing UX210 crystal controlled with power amplifier. 9AFZ not finished rebuilding. 9CKU burned out his lonely fiver after working m9A. That's what takes the joy out of life.

Dist. 2—9BIB have been working on crystal control for Xmitter, hence the small message total. 9BJW using 50 watter here now.

Dist. 3—9DKA expects to have a filtered sink going in near future. 9ANE says he is in bad with BCLs. 9CGL would like a schedule with a Milwaukee ham. 9CKX is using 10 watts in a coupled Hartley circuit. 9AEU is at Madison, consequently has not been on the air. 9CKC is back on the air again with five watts and on 41 meters, with AC on the plates, but reports no DX. 9EMD is busy with the tax roll and reports nothing stirring for the present.

Dist. 4—Poor reception and inactivity of stations reduced the traffic total again in this district. 9AZN had schedules with 9DTK, 9DCX and 9CM. The poorest receiving conditions ever experienced here prevailed, and on the 75-meter band in daylight communication was only possible about 20% of the time with Milwaukee and about 30% of the time with Chippewa Falls, which is only approximately 100 miles north of LaCrosse. The 40-meter band seemed to have the upper hand during the bad DX. 9DCX has not much time for traffic. 9BSO not on regularly but is working his H-tube on 40 meters. 9EIK is now reporting regularly and aims to build up his reports from now on. 9BLF is still on 40 with a fiver.

Traffic: 9DTK 207, 9DOL 48, 9BKR 24, 9RH 18, 9BWO 10, 9EHM 5, 9CDT 8, 9CKU 17, 9BIB 4, 9BJW 38, 9DKA 61, 9CGL 13, 9ANE 10, 9CKX 5, 9DKS 205, 9AGV 17, 9AZN 27, 9DCX 12, 9BSO 10, 9EIK 4, 9BLF 17, 9CAV 6.

INDIANA—Dist. 1—9QR doesn't work much. 9BKJ's note is getting dizzy. 9II was exhibited in operation at the radio show. 9DPJ got a replacement on a defective 50 watter that went west after a very short life. 9EG shot the fifty. He is seen looking longingly at 204A advertisements. 9DDA is on the air with an 180-meter fone. 9EJU shot all the receiving tubes in the place. 9DRS worked 40 most of time in Feb, but says not much doing. 9DXG still attending Dodge's Institute. 9EGZ working with a 201-A and gets out in fine shape. 9BUQ back on the air in real earnest now.

Dist. 2—9DYT is experimenting with low power. 9BK is going again. 9DHJ operates on both 80 and 180 meters. 9AEB and 9DXI were troubled with power leaks but managed to get some traffic through. 9DDZ is just back from Florida. 9CUI is a newcomer and doing good. 9BQA has just started up on 85. 9ABP is rebuilding. 9BYI goes from 40 to 80 each week end for traffic. 9OG is splitting the air as usual at South Bend. 9ASX is on 40 meters now using a new rectifier. 9CCL has "ylitis" so bad that we have given up hope. 9DLZ is now over the small-pox, so it is safe to work him again. 9DVQ, a newcomer at South Bend, uses a 201-A on 80 meters. 9CUB is married. 9AKD went to Florida. 9XE is doing experimental work. 9BUZ worked a six on his Hertz antenna and a driver. 9ABI is rebuilding. 9AWU moved his set but will be on soon. 9CP uses a Hertz antenna and break-in. 9BSK is going good on 80 meters. 9AHE worked sixes using a 5 watter.

Dist. 3—9XAH is going to rebuild 9ASMs outfit for 40-meter work. 9BEP, a new station, is going good on 80 meters. 9BSC is now working on "40". 9BW is going to replace his UX-210 with a "50". 9NG is working all the local stations at Evansville with a 201-A. 9BRK is going.

Dist. 5—9CSC handling considerable traffic on 40. 9BCM, a new station, is going good since changing to 80 meters. 9CMJ is on regularly with plenty of traffic and PRR tests. 9CMQ just bought a 203-A from 9CYQ and is getting out FB.

Traffic: 9CMJ 20, 9BCM 8, 9CSC 38, 9CYQ 22, 9ASJ 42, 9EJI 25, 9ADK 10, 9CUR 4, 9ADN 66, 9DUC 12, 9CLO 6, 9DYT 24, 9BK 2, 9DHJ 11, 9DXI 5, 9AHE 10, 9BSK 15, 9CP 5, 9CKL 39, 9DRS 14, 9AFI 13, 9HKJ 12, 9AVR 10, 9AAI 10, 9BUQ 9, 9QR 7, 9DDLN 5, 9EGZ 4, 9EJU 3, 9CXG 2.

ILLINOIS—Dist. 1—Radio activities in this vicinity are light. Brace up, fellows, and report your traffic to your proper officers.

Dist. 2—9AJM works Canada, Mexico and all but the 7th district on a fiver. 9BRX is very QRW with school work. 9ALF handled a test message from Acting ADM 9APY through station 9QD. 9ALF has a fifty working fine. 9ELR blew his tubes and is

now using a couple of 202's with CRAC. 9BUK consolidated with 9BRX some time ago. 9ARM logged South African o-3BA and also heard u-BNK trying to QSO o-A3BA.

Dist. 3—9CSW is again getting the fever and will be on soon. 9ATT is quitting the game for about a year, as he is too busy for radio. 9AHJ uses 5 watts on 80 and 150 bands—reports high waves best of all.

Dist. 4—9CLJ lost an H-tube and is getting a new 203-A. 9CZL's antenna tower blew down. 9AVH is rebuilding into a 20-meter portable outfit for summer work. 9DQU received a short report from KUDG which was anchored at Hong Kong, China.

Dist. 6—9ALW is rebuilding. 9EHQ is getting out fine on 39 meters. 9CEC got married a short time ago and hasn't had time to get on the air yet. 9DQR trying to get out on 40 and reports little success.

Dist. 7—9PI is now getting into the traffic game more than ever. 9AAW is getting out a little better and is busy with the Daily News Traffic. 9RK bought a Lizzie and slighted his radio work. 9DYL says there are so many fellows on the air that he doesn't hear the same station twice. 9CEJ worked and now has a schedule with z2AC. 9NV tried out a Hertz antenna with little success. They are on 40 meters at 9NV. 9AAE has installed a telephone in his shack for quick SN and delivery of messages. 9CXC has empty socket trouble. 9DYD hasn't missed a Saturday night on the air since last Sept. 9APE has two fivers now and a nice motor-generator. 9IX is back again on the air with a kick, and does fine PRR work. 9AIZ has come back to life. 9BVP has trouble getting his four coil Meissner working on 80. 9EIN reports every month but is bashful about turning in his station news. 9DWH is on 20 meters Sunday afternoons, while his weekdays are taken up with school work. 9DDE has been sick. 9ALG is now going strong on 40 meters. 9BBA is going to go abroad. 9AMK is now on the air at Earlville, Ill., as 9DAX. 9PU is experimenting on antennas. 9AOA, during his spare time, helps the news hams get on 40 meters. 9AER is off the air at present. 9CSB is the new city manager for the North Shore suburbs and Chicago. 9DPL reports DX very FB on 40 meters with a 210, but is only on the air during the week-ends. 9DDR is in Honolulu, Hawaii, using the call 6DCU (hu). 9JC is on 40 with a "350". Both operators of 9TT are operating at Armour Institute station, u9NV. 9APY's signals now are OK, as the trouble was a broken piston on the tuning condenser. 9GE still has two 201-A's on 40 and 80. 9DXK, Midwest DM, busted up 9QD's schedule with him by his going to the Board meeting at Hartford. 9CIA is on somewhat spasmodically. 9DLG pokes a wicked signal on the high waves. 9DDZ burned up an SCA power transformer. 9CYS gets out nicely. The Chicago Daily News in conjunction with the Chicago Radio Traffic Association, has inaugurated a free radiogram service and NO "greetings" messages are accepted. 9RWS is going down to 20 meters soon. 9ALK is busy with school work.

Traffic: 9IX 147, 9AAE 107, 9CZL 105, 9QD 89, 9APY 73, 9NV 72, 9PI 44, 9FJ 39, 9CJL 36, 9DDE 34, 9PU 31, 9RK 27, 9DXG 25, 9DYD 25, 9DLG 24, 9AOL 22, 9NK 21, 9DSS 20, 9AJM 20, 9BVP 19, 9EIN 19, 9GE 19, 9AFV 18, 9AIZ 18, 9DQU 18, 9DOX 17, 9PI 16, 9BBA 15, 9CEJ 14, 9CXC 14, 9EHQ 14, 9CSB 13, 9DYL 12, 9AAJ 10, 9AIF 6, 9CSL 6, 9DAF 6, 9ALJ 5, 9AAW 4, 9BRX 4, 9BWL 4, 9JO 4, 9DWH 3, 9US 3, 9ALF 2, 9ALG 2, 9ARM 2, 9AOA 1, 9CDD 1, 9ELF 1, 9BWS 1, 9ALK 25.

DAKOTA DIVISION D. C. Wallace, Manager

SOUTH DAKOTA—Dist. 1—9DDH reports working South America. 9DWN and 9BOW are the regular ops and keep schedules. 9ALN works Aussies with fine reports. 9DIY has overhauled his generator. The Sioux Falls YMCA Radio Club is building a five-watt transmitter for club use. 9CKT has a new Thordarson 3000-volt transformer on his H.

Dist. 2—9TI has been experimenting with 80- and 160-meter fone. 9DWN pounds brass at DDH. 9DAJ was heard in the Philippines. 9CBF is located at Missoula, Montana, working as forest ranger. 9DGR has a fifty. 9DXR worked five Aussies in one morning. 9RDW using an extremely long transmitting antenna on the fifth harmonic with good results. 9DBZ heard d-7ZM as loud as local stations. 9DKL is attending the RCA school in New York. 9DID moved again but is on with the big set. 9BBF endeavored to use his 500-volt MG as C-bias on the H but got it mixed with the 3000 volts with disastrous results for the MG. 9CVH still has Ylitis. 9NM has two junior ops. 9DZI finally got down on 40. 9BKB

was busy with basket ball and couldn't operate. 9CJS installed a fifty and gets better results.

Traffic: 9DDH 94, 9ALN 38, 9DIY 2, 9CKT 23, 9CJS 19, 9BBF 7, 9DZI 21, 9DGR 19, 9NM 15, 9DID 2, 9DBZ 27, 9BDW 9, 9DXR 22, 9DAJ 4 9TI 4.

MINNESOTA—Dist. 1—9CMS is figuring on a crystal-controlled set. 9ADS has a new antenna, but can't use his H-tube till he gets a higher resistance grid leak. 9AYQ sold his stuff, but hopes to be on with a REAL set soon. 9EEP now uses break-in nicely. 9EGF has been working on schedules as usual. 9ADW will have another operator soon. 9EGN now uses a UV-199 tube. 9DKR has been appointed an Army station. 9EGU was off most a month due to transmitter trouble.

Dist. 2—9DDB wishes to hear from any station wanting schedules on 80 meters. 9BNF is working on a low powered transmitter using a UV-199 tube. 9AIR is now experimenting with portable receivers and transmitters. 9DMA blew his old faithful five watter. 9CAJ returned from a trip to the West Coast where he visited several "sixes" and is now operating at 9DKR while 9CYX is operating at 9CAJ. 9BBV works a large antenna on a second harmonic. 9DJW has a new "50" and "S" tubes. 9EGG uses 250 volts of B-battery on his transmitter. 9BFO has QSY'd to 40 meters. 9COS has an H-tube on 40 and 80 meters but blew his plate transformer even though it was fused with 3-ampere fuses. 9CPO has been compelled to QRT for the summer because of too much work. 9BYI continues originating a batch of GOOD messages each month. 9EHO had the misfortune to lose his house by fire. His ham layout was also totally destroyed.

Dist. 3—9BMX has been QSO Hu, Z and A with a UX-210 again. 9DYZ works Aussies and Zedders regularly. 9BPY is busy with school and operates at 9XL 9BAY is the central station for handling radiograms via St. Paul's new free message service. 9BIS is on every morning and says he is going to push lots of traffic from now on. 9ECC, at the key every day with his 203-A. 9SE still leads in traffic handled, and gets R-8 reports from Mexicans. 9CPM put up a Zeppelin antenna and now works foreigners with ease, with 300 watts input to a 204-A. 9XI worked 87 foreigners last month. We want to encourage SCHEDULES and cut DX mention as much as possible. 9ABK is suffering from a severe power leak. 9DWO is moving and will be on soon. 9DEQ is busy putting up a new antenna system. 9DQH uses AC on his UX-210 on the 40-meter band. 9ZT says the Aussies and Zedders like his crystal-controlled outfit which puts 300 watts into the antenna. 9DGE finally shooed the jinx away from his station. He worked several foreigners. 9DAW gets out week-ends with a 203.

9BNK, newCM of Minneapolis, surely shows that he is alive. His first report was 100%, the first 100% Minneapolis report since Hector was a pup. Traffic: 9CKI 12, 9DV 23, 9CDV 182, 9CMS 2, 9CWN 55, 9EGF 65, 9EEP 29, 9ADW 52, 9EGN 85, 9DKR 7, 9EGU 17, 9CPO 28, 9DJW 3, 9EFD 8, 9EGG 1, 9MB 3, 9MF 4, 9DDB 2, 9BDW 44, 9BIY 42, 9AIR 18, 9BNF 19, 9COS 4, 9BGX 10, 9IG 8, 9ABK 24, 9ECC 26, 9CPM 14, 9BIS 2, 9SE 793, 9DQH 17, 9BNK 48, 9XI 228, 9ELJ 14, 9DGE 67, 9TZ 87, 9BMX 2, 9DYZ 7, 9BAY 236, 9BVH 15, 9UM 4, 9CRZ 19, 9APE 3, 9DHP 17, 9WI 55.

NORTH DAKOTA—9CCT is doing good work on 40 meters and handled some good traffic. 9DIG is organizing a radio fraternity at the State College which expects to be on the air shortly with a 50-watter on 40 meters and also gives a very favorable report on horizontal reception. 9AMP relayed a few messages and says that work interferes with radio. How funny, but ain't it the truth? 9CRB does not report much success on 80 meter tone.

Traffic: 9DIG 2, 9AMP 6, 9CCT 16, 9DKQ 10.

DELTA DIVISION

B. F. Painter, Manager

ALTHOUGH the Division now goes under different management, the director wishes to advise all members that he is just as much interested in the Division as before. He hopes that he will now be able to do a little more travelling about the Division and to meet the different members. He also will be glad to hear from the different members and to help them out with their radio problems. Be sure and call when in Chattanooga.

LOUISIANA—Shreveport—5AGJ tops the list this month. This is his best report so far, and we hope he keeps it up. 5ANC has decided to put his set up at home. 5ML has a super-hot working on 40 meters and up which means that he ought to hear all intermediates. 6WY has a message report of 5 this month

which goes to show that he is on the air a little more than none at all.

New Orleans—6EN reports 1 message relayed. 5QG has been compelled to remain off the air for some time past due to illness in his family. 5TQ is still working on 40 and 80 meters. 5ANC made his report by radio this month. 5UK was very busy.

Traffic: 5ANC 18 5QJ 27, 5EN 13, 4ACY 31, 4AGJ 15, 5ML 3, 5WY 5, 5EN 1.

MISSISSIPPI—Meridian—Things have slackened down in this part of the Division. Come on Mississippi and snap into the habit of reporting promptly and regularly!

Traffic: 5ARB 100, 5AKP 45, 5QZ 100, 5AGS 23, 5AEV 8, 5ANP 12, 5AU 20.

ARKANSAS—Little Rock—The R. I. visited here and found everything in the usual first-class condition. 5ER has moved to Little Rock from Memphis. There is a very live amateur organization here and they have offered a trophy to the ham who handles the most messages each month.

Traffic: 5ANN 8, 5AIP 6.

TENNESSEE—Chattanooga—4FP got back on the air with his 5 watter after burning out the 50. We are very glad to report that 4DA, who is well remembered as 5DA of the old spark days, is back on the air.

Traffic: 4DA 12, 4IB 52, 4FP 33.

HUDSON DIVISION

E. M. Glaser, Mgr.

DIRECTOR Dunn is so busy with work on the coming convention that plans for rearranging the division into sections have not yet been finished. Final plans will be announced at the convention.

NEW YORK CITY—Bronx—2ALL is doing good work. 2BRX has been off the air. The generator at 2APV went on strike. 2CVL reports to the CM of Manhattan every month!! The radio show put a lull in 2CYX but the ops are back to normal condition again.

Brooklyn—2PF and 2CLA have a lot of work to do for the convention and haven't much time to pound brass. 2BRB put across 350 words of press to Toronto for the North American Newspaper Alliance when the telegraphed lines were out of business due to a storm.

Manhattan—2FK takes the prize with 152 messages. 2EV has a schedule with 5AX. 2NZ has worked 16 countries since Jan. 1. 2ALS handled the first of the Army-Amateur messages from 4FX. 2KW is on. 2LD is waiting for a M. G. set. 2BNL has a beautiful note. 2KR is still using his indoor antenna on the transmitter. Several hams visited 2CHK during the show. 2AVE is on 80 now. 2AEV has been recommended for ORS.

Richmond—As OM 2CEP has to resign, reports will go to ADM Mardon until further notice. 2CEP is now at sea. 2ACZ has combined with 2AYO. 2AFV worked several foreigners. 2AKK and 2AKR are still on 80 and 175. 2ATQ is on 80. 2CEV is still at sea. 2CEP uses break-in on all waves but 5 meters. 2CZN has installed 8 tubes. 2AGC is now back.

NORTHERN NEW JERSEY

2WR is back on the air. 2QS has been issued some Third Dist. call. 2ABC has moved to a new QRA. 2CYW is sporting a new flivver. 2ACH has fallen for the romantic side of life. 2CGK had a brush with the BCLs and is now waiting the OK of the Inspector. 2BGI is helping 2QR get in operation. 2FR is a new station. 2AUH reports the fifty as being a better DXer than the 250. 2FC is QSO Europe regularly. 2CJX is QRW business. 2CYV and 2ATE were the only stations in Dist. 1 to report. 2CW is a new ORS. 2CDM expects to be on 40 meters soon. 2ATW is using a B battery transmitter. 2FA will return to the air soon. 2ALM is QSO all North America. 2CY is maintaining nightly schedules. 2EY reports no traffic changes. 2CQI will return to the air after an absence of 18 months. 2BBH cannot step out due to the very poor location. 2BWA is returning to his old QRA in Long Island. 2EG has an H tube perking on 80 and 150. 2CRP has started the season of rebuilding. 2AHK is working the Sixth district. Dist. 2 has a new station, 2AVF. 2BW handled six Army messages. 2CDR turns in a fine report. 2BBW and 2ABZ are to be recommended as ORS. 2AUG reports he is ready for traffic at any time on 40 meters. 2DX is maintaining Sunday schedules with 8ABG. 2CP is very busy. 2ATU is a newcomer and is desirous of an ORS. 2AEY has been QSO Indo-China. 2AGI and 2AAW

had the misfortune of shooting their 50s. 2ATK is a new station. 2CQZ is again threatening to break forth with a real fine transmitter. 2KS is very busy getting Newark lined up for traffic work. 2LZ transmitter is temporarily out of commission.

Traffic: 2BW 10, 2CY 60, 2DX 18, 2EY 6, 2FC 9, 2KS 3, 2QS 12, 2AEY 66, 2AHK 21, 2ATE 18, 2ANB 9, 2AUH 12, 2BBH 10, 2BGI 8, 2BIR 8, 2CDE 12, 2CQZ 9, 2CRP 10, 2CYV 1, 2CP 43, 2ALM 27, 2AUG 4, 2AUI 28.

EASTERN NEW YORK—Dist. 1—2AV is on 40 meters. 2CLG is having trouble getting his set working at his new QRA. 2BPB is working on a five meter set. 2AE says his second op is coming along fine now. 2AIZ blew his 50 watter. 2HS has been recommended for ORS. 2AUL will make application for ORS soon. 2KX is very QRW with work.

Dist. 2—With this report, the DS wishes to thank the fellows for their support and cooperation throughout the past year. It has really been a pleasure and not arduous to have had such a gang of willing hams to work with.

Yonkers—2CTF, 2ADN, 2CJE, 2AQL and 2AG are fooling with crystals. 85 meter fones on Sunday afternoons are all the rage when the boys get back from Sunday School. 2AAN has a schedule with 8DHX. 2AG has rebuilt his entire station. 2DD has at last solved the plate supply problem.

White Plains—2CNS nabbed the BCL who raised a riot in the local paper about the hams and now the fellow is learning the code. 2BQB manages to keep things hot. 2AAZ worked 2000 miles on a 201A after shooting five of them. 2CVN is using a UX210.

Poughkeepsie—2NW says he isn't a traffic station but the DS noticed he had a few things to say at the traffic meeting at the convention. 2APQ hooked a squeak-box onto a 201A using his untuned receiving antennae and worked into Iowa.

Dist. 3—2AGM's generator has gone bad again. 2CTH has rebuilt his transmitter. 2AOI blew one of his kenotrons. 2CDH is using two UX210s. 2ANM was heard in South Africa in daylight.

Dist. 4—2AKH's transmitter has not been working well. 2CYM has a schedule with 2CDE. 2COV lost his plate transformer and has to use a small one now. 2AUO expects to be on regularly now. 2MK is working DX regularly. 2AOX has his H tube perking. 2AGQ is stepping out well. 2AOX and 2AGQ attended the Second District Executive Council.

Traffic: 2AV 6, 2CLG 9, 2BPB 12, 2AJE 38, 2AIZ 7, 2AUL 6, 2KX 3, 2GDH 145, 2AOI 18, 2AGM 15, 2SZ 2, 2ANM 6, 2ANV 9, 2CYM 19, 2AKH 1, 2AGQ 18, 2COV 4, 2ADH 15, 2CTF 14, 2AAN 7, 2LA 29, 2DD 3, 2CNS 1, 2AAZ 5, 2BQB 8, 2ASE 2.

MIDWEST DIVISION P. H. Quinby, Manager

THE Midwest Communications Department cannot possibly be organized and put in working order before the last of May. You will therefore report as usual until that time, or until the newly elected SCM is announced. If in doubt, report direct to your ADM or DM.

KANSAS—9BHA says that he has a new 60 footer up. 9CXL and 9CPW are on 40. 9CPW and 9CLB, are on 180. 9CKV is out in Dodge City and is going to help us a lot with our QSOs west. 9BLB gets out to both coasts on 80. 9DNG QSOs the world when he gets on. 9DAL and gang at Arkansas City say that the Horizontal antenna is the best yet. 9BRD and the other hams out in Newton have gone in with the BCLs in a Radio Club. 9ACQ was heard in NZ. 9CWW is on 80. 9AYP is on once in a while and does some Australian DX now and then. Ex-9CPV is now on the Atlantic pounding brass. 9CCS was QSO O-A4V. (Stations who reported in March and are not listed here-in—report direct to your ADM hereafter until further notice. He is on the job!—DM).

Traffic: 9ACQ 1, 9BLB 20, 9CKV 61, 9BRD 7, 9DNG 10, 9BLB 29, 9BHA 4, 9CCS 11.

IOWA—9BKV keeps his schedules working in all directions. 9CZC says his schedules are FB. 9CZC ranks second with traffic handled. 9APM is working 2 five watt tubes in great shape. 9BZU says that his new location is much better. 9ACH has moved and says that the new location is FB. 9BOG is rebuilding. 9BSZ signals are heard regularly once more. 9AJL will be on the air soon. 9CVE has been on constantly. 9LA is rushing the 80-meter band. 9DXG is a newcomer and hopes to start soon. 9CVE has undertaken the work of reporting all traffic handled by stations in Des Moines. 9HK reports handling some traffic. 9AXD is on

the air as often as friend wife will allow him.

Traffic: 9BKV 186, 9CZC 113, 9BDH 27, 9BOS 27, 9DMS 15, 9CSQ 10, 9HK 5, 9AXD 10, 9CWW 2, 9EFS 7, 9DSL 20, 9CWE 55, 9LA 80, 9BSZ 15.

Gang!—this is not the way to turn in your reports. Take a look at Missouri totals. We want Orig. and Del. and Rel.—Total (DM).

MISSOURI—Dist. 1—9AOT has his crystal working. 9BEQ and 9BH are under way for crystal operation. 9AAU-ZK gets plenty of DX. 9DLB and 9DXN failed to get traffic due to irregular operation. 9NC and the SCM are trying to QSO.

Dist. 2—9BUE is down with the flu. 9BCQ has combined with 9CWZ. 9CVY worked A and Z stations. 9ARA worked A, Z and Tasmania. 9RT was off with blown plate transformer. 9DKG kept schedules with 9BUB and 9CKS. 9CRM was QRT most all month. 9AJO's license expired. 9DAE is trying to get schedules on 150-200 meters. 9DAD kept schedules with 6CGN and 9CRL. 9DIX got down to 37.5 but too much QRW outside. 9AJW kept schedules with 9BFG and 9BKV in Omaha.

Dist. 3—9BOB made the BPL this month. 9CZI reports business QRM.

Dist. 4—9RR fell out of the BPL. 9ADR handled quite a few messages. 9ACA is still sticking with the speed boys. A new ham, 9BPL handled a good total. 9ELT and 9ZT broke into the traffic column again.

Traffic: 9DUD 46, 9DOE 26, 9BEQ 88, 9AOT 40, 9AYK 14, 9AJW 63, 9DVF 15, 9CYK 4, 9BCQ 1, 9CWZ 3, 9EBY 2, 9AOB 42, 9LJ 124, 9DAD 17, 9CRM 2, 9ARA 11, 9DKG 37, 9BUE 8, 9BOB 106, 9DNJ 82, 9ADR 26, 9ACA 1, 9ELT 9, 9BPL 15, 9RR 31, 9ZD 4, 9BND 21, 9CZW 4, 9RT 7, 9EEZ 20.

NEBRASKA—Dist. 1—9BFG leads again in the traffic list. 9DXY maintains quite a number of schedules. 9DUO is again on.

Dist. 2—9BQR says he is doing a little advertising for traffic. 9CBK pounds brass when his work and YL permit. 9FM sends in an interesting report listing some good DX. 9DJ reports good DX using a 201A. 9BQC reports very little traffic last month. 9BBS, a new station, reports working on 40, 80 and 175 meters.

Traffic: 9BFG 188, 9DXY 35, 9EBL 78, 9DUH 13, 9DUO 6, 9DR 5, 9BOQ 1, 9BBS 19, 9CJT 86.

NEW ENGLAND DIVISION T. F. Cushing, Mgr.

CONNECTICUT—1ZL hopes to get the college station 1UO, in operation. 1BGC and 1CTI report being on the job and anxious for some traffic. 1CBG reports business slow on his RCA job. He is operating at home and helping a new operator to break into the code game. 1AUR is doing some real constructive work at his station. 1AOS is unable to work 1XZ as much as he would like. 1IV has been trying to find how a BCL get and a real transmitter can live in the same residence 1BHM says his best DX is Mosul. 1ADW has decided that the Early Riser's Club is the best yet. He worked 6CTN recently at 4.15 AM. 1HJ can change to any wave band between 20 and 85 meters in thirty-five seconds. 1MY reports a spring housecleaning of his set. He is in communication with Europe and South America quite often. 1AVX has been operating a phone on 80 and reports it better than the old waves. 1VY, ex-1AXN, sends in a fine report of activities for his section and no doubt it will lead to obtaining some very good material for ORS appointments and your ADM appreciates his effort in supplying the information. We welcome 1SZ to our District and Headquarters' staff. We trust your stay with us will be enjoyed.

Traffic: 1ADW 24, 1HJ 123, 1BGC 9, 1CBG 2, 1AOX 12, 1IV 6, 1BHM 50, 1MY 12, 1VY 23, 1ANE 95, 1AXN 16, 1AJO 14, 1BEZ 4, 1PE 58, 1BGQ 4, 1BLE 9, 1CTM 10.

RHODE ISLAND—Dist. 1—1AFO has a 60-jar rectifier and is on 20 meters. 1ABE is having YL and school QRM. 1AID handled a Governor's message on the Army net. It worked out fine. She got her answer and shot it back at once. 1ABP says DX is getting better and thinks it will be better in summer than in winter on 40 meters. 1BIE is still on top and is preparing for the Convention. 1ALD is using 2 UX-210's now and says he doesn't see as they are any better than the old fivers. 1H. 1BB has been rebuilding and couldn't get on enough to handle any traffic. 1BCR is running along about the same. 1AWE says he is hearing all kinds of DX but can't seem to work any. 1BCC is having trouble getting his mitter to perk on 40. 1AEI is busy with Convention work. 1BHI is getting out fine.

Westerley—Dist. 2—1CDS, "Doc," has a bunch of sick ones here that keep him on the jump. 1AAP

has sold his Xmitter to IBMG, who is a new Conn. ham. 1QV has burnt out his 5 watters and is preparing to put up a vertical copper pipe antenna.

Newport—Dist. 3—1BQD is slamming away and getting out FB on one 5 watter. He says watch his traffic total next month.

Traffic: 1BQD 17, 1BHI 3, 1AEI 2, 1BCC 1, 1AWE 4, 1BCR 9, 1ALD 37, 1BIE 9, 1QV 45, 1ABP 9, 1AID 20, 1ABE 3, 1AFO 14, 1BVB 16.

VERMONT—Dist. 1—1BBJ is shoving the Governor's messages right along. 1BEB has swapped from 80 meters crystal control to 40. 1BDX is doing along as usual. 1AVZ is on very little. There are about 5 stations in this district that are not ORS and operate very regular.

Dist. 2—1AC is on regularly again and slamming out the traffic. He has been appointed an Army Amateur station. 1AJG has also been made an A station. He wants schedules with others on 38 meters.

Traffic: 1BBJ 6, 1BEB 11, 1BDX 34, 1AC 26, 1AJG 19.

MAINE—Dist. 6 leads with a total of 347 messages. They ask the other Maine districts to watch their step. The "Maine Message Pushers Club" gets us in Traffic Briefs this month. Many stations report enrollment in the Army Amateur communication system but there are more good stations who should sign up. See if we can make this state the first 100% AAR state for the ORS. Let's go gang! Much work is being done with low power. Among those interested and having good luck are 1KL, who worked a B and a G with his 7.5 watter. 1AAV worked 100 miles with 3 watts input. 1BIG is high point man for the state this month. He is making a name for himself in Southern Maine and he sure does know his stuff. This month brings out a flock of new hams: 1BEI, 1BHH, 1CDB, 1CFP, 1FD, 1HD. Here's wishing them luck from the start.

Traffic: 1AAV 44, 1AFP 1, 1AYJ 72, 1BNL 26, 1OR 16, 1VF 11, 1UU 11, 1AUC 9, 1ATV 116, 1BIG 197, 1KL 34.

WESTERN MASSACHUSETTS—Activities in this section are holding their own. Conditions as a whole have not been favorable. Quite a number of fellows are doing exceptional work with 201A tubes in the transmitter.

Dist. 2—1AMZ is one of these. He has schedules and has been high traffic man for the past two months. 1AAE has made the acquaintance of a Texas YL. As a side line, he is teaching the code to a local girl. 1AMS is a new ORS.

Dist. 4—1PY is doing good work with a master oscillator circuit. He was the first American to work PE-6ZK in Palestine. 1APL is using a 201A with 135 volts on the plate on 80 meters. Since 1BLU has lost his stick, it is rumored around Springfield that he has also lost his ambition. Too bad, old sock. 1AWW has been busy keeping firms in Hartford on their own feet and had little time to operate. 1AEP handled a good total of traffic and was QSO some nice DX during the month.

Dist. 6—1AOF recently lost a 250 watter, but lost no time in getting back on the air. Tubes have a peculiarity in going west. 1CCP is working across the puddle with a 5 watter. He has a very nice DC note.

Dist. 7—1AQM found little time for operating and is not quite satisfied with his results. 1BKQ is on most every night. 1JE had to rebuild his transmitter. Glad to see that 1XZ is back on the air. 1AKZ can't add much more DX to his records, unless hams start transmitting on other planets.

Traffic: 1AAL 8, 1AKZ 30, 1AQM 10, 1ASU 58, 1BBP 7, 1DB 15, 1KX 14, 1BKQ 8, 1AAE 26, 1ARE 11, 1AMZ 104, 1AMS 8, 1CRZ 5, 1AWW 5, 1EO 16, 1IL 21, 1PY 27, 1APL 4, 1BLU 2.

EASTERN MASS.—1JL has the reputation of being Lynn's "snappiest traffic bound." In spite of the large number of hams in Lynn, things are far from being lively due to one reason or another. 1CD is bothered with YLities. 1AEO and 1JA both are busy with school work. 1AJC built a new receiver. 1NV is back on the active list of traffic handlers, with an H-tube. 1AAO has not succeeded in getting his usual DC from his new "sync" rectifier. Reports from those who are not ORS are not only welcome but solicited. Let's hear from you fellows.

Dist. 2—1AIR handled quite a few messages. 1AXA is installing a crystal control set. 1AVY and 1BUO are QRW. 1YC is keeping daily schedules and sent in a very good traffic report. 1GA was heard in South Africa on 20 meters. 1DI and 1CH are out for ORS. 1CH has been experimenting with antennas lately. Attleboro has a new CM. 1SE has resigned on account of his work and 1ACI has taken his place. 1RR is on again and has changed his

QRA. 1AHX is doing fine work with an H-tube. 1AHV is making a UX-210 climb a 30-foot vertical pipe antenna. 1BBM is using a UX-112. 1ALP reports no traffic on 40 but plenty on 80. 1SL is keeping schedules with 3AB and 8LP. 1CPQ is leaving the air for good. The prize for the largest number of messages handled by one station for three consecutive months is still hanging fire. "Gow" of 1YC got it for two months. 1GA got the largest total the next month.

Traffic: 1GA 32, 1ACI 10, 1AHL 9, 1AWB 12, 1NT 4, 1YC 104, 1AVY 7, 1AXA 5, 1BCN 10, 1AIR 24, 1SL 39, 1AP 41, 1OU 5, 1BAT 1, 1RF 13, 1ABA 12, 1CPQ 1, 1DI 10, 1CH 16, 1AUF 10, 1RR 2, 1BVL 18, 1BBK 10, 1CJR 6, 1LM 107, 1NV 10, 1ACJ 2, 1JL 47, 1AEO 24, 1JA 22, 1AJL 27, 1AYL 15, 1ZW 4, 1KY 12.

NEW HAMPSHIRE—1ATJ holds traffic honors this month. 1CKK is going to have a crystal controlled set using a UX-210. 1ATJ has received his Army certificate. 1BFT is about to join the Naval Reserve.

Traffic: 1ATJ 309, 1YB 11, 1BFT 38, 1AOQ 16.

NORTHWESTERN DIVISION Everett Kick, Mgr.

SPRING is quite early this year, but apparently S has little to say for the increase in volume the Aussies and Zedders are making way. Don't let spring-fever entrap you for Z and A may be worked as early as 10 PM P.S.T., with the possibility of being earlier as winter covers the antipodes. QTC should not be neglected for there is always something headed your way.

WASHINGTON—7FD, ADM—Our DM, 7FK, leads the state in traffic. He also rates high in DX. 7BB runs second by one message. 7DF takes credit for best DX. He was heard in 23 countries and worked 12 of them. 7VL and 7MP are new ORS. 7UQ heard 1MO at 4:30 pm. 7CY and 7NH blew their H tubes. 7NH put in a 31 and worked Australia. 7AB works A on a 201-A. Others working Australia, New Zealand or Hawaii regular are: 7ABP, 7DC, 7AFO, 7GB, 7DU is on with two 201A's. His QRA is Laurel Beach Sanitarium, RFD 4, Seattle. 7ADQ is now 7AW. 7KU is back. 7OY is QRW at U of W. 7OT and 7AIM are rebuilding. 7FQ says a 1000 ft antenna is FB for short wave reception. 7MZ works on schedule. 7WA is stepping out with the YLs. 7AF has a new car. Not much radio now! 7NG has a 5 watter. 7UL wants schedules. 7VR has power line QRM. 7QP has brought forth key clicks again. 7UO-HN has had his call changed several times by the R. I. 7GF is off temporarily. 7HO, 7TT, 7KO, 7AG, 7UU, 7TG, 7VN, 7EN, 7AGI, 7BO, 7OR, 7NS and 7ER are stations on more or less regularly. The ADM is checking up on the ORS that fail to report.

Traffic: 7FK 37, 7BB 86, 7VL 53, 7UQ 41, 7UO 41, 7MZ 34, 7HO 30, 7AFO 24, 7TG 24, 7VR 24, 7TT 22, 7UL 21, 7DF 17, 7KU 17, 7GB 14, 7FQ 13, 7OY 11, 7VN 11, 7NH 7, 7ABP 7, 7KO 5, 7AB 5, 7AG 3, 7OY 3, 7BO 2, 7DC 1.

OREGON—7IT, ADM—7OK of Route 2, Box 15A, Baker, Baker City, was appointed DS for the N. E. territory of Oregon. He worked GD1 using a single UX201A. 7EO worked A2BK and 7GZ in Alaska. 7AAJ moved across town with no effect on DX. 7HB using H in tuned plate and grid circuit worked y1CD, also QSO Ch. 7AC works east coast on 20 in daylight. 7OZ uses same equipment as 7HB. 7UJ complains not being on for school QRM. 7SY rebuilding. The Portland gang are only half on of the usual working force. 7AEK works HU every night. 7LQ had no special DX. 7YK is on the air when 7QD or 7IT get a chance to work the key. 7IT has been too QRW to be on but is still receiving cards from Australia. 7PP reliable "Peep" has been rebuilding so no DX. 7KY has too many miles on his fiver.

Traffic: 7AEK 22, 7OK 18, 7NF 12, 7QJ 10, 7JO 9, 7EO 8.

IDAHO—ex-7OB, ADM—7JF is doing very good work. 7GW has been away on a business trip but was able to work his own station while away. 7GX also had the same fortune to listen on his own sigs. 7YA is not on much lately. Plans are being made to run some tests with a portable from different points in the high mts. around Boise. 7SI is back at Salt Lake City engrossed in school studies there. 7PJ is working but will be on the air again before he leaves for Seattle. 7PS is busy with school work and YLs. 7QC has a set on 40 and 78.

Traffic: 7JF 67, 7QC 18, 7SI 23, 7GW 4.

MONTANA—TNT, ADM—Something wrong—for surely there is more activities going on in a large state as Montana is. 7PU has been doing some ex-

cellent work. Worked hu6AFF and kept schedules with c4AF, 6RJ and 7UL. 7ACI is using an A tube with B plate supply. 7NT only on a few times. He received a card from BE9 on his 40 m. signals. Traffic: 7PU 38, 7ACI 3, 7IT 4.

PACIFIC DIVISION

L. E. Smith, Mgr. Southern Section

CONGRATULATIONS, gang! More traffic was handled in February than has been handled in any month for the past year. 6ANO heads the list with 6DAI and 6BJX following. The new officers of the section have settled down and things are running smoothly. From impressions received from the new Communications Manager by the SM and ASM while they were at the last national convention, they think he's all right and wish to congratulate him. The SM plans to visit some of the important radio clubs in the section in the future to get better acquainted with the gang. Watch for next month's report. Something new!

Dist. 1.—San Diego is becoming more active. "Spring has come" apparently, as the Santa Ana gang are not quite "up to snuff". The YL's must be doing their stuff. 6AJM blew a fifty, substituted an amplifier tube, and worked 3 Aussies, 1 Zedder, 2 Philipinos, 1 Hawaiian, and 1 Chinaman in the next two days. 6BWY also has trouble with transmitting tubes and uses a 301A with which he has worked Hawaii and Tahiti. 6SB is trying 500 cycle plate supply. 6EC is QSO Ch-9TC thru power line QRM. 6CNK blew his fiver but will be on again soon.

Dist. 2.—This district is doing quite a bit. 6BJD gets R8 from everyone he works, no matter what QRA. 6BJX still has schedule with pi-1HR and has kept in steadily since last Sept. Pi-1CW is QSO Australia, New Zealand, the Orient and England. 6DAI has a bad power leak but handles traffic in spite of it. 6BGC works in a radio shop. 6AKW has a new copper-cable antenna that is FB. 6BKX has called the parson and the knot has been tied.

ARIZONA—Activity in this state has been good. The ASM is going out to his cattle ranch and intends to take a portable outfit along with him. 6YB and 6XAW are experimenting with 6BKA's portable loop transmitter. They are going to order a plane from Ft. Worth and do some aerial hamming. Their best DX this year is BAM. 6CBJ likes his "H" tube. 6RJT is ex-7EU and will be going soon. 6DEQ is a new active station in Phoenix.

Dist. 1.—Things are going pretty good in South Arizona. 6CUW handles most traffic and keeps schedules with BAM. 6AMZ and 6BAH are nearly ready to go with 7½ watters and B batt. plate supply. 6ANO gets lots of traffic. 6AMW, singing "VP", is second op. 6ASA makes his own bottles (Bottles of what?). 6DCQ is a new station in Phoenix. 6AAM tried 80 m. but quit. 6CAJ wants to build a set but is QRW as op of KFAD.

Traffic: 6BUR 23, 6AJM 84, 6BQ 66, 6ADT 45, 6DN 36, 6SB 20, 6BWY 10, 6BDE 9, 6CGC 4, 6CNK 6, 6CHX 3, 6YB 4, 6CBJ 14, 6DCQ 14, 6BWS 2, 6ANO 340, 6CUW 96, 6CAP 15, 6AFG 52, 6BEV 39, 6BGC 10, 6BJD 68, 6BJX 271, 6CAH 5, 6CSW 44, 6CTN 105, 6DAI 282, 6JI 5, 6RF 47, 6AKW 5, pi-1CW 222, 6CDY 24, 6HVO 15, 6CRZ 17, 6AJI 34, 6COU 6, 6NW 24, 6RN 97, 6ML 55, 6BBQ 25, 6BLS 72, 6CMQ 86, 6CGK 4, 6CAE 2, 6CQA 36.

PACIFIC DIVISION

Northern Section, P. W. Dann, Mgr.

The traffic report for this month for the State of Nevada shows a leaning toward more stations and activities along traffic handling. Thanks, fellows, for your splendid cooperation. An agreement has been reached between the Managers of the Southern and Northern Sections relative to the numbering of ORS certificates. The Southern section's ORS will bear the letters S.S. before the number and number from 1 to 3,999, while the ORS's of the Northern section will bear the letters N.S. and run from 4,000 up. There will be no necessity of re-numbering, as the Manager of the Northern Section has been placing N.S. on all ORS certificates issued by him. Your ORS will be recognized in the Southern section as well as the Northern section.

CALIFORNIA—Dist. 4.—6OI seems to be the outstanding station in Dist. 4. 6MP now at U. C. and has reconstructed the set and hopes for DX. 6ADB, now on forty, with a "fifty". 6CIS works east coast every night. 6CVD on soon with an MG set. 6BVY using two UX-210's and has worked O-A3E as pi-3AR. 6BVY says the one control receiver is sure the berries. Dists. 5 and 5A.—6CEG is installing an "H" tube. 6VK, 6WP, 6CQG, 6CAU are temporarily off the air

but will be back soon. 6SR will be off until next Sept. as well as 6SZ. 6OC-6BEX, new ORS, handed in a big traffic report for the month. 6BMV is installing a new "50". 6ALV is doing fine work on a single wire antenna. He is hearing CHs and BZs besides lots of other DX. 6CEJ has his "250" working and says DX pny7777 6RJ-6ALX, 6CMG, 6BHM are handing in their usual fine reports.

Dist. 6.—The gang up in this territory are apparently pepping up. 6SA has moved to 233 Hillsdale St., Eureka, Calif. 6SA is still waiting for "S" tubes. 6BWR is remodelling his set and aerial system. 6BAF is still waiting a replacement on a defective fifty. 6SA is on 83 meters and 6BAF and 6BWR are on 39 and 42.5 respectively.

Traffic: 6NX 43, 6BON 11, 6CKV 35, 6AMM 8, 6OI 23, 6CSX 29, 6CAI 5, 6RMW 14, 6ALW 4, 6AIH 20, 6CLP 44, 6ADB 8, 6CVD 5, 6BVY 24, 6BHM 44, 6RJ 48, 6CMG 16, 6ALX 55, 6CEJ 4, 6ALV 20, 6OC 73, 6BQC 50, 6IM 23, 6BBJ 35, 6GU 16, 6CLZ 12, 6BFU 2, 6ANW 72, 6EW 4, 6CTX 21, 6BIN 22, 6CUL 15, 6CDX 10, 6HH 4, 6KW 45, 6CCR 13, 6HJ 102, 6RW 19, 6VR 36, 6CHE 1, 6CLS 14.

NEVADA—Activity in this section has increased greatly during the last month and we look for even better next. There are three active stations in Reno and a promising one in Elko, Nev., which would assist greatly in relay work out of Nevada. 6GA, 6AJP have been using a L.C. Hartley with a fifty but changed to a four coil Meissner and have worked all Districts and Alaska with 200 volts on the plate of an old 201A amplifier. You high-power hounds please take note the fellows who are using ordinary amplifier tubes are doing. At last 6ZO is back with us again. 6UO was QRW with Flu and Mumps, so did very little traffic work. The report for the month is FB.

Traffic: 6GA 62, 6AJP 23, 6UO 2.

Hawaiian Section, K. A. Cantin, Mgr.

6AFF's report shows that it pays to operate in an efficient manner and to observe the rules of the communications Department. He was QSO with a 120 different stations with a DX of over 2000 miles for each station. All U. S. districts, P. I., China, Australia and other points were worked during the month by 6AFF. His traffic handling, delivery and total is FB! Numerous mainland stations route their traffic for points east of Hawaii via 6AFF.

The Radio Club of Hawaii Station 6BUC has an excellent staff of "old time operators" on the job every night during the week. Schedules can be arranged with 6BUC for handling traffic, for the operators will take all the traffic mainland stations originate. 6RUC sends out the weekly ARRL broadcast on Friday night at ten P.M. Hawaiian Time on 40 meters.

6CFN has been appointed an ORS. Two operators sign "SD" and "WF". Night under the antenna of NPM, they receive considerable QRM from arc mash and are forced to do most of their work when the arc is out.

6CLJ in addition to his traffic work has been experimenting with low power DX. With a "fiver", he has been QSO Ch-31J, Japan, and U. S. stations. He is trying to work Africa and establish a new low power record.

6CST worked A8TM with daylight at both points. Schedules were kept with U-6BB, 6RW, GAS and RAM. 6CST has been experimenting with plate supply and has an excellent note. 6AJE left for the mainland for a two month business trip. He plans to put in an H tube. 6TQ has QRM from a power leak and does most of his work before 7 P.M. Hawaii time. 6AJE signed up as operator and left for a trip around the world.

6DCF worked several African stations and gets thru in fine shape. He worked KFUH now in New Zealand water. 6CFQ is a new station on the air. 6DBL and 6CMH are both QSO the mainland. 6BCG was heard in Kansas while experimenting with a 5 watter. He plans to move to a new QRA soon and put in a new transmitter.

Traffic: 6AFF 146, 6BUC 148, 6CFN 53, 6CLJ 21, 6TQ 18, 6CST 14, 6AJL 6.

ROANOKE DIVISION

W. T. Gravely, Manager

WEST VIRGINIA—The month's work shows the usual activity. 8AYP again leads in messages. Several hams joined our ranks, applying for ORS.

Wheeling is represented by 8AUL and 8CDV, who are most active. 8BSU installed 500 watts self-rectification on 40. 8BSK, showing activity. 8CAY, doing the usual good work. 8SP is bringing ORS into the limelight. 8BJG works sixes and sevens

very often. 3CQH changes to 8SV. 8IT ex-9AKE, reported in England. The Huntington gang seem to be the most consistently active bunch in the state. 3AMD experimenting with crystal-controlled set with self rectification and DC circuits. 3AUL reported buying a crystal.

Traffic: 3AUL 34, 3CDV 15, 3BJG 11, 3BSU 2, 3APY 221, 8IT 14, 8ATC 13, 3DRR 18.

NORTH CAROLINA—Dist. 2—4TS says there will be a signal corps station on 40 at Canton soon. 4OU is on occasionally. 4BJ is planning to have 110 volts AC installed and should have a good report soon. 4MI has been on very little account of sickness.

Dist. 2—4JS was home from school for a few days and worked O-44L, taking a message for Headquarters. 4RY has sold his junk and will not be heard from again until he finishes college. 4BX is helping move WBT and is on the air at times. 4AC is getting out fine on his 210, England and sixth districts. 4JR is moving loads of traffic.

Traffic: 4TS 9, 4BX 15, 4RY 51, 4JS 8, 4JR 122. **VIRGINIA**—3MK handled a message from Europe to second district. 3CKA doing fine PRR work on 80. 3UX expects to drop to 40. 3QF failed to designate how his messages were handled according to latest instructions. 3AHL is wearing mourning—his "50" passed into the land of "CQ-less" tubes.

3CJU had to give up the game account of school. 3AFX gone south. 3TT's fiver still kicking. 3BNE now on SS Cretan. The second operator at 3BNE met with an accident and is in the hospital.

Dist. 2—3BMN says interest rising but activity slow. 3SG now at 4CE. 3ATB is at Miami, Fla. 3AUM will come on the air with a 7½ watter soon. 3BMU threatens to come on the air with an ether buster. 3AEV sent in a report—first one for more than a year from Richmond. 3AJR in hospital but was working one fiver on 40 and 80. 3AIK is on 80. 3AEV is blowing five watters and working between blows.

Dist. 3—3BGS got going all right at last using B-battery supply. 3RL works a few locals on 168. 3CFY has been unable to reach out on the 80 band. 3RX reports working more with experimental station than handling traffic.

Dist. 4—3BZ reports no traffic handled but the usual activities of that station. 3CKL has hard time getting an aerial that will suit him. 3BDZ is on the air now and working a few stations as time permits.

Traffic: 3BNE 12, 3MK 4, 3CKA 4, 3UX 10, 3AHL 39, 3TI 62.

WEST GULF DIVISION

F. M. Corlett, Mgr.

GET out your April QST, turn to page 45, note carefully the notice of nominations and elections of our department. You have until May 15th to file your nominations. As your retiring Division Manager, I want to see a number of nominations for each Section. Nominate active men, men that, if elected, will make you excellent leaders and organizers of your Sections.

Your retiring D. M. wishes to take this opportunity to express his sincere appreciation for the excellent cooperation and assistance rendered by each and every ADM, DS, CM and members of the West Gulf Division. Probably it is unnecessary to state that I do not care to accept, nor will I accept at this time, any Communications Department nomination. I have been in the harness a number of years as your traffic head of this division, I have worn out a number of "collars" and some "breaching," and I feel that should I continue in the "harness," more "breaching" than "collars" would need replacing. Serving you fellows, my brother "hams," has been a pleasure.

OKLAHOMA—5PU is grease monkey in a garage and says that everybody seems to have the spring overhauling fever and that same reflects in his traffic total. 5APQ is lonesome as there are no hams in Blackwell where he was called on business. 5QL has a 204A perkin' on 40 meters. 5AAV tied up with a BZ bus says he would rather QSO Arkansas to complete his home states' QSO. 5ATK can't seem to rouse up enough pep to build a receiver to match his 7½ watt transmitter. 5AQT is a new station and worked all the US.

Dist. 4—5AJM has a schedule with 4MV every Sunday morning. 5AGO is to QSY to 80 meters.

Traffic: 5ABO 5, 5AQW 25, 5APG 10, 5PU 5, 5ANL 22, 5ADO 28, 5APQ 6, 5QL 10, 5AAV 15, 5ATK 1, 5AQT 4, 5SW 1, 5ATV 10, 5ATO 28, 5ABZ 18, 5ATA 30, 5AGO 2, 5AJM 10.

NORTHERN TEXAS—Considering the time of the year, activity has about been normal. 5APM is back

on the air after rebuilding. 5EW reports that he is still very QRW. 5HS sends an interesting report of the activities of the Bexar County Radio Club. We have with us this month a newcomer, 5ALH-5ALA of Mirando City. 5ZAI is still going good. 5MS is at the hamfest at Dallas. 5DW's set is still perking.

Traffic: 5DW 2, 5APM 3, 5ZAI 30.

NEW MEXICO—Four messages were handled by 5ARN this month. There are four active stations in "Cruces," 5AK, 5AGU, 5AGP and 5ARN. All are using fivers and they to perk fairly good. 5AGP, 5AGU and 5ARN tried the Hertz antenna and it works FB. Pole raising is quite the thing, the gang having been collected to raise one three different times after it had been laid low by those New Mexico gentle (?) spring breezes.

CANADA

MARITIME DIVISION
W. C. Borrett, Manager

NEWFOUNDLAND STATIONS DEVELOPING FAST. MARITIME CONVENTION AT ST. JOHN THIS YEAR. NEW STATION IN HALIFAX AND WEDNESDAY NIGHT PRAYER MEETINGS ON 525 METERS POPULAR.

The most encouraging state of affairs for the DM is the conditions in Newfoundland, and the DM is glad to report that he has been QSO with three Newfoundland stations and has heard a fourth pounding away. The three who have worked us are 8AR, 8AW and 8WM. The other station heard on the air is 8AZS. This is a splendid showing and it is hoped that before long many more will follow these pioneers of our sister colony. The New Brunswick gang are holding this year's convention and by the time this report is in your hands it will be in full swing. 1EI, 1AK, 1AF and 1AM are the leading spirits and they are cooperating with the St. John BCL to try and make some more ARRL members. The DM is very glad to announce that Dr. Ritchie, President of the Nova Scotia Institute of Science, has purchased the equipment for a short-wave transmitting set, and in addition to having the regular plate supply, he has a large block of Edison cells for some low-power tests. We are delighted that the Doctor is getting into the transmitting game and look for some good dope from him at some later date. 1DGG, Elliot Campbell, our division news manager, is the leading spirit in attendance at our Wednesday night prayer meetings, and any stations wishing to get QSO with him will just tune in around midnight on Wednesdays on 62.5 and will find him there. The New Brunswick gang have been busy this month with the convention and as a result have not done much traffic handling. 1AM, 1AI, 1AD and 1AK being heard most. We regret to announce that 1AW is leaving the Maritime division for the USA. 1ED is taking his place as District Supt. in those parts until the new organization takes place in the division. 1CX of Glace Bay is by far the most active ham in his district and deserves special mention for his promptness in reporting each month. 1DO of St. Andrews has been doing some special experimental work which we hope to get particulars of in the near future. 1DD is using a horizontal receiving aerial and thinks it fine business. 1DQ, our latest ORS, has again lost his tubes, hence the silence this month.

Traffic: 1DD 13, 1AK 10, 1AM 2.

ONTARIO DIVISION

W. Y. Sloan, Manager

ADM OF NORTHERN ONTARIO, 3NI, AGAIN CLIMBS INTO BRASS POUNDERS LEAGUE, AND IS JOINED THIS MONTH BY 3FC.

3AL ENJOYS FONE QSO WITH C-1AR DURING DAYLITE, ON TWENTY METERS.

NORTHERN ONTARIO—ADM, W. M. Sutton—"Whasamatter" fellows? The ADM sends you long letters giving you dope on transmitters, and never hears from you again. Two or three stations are doing all the work, and, although our district is large, and rather sparsely populated, still we should be able to boast more than three active stations. LET ME HEAR FROM YOU FELLOWS! No word this month from 3GG about the OR's son's portable set, but keep a weather eye open for his sigs, as it is believed he has left for the open spaces. (How cum keep "eye" open OM, guess he must be using a Hertz, eh? HI—DM). 3HP put one over by working two Toronto stations on his 201-A, input .06 watt using 52.5 wave. This was done without the aid of higher power, or another station for the first QSO. Vy FB, OM. 3NI

outdoes last month's record, and climbs into the BPL's again. 70% of his traffic was between 3NI and Toronto and was only due to the fact that a permanent schedule was kept with 3FC. Considerable traffic of great importance has been handled for a large corporation, and on twenty meters contact was maintained one afternoon from 1 to 6 pm solid. 3NI has obtained a new Iesco M G, which will greatly improve his QSB. This report was handled by radio, through the courtesy of c3FG.

EASTERN ONTARIO—ADM, F. A. C. Harrison—No reports received this month other than the activities of the Ottawa stations. 3GJ changed his call to 3JL and thought he was fooling the gang with his new call, but they were wise to this, and had the laugh on him. 3KT is reaching out in good shape now. 3AEL has been appointed as the new CM of Kingston. Hop to it, OM, and let us hear from you of the activities in the "Limestone City".

SOUTHERN ONTARIO—ADM, J. A. Varey—3DH is high man again this month, and has plugged in a fifty water. 3KA QRW school and is rebuilding. When he re-opens 3KA will be crystal-controlled. 3KO has been heard again. Welcome, OM. 3KP is keeping up his wonderful work, and is figuring on getting into the crystal-control game. 3MF has been missed lately, but claims no YL excuse. 3VW on 40 reports traffic poor, while 3ABG using a 50 on 85 flat complains of the same thing. 3ZD is QRW school, but is heard on fone on 80 occasionally. 3ZB is on steadily and is getting the 52.5 habit. 3GY, 3IA and 3XI all fail to send in any report this month. What's the trouble fellows? A little action PLEASE.

CENTRAL ONTARIO—ADM, A. R. Williams—3FC is the star station this month, leading the way with 103 messages handled. 9AL has his new set going with plenty of juice, and has worked the east coast on fone using 20 meters during daylight. Glad to hear 3NJ back again; he signaled his return by working P.R. on a fiver. 3MV is back with a bang, and working Mexicans and P.R.'s galore, using a Hertz antenna. 3BR has his new 250-watt jug perking nicely, and works east coast in daylight on 20. He claims the big bottle shimmies nicely on 5 meters. 3BL using 150 volts of Edison B's, and 3DR with flivver coil IGW, are two new stations that we welcome on the air. 3UR has moved to Toronto from Galt, and is getting on the air immediately. 3EL and 3AZ are heard banging away steadily, while 3CK is very QRW, and only gets on occasionally. 3BJ has been concentrating on 52.5 and most of the traffic is handled on this wave. The "quart bottle" is burning until daylight every Saturday night. 3VH is heard occasionally with nice QSB. **NO REPORTS FROM ANY OUT-OF-TORONTO STATIONS. WHAT'S THE MATTER WITH GALT, KITCHENER AND GUELPH?**

Traffic: 3NI 150, 3FC 103, 9BJ 51, 3MV 18, 9AL 17, 3DH 17, 3BY 15, 3NJ 14, 3EL 14, 3BR 13, 3VH 2, 3HP 10, 3AZ 8, 3JL 8, 9CC 5, 3FU 5, 3AFP 3, 3CK 2, 3KA 2, 3XM 2, 3ZB 2, 3KT 1.

PRAIRIE DIVISION F. E. Rutland, Manager

SASK—4HH is on the air with a 250. Charlie Banting of 10AB has a baby burgess. 4BF using an H-tube gets out. Saskatoon will soon be on the map with 4BG. 4AC exchanged sigs. with a Z, and has now got new 1500-volt dynamotor and expects to be QSO regularly; on the air every Sunday afternoon 2 to 5. 4GH is on 80. (Try 52.5 sometimes OM). 4CE upsets the odd BCL using a Mullard 150 water, but expects to form a radio club and get a 10 Amateur BC License. 4BQ has been having hard luck with his 5 waters but has been getting out well. 4AQ is pounding a mean fist and getting out in all directions on 80 with 2 201-A's with 200 on plate. Dad Maynard. 4CB, can't cut the tails off his dots, but is getting out fine QSO Eastern Hams regularly on 52.5. 4HS is on and is getting good results with a couple of 201-A's on 80. 4AA is knocking large chunks out of the other occasionally.

MANTOBA—Traffic handling is on the increase and would be on an even larger scale if the difficulty of good short-distance QSO on short waves at night could be overcome. The fact that a few western stations can be raised on 52 meters is also a handicap. 4DE has cut his big aerial down and is using fundamental transmission. He handled some important traffic for the Tribune Pine to Palm Tourists. 4DY and 4EA have also used the pliers to good advantage. 4BT is the champion traffic handler this month. He has had his call changed from 4LC. 4DU finds 13 on the filament of a 201-A is not so good, and put in a fiver. 4AW blew the works early in the month, but you can't keep a good man down, he is back with a new

set of tubes and a fine QSB. 4DY has a new CG-1144A and is handling traffic on schedule with five points. He would like to arrange schedule with a c-5. 4BK is busy throwing a Schnell together. 4EA says the Aussies come in FB. 4DW is the champion brass pounder on 20 meters, having worked all districts in daylight on one fiver. FB, OM. 4DF has trouble with his QSB on 40 meters although very FB on 52 and 80 meters.

Traffic: 4EA 10, 4LC 36, 4AW 2, 4DF 4, 4DY 14, 4DW 17, 4DE 8, 4BF 2, 4HH 23, 4AC 10, 4AQ 29, 4CB 2.

QUEBEC DIVISION A. Reid, Manager

WELL, gang, the boys have elected me as J.C.A.'s successor. We are all very sorry that Jack had to resign on account of business pressure. No one has ever worked harder than 2CD for the success of the second division, more especially during the First All-Canada Convention. We all owe Jack our thanks and appreciation for his good work and trust that he will find time to be on the air and keep up his DX work as before.

All the old appointments are cancelled and the DM is now asking for applications.

All up, Gang, let's make this a banner year. Say, boys, isn't that 52.5 meter band of ours great: the attendance is increasing at every prayer meeting, in fact every night. There is a lot of traffic moved on this wave.

The Hamfest at 2AX's station on February 27th was well attended, 23 hams being present. The first auction took place and proved to be very interesting and humorous. The boys sure got rid of a lot of junk, nearly \$15.00 changed hands during the sale. 2VB Sr. made an excellent auctioneer. Another gathering of the clams (hi) took place at 2AL's station (by the way, 2AL is one of the newcomers to the game and is doing excellent work). The auction which is now a regular part of a hamfest was a huge success. The attendance was 22. 2AX is busting the eardrums of the foreigners nearly every evening. 2CG ex DM worked 22AC for nearly an hour March 16th and made tests from 37 to 42 meters, and found equal strength over the entire band.

2BG is putting more pep into his antenna lately, tried fone on low waves and worked c1AM in daylight. 2BT, 2DO, 2EV, 2HT, 2HV, 2AU, 2CB and 2AZ are on mostly every night, and doing good work. 2BE has a new transmitter. 2CB is home from sea and has rebuilt his transmitter. He is one of our regulars on 52. The following appointments have been made:

2EV, J. E. Dussault, CM for Montreal.
2BV Sr., C. H. R. Bird, ADM Westmount and Notre-Dame de Grace.
2DO, James Bowman, DS.

VAN-ALTA DIVISION A. H. Asmussen, Manager

IT appears that msg. totals are on a par with DX conditions this month viz poor. The recently appointed DS for the coast was called to sea as an opr. and 5GO has been appointed as his successor, and judging from his first report he is going to be FB for the job and has also set a mark for Canadians to shoot at by working AQE. 5AK is back on the job again and worked c1DD right off the bat. FB OM. 5AS is making an occasional splash in the ether, but where is your report this month? What about your ORS (DS). 5CR reports little this month, due to sickness. 5GF is still kicking and also a "Kicking Still" (DS). c5BB is a newcomer and we hope to have them in the form of an ORS and they will keep a schedule and I don't mean maybe. We need more reliable ORS, not enough on the air. 5GT is using two fifties in parallel and gets R-10 reports. 5AW hears Italy, England, etc. on one tube, his QRA is Whitehorse, Yukon. 5CT on the Island can always be heard with a very good DC note on 40 and 80. 4AH is the most reliable station in Edmonton on 40 meters looking for traffic. 4CL is rebuilding. What's matter with 4JF, and 4HF? 4BH finds it hard to raise anyone. 4BZ is doing nice work on low power, FB, OM. 4AF is a new ORS—is sure doing good as a traffic clearing station and hands in a fine message total. 4AL, though working very good DX on low power, had a slump in msgs. handled—he had to mail one to the DS. 4DQ handled a fine bunch of msgs., most of them in daylight with the OW at the wheel. The OM is doing missionary work and has two prospects learning the code, also building up for the 52-meter prayer meeting. 4GT is QRW selling oil stocks but still keeps the hook clear. 4IO still holding the Fort on 80 but

reports DX and traffic poor. The AREA gang meet in Calgary the fourth Tuesday of every month and gaining ground each meeting—write to 4AX, the secretary. There are a number of stations in this division who have not applied for ORS—do you realize the value of this OM? You cannot expect to be mentioned in this report unless you hold an ORS certificate, therefore get busy and put in an application and get as many other prospective hams interested in the ARRL as possible. Many of the BCLs would build up an xmitter if you would just show them how easy it is to get on the air even if they start with V-201-A tubes in their transmitter, and for an example, the DM worked A-3QH and was surprised to learn that the Aussie was using only one 201-A in his transmitter, and such an outlay would cost very little more than a one or two tube receiving set, so get busy, gang, and get as many prospective hams and BCLs on the air even with only one 201-A and more power to them. Some of the hams in this district are making records with just such equipment.

Traffic: 4AH 2, 4AF 16, 4AL 2, 4DQ 12, 4GT 13, 4IO 4, 4SA 11, 4CR 9, 4GF 5, 4GO 31.

ROCKY MOUNTAIN DIVISION N. R. Hood, Manager

COLORADO—Denver—9CJY reports that a great many of the gang are not getting their reports in on time. Your reports must be in his hands on or before the 15th of each month if they are to appear in QST. 9CAA leads Colorado this month. He is operating on 40, 80 and 175. 9EAM has several schedules to help things along and is on every night on 80. 9DED did some wonderful DX in the form of working 9EEFY, 5 blocks away.

Dist. 1—9DVL has been getting out very good on a 201A and loop aerial. 9AOI was on only 8 hours during the month but put through some pretty good work.

Dist. 2—9BDF is now operating at Rico with the old standby—the bed springs—for aerial. 9DFH is experimenting with horizontal antennas. 9CHT has moved to Arkansas. 9CHD, a new station, is doing fine work after the customary trouble getting started. 9EAE is now back on the air regularly. 9ADI, 9CFY and 9DUI report as usual. 9DFH expects to close his station for the summer soon as he will be in other parts of the country. 9ODE is on steady.

Traffic: 9DVL 80, 9AOI 37, 9CDE 17, 9ADI 55, 9EAE 5, 9DUI 52, 9DFH 11, 9CFY 12, 9OO 27, 9EAM 62, 9WO 9, 9CAW 10.

UTAH—Salt Lake City—Only a few stations were on this month. 6BTX turns in the largest traffic total. 6RV had a little hard luck with his H tube and so is operating on his fiver until he is able to replace the other. 6RUH reports that he has obtained a sine motor and hopes to get it rigged up for a sine rectifier and be on the air once more. 6RM sold his set last month and as yet has nothing on the air. 6ZT has been out of town.

Ogden—6BUV handled a total of 16 messages. 6FM is working on 76 meters. 6CRS handled traffic with Honolulu.

Traffic: 6BTX 47, 6RV 16, 6FM 15, 6BUV 16, 6CRS 29.

WYOMING—7HX remains the mainstay of northern Wyoming. He reports biz a bit on the bum but traffic moving good. Two new stations have opened up in Casper, TNY and 7DW, and both are on 40 meters. A new station has opened up in Rawlins, 7CZ, with two H tubes.

Traffic: 7HX 44.

SOUTHEASTERN DIVISION A. D. Trum, Mgr.

SOUTHEASTERN Division amateurs are stepping on the gas! The fellows are not only doing excellent DX work but are handling traffic like veterans. Florida hams are notified to send their reports to Mr. W. F. Grogan, Box 816, Ft. Myers, Fla., who has been appointed ADM to succeed Mr. E. A. Rosseter resigned on account of pressing business.

ALABAMA—A survey of reports shows that interest has been somewhat greater during the past month. An increase in traffic handled speaks for itself. The hams in the state have been doing some visiting. District 4 leads the state in traffic handling, while Dist 2 runs second. 5YB at Auburn, handled the largest number of messages with 5AX, 5DL and 5AWF fighting for second place.

Dist. 1—5AX with his 50-watt bottle did the outstanding work for the month. He handled his traffic on regular schedule with several stations. Ex-4FB is operating with 5AX and they are certainly doing their stuff. 6VU can be heard once in a great while. Some promising new material has been found. We hope several new stations will be on before long. 5ARJ is now using a 50-watt and can be counted on for some good work.

Dist. 2—A big increase in traffic can be noted, which shows the boys are on the job. 5DL has been in daily communication with Chicago and has been handling important traffic for a representative of the G.M. & N. RR. 5QF has broken the ice on 40 meters with a "river." 5QF happens to be a cartoonist and designed an excellent cartoon on the subject of wavelength outlaws. We wish it would reproduce here. 5AC worked O-AEE for an hour March 10th. 5AC relayed 5 messages from Clinton, N. C., to Ft. Meyers, Fla., in 18 minutes. 5DL is now on the air doing fine work. 5QK still holds his pace and works all the foreigners as usual.

Dist. 3—5ADA leads the district. His school work lets up week-ends, so he sticks with the old brass and handles traffic. 5AJP gets on for a few minutes nightly but his duties as DM take up most of his leisure time. 5ATP has had transformer trouble lately. 5DI takes over the job of Supt. of Dist. 3 with headquarters at Auburn, Ala., so he resigned as Selma CM.

Dist. 4—Things have certainly happened at Auburn this month. 5DL, a new DS of Dist. No. 4, is now in school at Auburn. 5YB has a perfectly good 250-watt working on 40 meters. It is reported that 250-watt bottles are being used as watch charms by the ops at 5YB. Schedules are kept with 4VQ, 4AV, 5AX and 4CU. Several new stations will be on the air in Auburn, among them is 5GP.

Traffic: 5AC 45, 5AAD 5, 5ADA 40, 5AJP 17, 5ARJ 2, 5ATP 37, 5AWF 50, 5AX 45, 5DL 45, 5QF 2, 5QK 41, 5VV 2, 5YB 265.

SOUTH CAROLINA—There are many active stations in South Carolina; all are doing good work. 4MV keeps a regular schedule with DNBW in Honduras. Almost 100% of the messages originated at 4JV were delivered. 4VQ is experimenting a great deal on 20 meters and has several schedules on the same wave. 4OY, 4IT, 4JK and 4RR-4VL are on regularly.

Traffic: 4IT 62, 4JK 14, 4JV 23, 4MV 174, 4OY 92, 4RR-4VL 23, 4AAM 11, 4VQ 140.

GEORGIA—Georgia amateurs are noted around the world for their good 'sigs' and mighty sending. 4RM is going good at his new location and is a most consistent station. 4SI is out of bed and on the air again. 4AV at Ga. Tech. handled 200 messages with 5 'ops' on duty. 4AP and 4HS are operating a broadcasting station for J. M. High Co. 5NW is on the air and big doings are looked for from him.

FLORIDA—Florida hams are going strong now with Grogan of 4QY as leader. Rosseter couldn't handle the ADM on account of business, so we lost another good man but we couldn't wish for a better honest-to-goodness ham for ADM than Grogan. Hey, fellows! let your reports come in galore next month to the new ADM. Now that Florida is settled with the leadership question, we are going smoothly again! 4KK plans to fill the air with good traffic regularly. 4DM is handling the Burgess traffic from Burgess Isle to Madison, Wisc., with Warren of 4TR-4DM at the key. 4FM, the old familiar fist of Watts, is on the air relaying messages from Michigan to France. 4UA is wiring houses but works Europe nightly with two UX-210's. 4TY, Rosseter, has been very busy but is coming on the air with a 250-watt crystal-controlled set on 82.2 meters. 4OB is handling traffic like a veteran. 4XE, at Winter Park, is doing splendid crystal-controlled work. 4XE knows his eggs. 4NKF, our Naval Reserve Station, uses 100 watts self-rectified AC and holds regular drill every Tuesday night for all Florida reserve men. NAR1, another reserve station, used for amateur work, is using a 250-watt with a "sync." 4TV is doing splendid work. 4BL of Lakeland, is on the air with an old 201-A and 900 AC volts when the Bryant brothers are home from sea. Both are commercial 'ops.' 4IZ, at Tampa, has a new 250 on the air with three fine ops. They are all commercial. FBI The gang in Miami are doing their stuff. 4GY uses a UX-210. 4QY has a regular schedule with EAR 22 and chews the rag in Spanish. 4KJ is working fine with a UX-210. Moore, of 4VS, had hard luck with moving day and blew his brand new UX at the new place. 4FM is on the air with his pretty fist regularly.

Traffic: 4TY 6, 4FM 4, 4UA 7, 4KK 9, 4DM 159, 4OB 33, 4BL 101, 4IZ 52, 4GY 101, 4VS 33.